

INTRODUCTION

In view of the recent amendment made in the Designs (Amendment) Rules, 2008 with effect from 17/06/2008, Publication of the matter relating to Designs is being published in the Official Journal of The Patent Office. This Journal is being published on weekly basis on every Friday covering the various proceedings on Designs as required according to the provisions of under Rule 22, 25, 27 and 39 of the Design (Amendment) Rules, 2008. All the enquiries on this Official Journal and other information as required by the public should be addressed to the Controller General of Patents, Designs & Trade Marks. Suggestions and comments are requested from all quarters so that the content can be enriched.

THE DESIGNS ACT 2000
SECTION 30
DESIGN ASSIGNMENT

The Design stands in the name of RICHARD CHENE, DOMINIQUE DELAMOUR, ALAIN MIKLITARIAN, OLIVIER RODI registered under the Designs Act, 2000 has been assigned in the Register of Designs along with co-proprietor's name is as follows:-

Design No.	Class	Name
198660 198661	12-08	SOCIETE ALBIGEOISE DE FABRICATION ET DE REPARATION AUTOMOBILE-SAFRA, A FRENCH COMPANY, OF, 5, RUE COPERNIC ZAC DE FONLABOUR 81000 ALBI FRANCE.

CANCELLATION PROCEEDINGS
under Section 19 of the Designs Act, 2000

“The Ld. Asstt. Controller of Patents & Designs passed an order on 03/03/2015 to dismiss the petition (Petition No. Can/003/2013) filed by Som Distilleries & Breweries Limited, having its registered office at 1-A, Zee Plaza, Arjun Nagar, Kamal Cinema Road, New Delhi - 110029 on 28/1/2013 for cancellation of registration of registered Design No. 223479 dated 19/6/2009 under Class 09-01 titled as “Bottle” in the name of Skol Breweries Ltd., an Indian company of Jalahalli Camp Road, Yeshwanthpur, Bangalore – 560022, India.”

COPYRIGHT PUBLICATION

SL NO	REGISTERED DESIGN NUMBERS	RENEWED ON
1.	192346	09.03.2015
2.	196949	09.03.2015
3.	206194	09.03.2015
4.	254574	09.03.2015
5.	254576	09.03.2015
6.	191013	24.02.2015
7.	254438	24.02.2015
8.	196847	24.02.2015
9.	196848	25.02.2015
10.	196849	25.02.2015
11.	194023	25.02.2015
12.	194588	25.02.2015
13.	194790	25.02.2015

**RESTORATION OF LAPSED DESIGNS
UNDER SECTION 12 (2) OF THE DESIGNS ACT, 2000**

(1)

An application made under Section 12 (2) of the Designs act, 2000 on **03.12.2014**, for Restoration of **Design No.196949** dated **10.09.2004** in the name of **CHIDAMBARAM ASHOK KUMAR OF J-18, S-BLOCK, M.I.D.C., BHOSARI, PUNE-411026, MAHARASHTRA, INDIA, AN INDIAN CITIZEN** has been allowed.

(2)

An application made under Section 12 (2) of the Designs act, 2000 on **02.09.2014**, for Restoration of **Design No.196847** dated **01.09.2004** in the name of **KHADIM INDIA LIMITED, AN INDIAN COMPANY HAVING ITS REGISTERED OFFICE AT KANKARIA ESTATE, 5TH FLOOR, 6 LITTLE RUSSELL STREET, KOLKATA-700071, WEST BENGAL, INDIA** has been allowed.

(3)

An application made under Section 12 (2) of the Designs act, 2000 on **02.09.2014**, for Restoration of **Design No.196848** dated **01.09.2004** in the name of **KHADIM INDIA LIMITED, AN INDIAN COMPANY HAVING ITS REGISTERED OFFICE AT KANKARIA ESTATE, 5TH FLOOR, 6 LITTLE RUSSELL STREET, KOLKATA-700071, WEST BENGAL, INDIA** has been allowed.

(4)

An application made under Section 12 (2) of the Designs act, 2000 on **02.09.2014**, for Restoration of **Design No.196849** dated **01.09.2004** in the name of **KHADIM INDIA LIMITED, AN INDIAN COMPANY HAVING ITS REGISTERED OFFICE AT KANKARIA ESTATE, 5TH FLOOR, 6 LITTLE RUSSELL STREET, KOLKATA-700071, WEST BENGAL, INDIA** has been allowed.

(5)

An application made under Section 12 (2) of the Designs act, 2000 on **10.04.2014**, for Restoration of **Design No.194790** dated **09.03.2004** in the name of **AXIS IMPEX, A REGISTERED PARTNERSHIP FIRM, AT SHOP NO.4, 83-85 DADY SHETH AGIARY LANE, MUMBAI:-400002, MAHARASHTRA, INDIA, WHOSE PARTNERS ARE 1. VELJI MONSHI SHAH, 2. KANTI MONSHI SHAH, 3. HITEN HANSRAJ SHAH & JITENDRA RAGHAVJI GADA, ALL INDIAN NATIONALS** has been allowed.

(6)

An application made under Section 12 (2) of the Designs act, 2000 on **10.04.2014**, for Restoration of **Design No.194588** dated **16.02.2004** in the name of **AXIS IMPEX, A REGISTERED PARTNERSHIP FIRM, AT SHOP NO.4, 83-85 DADY SHETH AGIARY LANE, MUMBAI:-400002, MAHARASHTRA, INDIA, WHOSE PARTNERS ARE 1. VELJI MONSHI SHAH, 2. KANTI MONSHI SHAH, 3. HITEN HANSRAJ SHAH & JITENDRA RAGHAVJI GADA, ALL INDIAN NATIONALS** has been allowed.

(7)



An application made under Section 12 (2) of the Designs act, 2000 on **10.04.2014**, for Restoration of **Design No.194023** dated **15.12.2003** in the name of **AXIS IMPEX, A REGISTERED PARTNERSHIP FIRM, AT SHOP NO.4, 83-85 DADY SHETH AGIARY LANE, MUMBAI:-400002, MAHARASHTRA, INDIA, WHOSE PARTNERS ARE 1. VELJI MONSHI SHAH, 2. KANTI MONSHI SHAH, 3. HITEN HANSRAJ SHAH & JITENDRA RAGHAVJI GADA, ALL INDIAN NATIONALS** has been allowed.

(8)

An application made under Section 12 (2) of the Designs act, 2000 on **26.12.2013**, for Restoration of **Design No.191013** dated **14.01.2003** in the name of **NANGALWALA CHEMICAL INDUSTRIES, 29-30 OLD INDUSTRIAL AREA, NEAR I.T.I. ROAD, ALWAR 301001, RAJASTHAN, INDIA, AN INDIAN COMPANY** has been allowed.

REGISTRATION OF DESIGNS

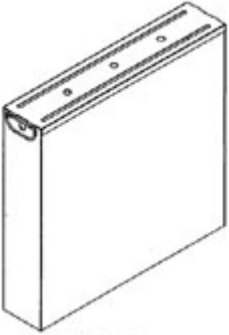
The following designs have been registered. They are now open for public inspection. In the following each entry the Date of Registration is shown. The Priority Number, Priority Date and Priority Country are also shown

DESIGN NUMBER	265204							
CLASS	13-02							
1)EXIDE INDUSTRIES LIMITED OF 'EXIDE HOUSE', 59E, CHOWRINGHEE ROAD, KOLKATA-700020, STATE OF WEST BENGAL, INDIA, AN INDIAN COMPANY								
DATE OF REGISTRATION	27/08/2014							
TITLE	BATTERY CONTAINER							
PRIORITY NA								
DESIGN NUMBER	258537							
CLASS	09-03							
1)NICOVENTURES HOLDINGS LIMITED, A COMPANY OF UK OF 22 TUDOR STREET, LONDON EC4YOAY, UNITED KINGDOM								
DATE OF REGISTRATION	03/12/2013							
TITLE	PACKAGING FOR ELECTRONIC CIGARETTE							
PRIORITY								
<table border="1" style="width: 100%; border-collapse: collapse;"> <thead> <tr> <th style="width: 30%;">PRIORITY NUMBER</th> <th style="width: 30%;">DATE</th> <th style="width: 40%;">COUNTRY</th> </tr> </thead> <tbody> <tr> <td>002249383-0008</td> <td>04/06/2013</td> <td>OHIM</td> </tr> </tbody> </table>			PRIORITY NUMBER	DATE	COUNTRY	002249383-0008	04/06/2013	OHIM
PRIORITY NUMBER	DATE	COUNTRY						
002249383-0008	04/06/2013	OHIM						
DESIGN NUMBER	262503							
CLASS	07-02							
1)DART INDUSTRIES INC., A CORPORATION FOUNDED UNDER THE LAWS OF DELAWARE, U.S.A. OF 14901 SOUTH ORANGE BLOSSOM TRAIL, ORLANDO, FLORIDA 32837, USA								
DATE OF REGISTRATION	09/05/2014							
TITLE	VENT FOR A FOOD CONTAINER							
PRIORITY								
<table border="1" style="width: 100%; border-collapse: collapse;"> <thead> <tr> <th style="width: 30%;">PRIORITY NUMBER</th> <th style="width: 30%;">DATE</th> <th style="width: 40%;">COUNTRY</th> </tr> </thead> <tbody> <tr> <td>29/473,360</td> <td>21/11/2013</td> <td>U.S.A.</td> </tr> </tbody> </table>			PRIORITY NUMBER	DATE	COUNTRY	29/473,360	21/11/2013	U.S.A.
PRIORITY NUMBER	DATE	COUNTRY						
29/473,360	21/11/2013	U.S.A.						

DESIGN NUMBER	262588	
CLASS	13-03	
1)MR. PRASHANT M. DIXIT, ADULT, INDIAN NATIONAL HAVING ADDRESS FOR CORRESPONDENCE AT C/O VIJETA SWITCHGEAR PVT LTD, E-26, MIDC, KUPWAD BLOCK, SANGLI 416436, MAHARASHTRA, INDIA		
DATE OF REGISTRATION	15/05/2014	
TITLE	CABINET FOR ELECTRIC POWER CONTROL EQUIPMENT	
PRIORITY NA		

DESIGN NUMBER	263072		
CLASS	23-03		
1)KYOSHIN KOGYO CO., LTD, A CORPORATION INCORPORATED UNDER THE LAWS OF JAPAN, HAVING ITS OFFICE AT 20-7, EBIE 7-CHOME, FUKUSHIMA-KU, OSAKA-SHI, OSAKA, JAPAN			
DATE OF REGISTRATION	03/06/2014		
TITLE	HEAT EXCHANGER HOLDER		
PRIORITY			
PRIORITY NUMBER	DATE	COUNTRY	
30-2013-0061669	06/12/2013	REPUBLIC OF KOREA	

DESIGN NUMBER	265737		
CLASS	12-14		
1)TVS MOTOR COMPANY LIMITED, AN INDIAN COMPANY INCORPORATED UNDER THE COMPANIES ACT, 1956, HAVING ITS REGISTERED OFFICE AT "JAYALAKSHMI ESTATES", 29 (OLD NO. 8) HADDOWS ROAD, CHENNAI 600006, TAMIL NADU, INDIA			
DATE OF REGISTRATION	18/09/2014		
TITLE	THREE WHEELER		
PRIORITY NA			

DESIGN NUMBER	259960		
CLASS	12-16		
1)TATA MOTORS LIMITED, AN INDIAN COMPANY OF BOMBAY HOUSE, 24 HOMI MODY STREET, HUTATMA CHOWK, MUMBAI 400001, MAHARASHTRA, INDIA			
DATE OF REGISTRATION	31/01/2014		
TITLE	FRONT SEAT OF A VEHICLE		
PRIORITY NA			
DESIGN NUMBER	265468		
CLASS	13-03		
1)YAZAKI CORPORATION, A JAPANESE CORPORATION OF 4-28, MITA 1-CHOME, MINATO-KU, TOKYO 108-0073, JAPAN			
DATE OF REGISTRATION	05/09/2014		
TITLE	ELECTRICAL CONNECTOR HOUSING		
PRIORITY			
PRIORITY NUMBER	DATE	COUNTRY	
2014-004812	07/03/2014	JAPAN	
DESIGN NUMBER	262944		
CLASS	06-07		
1)SHIVKUMAR SANGAYYA BHIKSHAVATIMATH, 'PIYUSH' BUNGALOW NO. 15, ANITA RESIDENCY, KATRAJ-KONDHVA BYPASS ROAD, KATRAJ-411046, PUNE MAHARASHTRA INDIA, INDIAN NATIONAL			
DATE OF REGISTRATION	28/05/2014		
TITLE	FRAME		
PRIORITY NA			

DESIGN NUMBER	264605		
CLASS	13-03		
1)GOLD MEDAL ELECTRICALS PVT. LTD. A COMPANY REGISTERED UNDER COMPANY ACT 1956 OF, 22/23 SHUBH BUILDING, SAGAR MANTHAN INDUSTRIAL COMPLEX, BHOIDAPADA, VASAI (E), THANE - 401208, MAHARASHTRA, INDIA			
DATE OF REGISTRATION	08/08/2014		
TITLE	TELEPHONE JACK		
PRIORITY NA			
DESIGN NUMBER	264689		
CLASS	09-07		
1)GODREJ CONSUMER PRODUCTS LIMITED, AN INDIAN COMPANY HAVING ITS REGISTERED OFFICE AT PIROJSHANAGAR, EASTERN EXPRESS HIGHWAY, VIKHROLI, MUMBAI-400079, STATE OF MAHARASHTRA, INDIA			
DATE OF REGISTRATION	08/08/2014		
TITLE	CAP FOR BOTTLE		
PRIORITY NA			
DESIGN NUMBER	258865		
CLASS	03-01		
1)FOLLI-FOLLIE COMMERCIAL MANUFACTURING AND TECHNICAL SOCIETE ANONYME, 23RD KM. ATHENS-LAMIA HIGHWAY, ATHENS, 145 65, GREECE, NATIONALITY-GREECE			
DATE OF REGISTRATION	19/12/2013		
TITLE	PURSE		
PRIORITY			
PRIORITY NUMBER	DATE	COUNTRY	

DESIGN NUMBER	262587	
CLASS	13-03	
1)MR. PRASHANT M. DIXIT, ADULT, INDIAN NATIONAL HAVING ADDRESS FOR CORRESPONDENCE AT C/O VIJETA SWITCHGEAR PVT LTD, E-26, MIDC, KUPWAD BLOCK, SANGLI 416436, MAHARASHTRA, INDIA		
DATE OF REGISTRATION	15/05/2014	
TITLE	CABINET FOR ELECTRIC POWER CONTROL PANEL	
PRIORITY NA		
DESIGN NUMBER	264912	
CLASS	11-01	
1)MANOJ ORNAMENTS PRIVATE LIMITED, A COMPANY INCORPORATED UNDER THE COMPANIES ACT, 1956 AND HAVING OFFICE AT SHOP NO. 14, SAYAM KAMAL, D WING, AGARWAL MARKET, BELOW KAPOL BANK, VILE PARLE EAST, MUMBAI 400057 MAHARASHTRA, INDIA, WHOSE DIRECTORS ARE 1) SANJAY WALCHAND JAIN, AND 2) CHETNA SANJAY JAIN, BOTH DIRECTORS RESIDING AT 301, SIDDHACHAL APARTMENT, VILE PARLE EAST, MUMBAI 400057, MAHARASHTRA, INDIA		
DATE OF REGISTRATION	21/08/2014	
TITLE	BRACELET	
PRIORITY NA		
DESIGN NUMBER	262943	
CLASS	19-06	
1)SHIVKUMAR SANGAYYA BHIKSHAVATIMATH, 'PIYUSH' BUNGALOW NO. 15, ANITA RESIDENCY, KATRAJ-KONDHVA BYPASS ROAD, KATRAJ-411046, PUNE MAHARASHTRA INDIA, INDIAN NATIONAL		
DATE OF REGISTRATION	28/05/2014	
TITLE	COMPASS BOX	
PRIORITY NA		

DESIGN NUMBER	264604
CLASS	13-03
1)GOLD MEDAL ELECTRICALS PVT. LTD. A COMPANY REGISTERED UNDER COMPANY ACT 1956 OF, 22/23 SHUBH BUILDING, SAGAR MANTHAN INDUSTRIAL COMPLEX, BHOLIDAPADA, VASAI (E), THANE - 401208, MAHARASHTRA, INDIA	
DATE OF REGISTRATION	08/08/2014
TITLE	SOCKET FOR TV
PRIORITY NA	



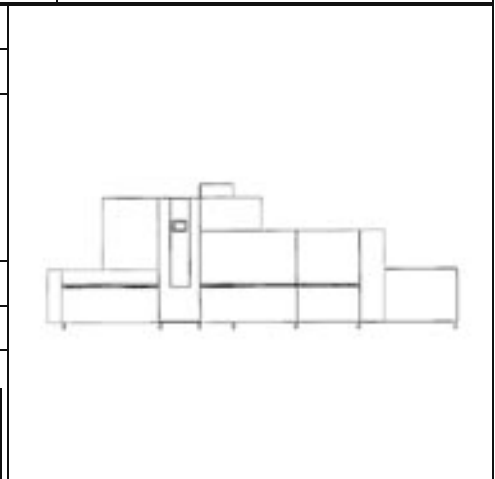

DESIGN NUMBER	262603	
CLASS	15-05	
1)ILLINOIS TOOL WORKS INC., A COMPANY ORGANIZED AND EXISTING UNDER THE LAWS OF UNITED STATES, HAVING ITS OFFICE AT 155 HARLEM AVENUE, GLENVIEW, ILLINOIS 60025 UNITED STATES OF AMERICA		
DATE OF REGISTRATION	15/05/2014	
TITLE	CONTROL CABINET FOR A DISHWASHER	
PRIORITY		
PRIORITY NUMBER	DATE	COUNTRY
1394944	19/12/2013	OHIM



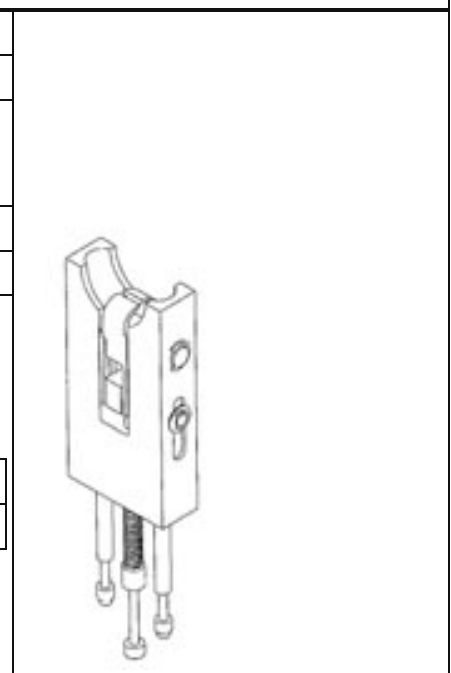

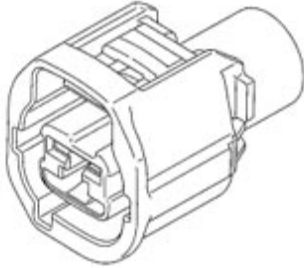

DESIGN NUMBER	263074	
CLASS	23-03	
1)KYOSHIN KOGYO CO., LTD, A CORPORATION INCORPORATED UNDER THE LAWS OF JAPAN, HAVING ITS OFFICE AT 20-7, EBIE 7-CHOME, FUKUSHIMA-KU, OSAKA-SHI, OSAKA, JAPAN		
DATE OF REGISTRATION	03/06/2014	
TITLE	HEAT EXCHANGER HOLDER	
PRIORITY		
PRIORITY NUMBER	DATE	COUNTRY
30-2013-0061679	06/12/2013	REPUBLIC OF KOREA



DESIGN NUMBER	264045		
CLASS	09-01		
1)BHASKAR YADAV AND ARVIND YADAV, (BOTH ARE INDIAN NATIONALS), TRADING AS M/S. SMOOTH PETROCHAM, DUDI BAGH, THRAWAI, SORON, ALLAHABAD, U.P.			
DATE OF REGISTRATION	15/07/2014		
TITLE	BOTTLE		
PRIORITY NA			
DESIGN NUMBER	265470		
CLASS	13-03		
1)YAZAKI CORPORATION, A JAPANESE CORPORATION OF 4-28, MITA 1-CHOME, MINATO-KU, TOKYO 108-0073, JAPAN			
DATE OF REGISTRATION	05/09/2014		
TITLE	ELECTRICAL CONNECTOR HOUSING		
PRIORITY			
PRIORITY NUMBER	DATE	COUNTRY	
2014-004814	07/03/2014	JAPAN	
DESIGN NUMBER	262946		
CLASS	03-01		
1)SHIVKUMAR SANGAYYA BHIKSHAVATIMATH, 'PIYUSH' BUNGALOW NO. 15, ANITA RESIDENCY, KATRAJ-KONDHVA BYPASS ROAD, KATRAJ-411046, PUNE MAHARASHTRA INDIA, INDIAN NATIONAL			
DATE OF REGISTRATION	28/05/2014		
TITLE	MEDICINE BOX		
PRIORITY NA			

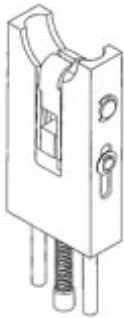

DESIGN NUMBER	260436	
CLASS	09-07	
1)ZYDUS WELLNESS LTD. SIGMA COMMERCE ZONE, NEAR ISCON CROSS ROAD, B/H GALLOPS MALL, AMBLI-BOPAL ROAD, AHMEDABAD 380015, INDIAN		
DATE OF REGISTRATION	18/02/2014	
TITLE	DISPENSING CLOSURE	
PRIORITY NA		
DESIGN NUMBER	262947	
CLASS	19-06	
1)SHIVKUMAR SANGAYYA BHIKSHAVATIMATH, 'PIYUSH' BUNGALOW NO. 15, ANITA RESIDENCY, KATRAJ-KONDHVA BYPASS ROAD, KATRAJ-411046, PUNE MAHARASHTRA INDIA, INDIAN NATIONAL		
DATE OF REGISTRATION	28/05/2014	
TITLE	PEN STAND	
PRIORITY NA		
DESIGN NUMBER	264608	
CLASS	13-03	
1)GOLD MEDAL ELECTRICALS PVT. LTD. A COMPANY REGISTERED UNDER COMPANY ACT 1956 OF, 22/23 SHUBH BUILDING, SAGAR MANTHAN INDUSTRIAL COMPLEX, BHOIDAPADA, VASAI (E), THANE - 401208, MAHARASHTRA, INDIA		
DATE OF REGISTRATION	08/08/2014	
TITLE	REGULATOR	
PRIORITY NA		

DESIGN NUMBER	265206		
CLASS	11-02		
1)AMAR SINGH YADAV, TRADING AS M/S. S. N. GLASS DECORATERS, SITUATED AT 2/778, SUHAG NAGAR, FIROZABAD (U.P.) INDIA, OF ABOVE ADDRESS			
DATE OF REGISTRATION	27/08/2014		
TITLE	FLOWER VASE		
PRIORITY NA			
DESIGN NUMBER	262506		
CLASS	07-02		
1)DART INDUSTRIES INC., A CORPORATION FOUNDED UNDER THE LAWS OF DELAWARE, U.S.A. OF 14901 SOUTH ORANGE BLOSSOM TRAIL, ORLANDO, FLORIDA 32837, USA			
DATE OF REGISTRATION	09/05/2014		
TITLE	COVER FOR A FOOD CONTAINER		
PRIORITY			
PRIORITY NUMBER	DATE	COUNTRY	
29/473,364	21/11/2013	U.S.A.	
DESIGN NUMBER	263073		
CLASS	23-03		
1)KYOSHIN KOGYO CO., LTD, A CORPORATION INCORPORATED UNDER THE LAWS OF JAPAN, HAVING ITS OFFICE AT 20-7, EBIE 7-CHOME, FUKUSHIMA-KU, OSAKA-SHI, OSAKA, JAPAN			
DATE OF REGISTRATION	03/06/2014		
TITLE	HEAT EXCHANGER HOLDER		
PRIORITY			
PRIORITY NUMBER	DATE	COUNTRY	
30-2013-0061674	06/12/2013	REPUBLIC OF KOREA	

DESIGN NUMBER	264148	
CLASS	07-02	
1)HAWKINS COOKERS LIMITED, OF MAKER TOWER F 101, CUFFE PARADE, P.O. BOX 16083, MUMBAI-400005, MAHARASHTRA, INDIA, AN INDIAN COMPANY		
DATE OF REGISTRATION	18/07/2014	
TITLE	COOKWARE	
PRIORITY NA		

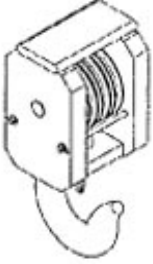

DESIGN NUMBER	262945	
CLASS	06-07	
1)SHIVKUMAR SANGAYYA BHIKSHAVATIMATH, 'PIYUSH' BUNGALOW NO. 15, ANITA RESIDENCY, KATRAJ- KONDHVA BYPASS ROAD, KATRAJ-411046, PUNE MAHARASHTRA INDIA, INDIAN NATIONAL		
DATE OF REGISTRATION	28/05/2014	
TITLE	FRAME	
PRIORITY NA		

DESIGN NUMBER	264606	
CLASS	13-03	
1)GOLD MEDAL ELECTRICALS PVT. LTD. A COMPANY REGISTERED UNDER COMPANY ACT 1956 OF, 22/23 SHUBH BUILDING, SAGAR MANTHAN INDUSTRIAL COMPLEX, BHODAPADA, VASAI (E), THANE - 401208, MAHARASHTRA, INDIA		
DATE OF REGISTRATION	08/08/2014	
TITLE	COMPUTER JACK	
PRIORITY NA		

DESIGN NUMBER	263279		
CLASS	12-16		
1)R. N. GUPTA & COMPANY LIMITED, (AN INDIAN COMPANY INCORPORATED UNDER THE COMPANIES ACT, 1956), HAVING ITS OFFICE AT UNIT-II, GT ROAD, TEHSIL PAYAL, DORAHA-141421			
DATE OF REGISTRATION	11/06/2014		
TITLE	SNATCH BLOCK ASSEMBLY FOR CRANE		
PRIORITY NA			
DESIGN NUMBER	262341		
CLASS	12-16		
1)FORD GLOBAL TECHNOLOGIES, LLC A COMPANY ORGANIZED AND EXISTING UNDER THE LAWS OF UNITED STATES, HAVING ITS OFFICE AT 330 TOWN CENTER DRIVE, SUITE 800, DEARBORN MICHIGAN-48126, UNITED STATES OF AMERICA			
DATE OF REGISTRATION	05/05/2014		
TITLE	VEHICLE FENDER		
PRIORITY			
PRIORITY NUMBER	DATE	COUNTRY	
3020130056864	06/11/2013	BRAZIL	
DESIGN NUMBER	262450		
CLASS	21-01		
1)M/S RATHI ENTERPRISES (PARTNERSHIP FIRM) AT PALA ROAD, GOPAL PURI, ALIGARH (U.P.) INDIA, THROUGH ITS PARTNERS MADHUR RATHI, BHAVNA RATHI, SAROJ RATHI & UMA RATHI, BY NATIONALITY INDIAN OF ABOVE ADDRESS			
DATE OF REGISTRATION	07/05/2014		
TITLE	TOY PISTOL		
PRIORITY NA			

DESIGN NUMBER	264050	
CLASS	12-11	
1)HERO CYCLES LIMITED, HERO NAGAR G. T. ROAD, LUDHIANA-141003 (PUNJAB), INDIA, (AN INDIAN COMPANY DULY INCORPORATED UNDER THE PROVISIONS OF INDIAN COMPANIES ACT, 1956)		
DATE OF REGISTRATION	15/07/2014	
TITLE	BICYCLE	
PRIORITY NA		
DESIGN NUMBER	260255	
CLASS	08-01	
1)HILTI AKTIENGESELLSCHAFT, FELDKIRCHERSTRASSE 100, FL-9494 SCHAAN, LIECHTENSTEIN, NATIONALITY: LIECHTENSTEIN		
DATE OF REGISTRATION	10/02/2014	
TITLE	CORE BIT USED IN DRILLING	
PRIORITY		
PRIORITY NUMBER	DATE	COUNTRY
756199601	09/08/2013	WIPO
DESIGN NUMBER	265601	
CLASS	09-01	
1)PARAMS PHARMA OF C-58, SPORTS AND SURGICAL COMPLEX, KAPURTHALA ROAD, JALANDHAR (PUNJAB), INDIA, AN INDIAN PARTNERSHIP FIRM WHOSE PARTNERS ARE RAJNEESH CHOPRA AND RAJINDERA PARSHAD CHOPRA & OTHERS, INDIAN NATIONALS OF ABOVE ADDRESS		
DATE OF REGISTRATION	10/09/2014	
TITLE	BOTTLE	
PRIORITY NA		

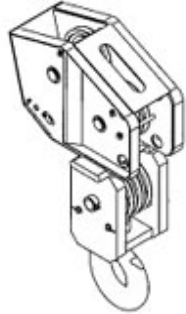

DESIGN NUMBER	264610	
CLASS	13-03	
1)GOLD MEDAL ELECTRICALS PVT. LTD. A COMPANY REGISTERED UNDER COMPANY ACT 1956 OF, 22/23 SHUBH BUILDING, SAGAR MANTHAN INDUSTRIAL COMPLEX, BHOIDAPADA, VASAI (E), THANE - 401208, MAHARASHTRA, INDIA		
DATE OF REGISTRATION	08/08/2014	
TITLE	ROTARY REGULATOR	
PRIORITY NA		
DESIGN NUMBER	264297	
CLASS	15-03	
1)HAR INTERNATIONAL, KHANNA ROAD, VILL. OTALAN, SAMRALA, DISTT. LUDHIANA-141114 (PUNJAB) INDIA AN INDIAN PROPRIETORSHIP FIRM WHOSE PROPRIETOR IS:- HARJIT SINGH BEING INDIAN NATIONALS OF THE ABOVE ADDRESS		
DATE OF REGISTRATION	28/07/2014	
TITLE	DRILLING EQUIPMENT FOR SEED & FERTILIZER	
PRIORITY NA		
DESIGN NUMBER	263277	
CLASS	12-16	
1)R. N. GUPTA & COMPANY LIMITED, (AN INDIAN COMPANY INCORPORATED UNDER THE COMPANIES ACT, 1956), HAVING ITS OFFICE AT UNIT-II, GT ROAD, TEHSIL PAYAL, DORAHA-141421		
DATE OF REGISTRATION	11/06/2014	
TITLE	JIB HEAD SNATCH BLOCK ASSEMBLY OF CRANE	
PRIORITY NA		

DESIGN NUMBER	259977
CLASS	12-16
1)TATA MOTORS LIMITED, AN INDIAN COMPANY OF BOMBAY HOUSE, 24 HOMI MODY STREET, HUTATMA CHOWK, MUMBAI 400 001, MAHARASHTRA, INDIA	
DATE OF REGISTRATION	31/01/2014
TITLE	INSTRUMENT CLUSTER OF A VEHICLE
PRIORITY NA	





DESIGN NUMBER	264049
CLASS	12-11
1)HERO CYCLES LIMITED, HERO NAGAR G. T. ROAD, LUDHIANA-141003 (PUNJAB), INDIA, (AN INDIAN COMPANY DULY INCORPORATED UNDER THE PROVISIONS OF INDIAN COMPANIES ACT, 1956)	
DATE OF REGISTRATION	15/07/2014
TITLE	BICYCLE
PRIORITY NA	

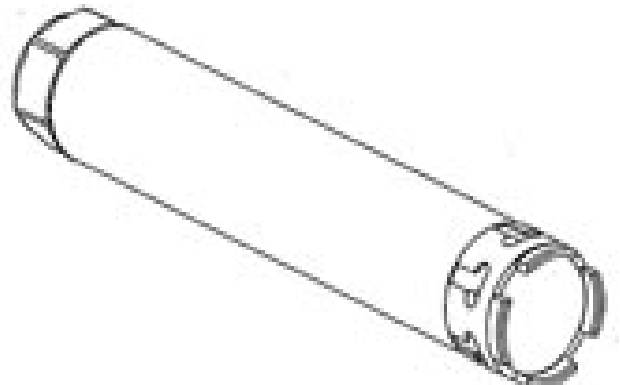

DESIGN NUMBER	260252	
CLASS	08-01	
1)HILTI AKTIENGESELLSCHAFT, FELDKIRCHERSTRASSE 100, FL-9494 SCHAAN, LIECHTENSTEIN, NATIONALITY: LIECHTENSTEIN		
DATE OF REGISTRATION	10/02/2014	
TITLE	CORE BIT USED IN DRILLING	
PRIORITY		
PRIORITY NUMBER	DATE	COUNTRY
756199601	09/08/2013	WIPO

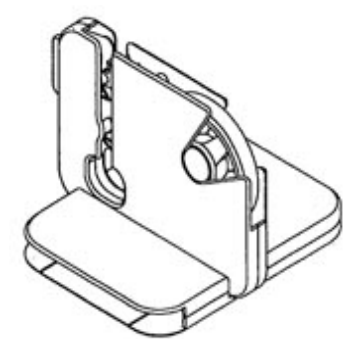



DESIGN NUMBER	262874		
CLASS	15-99		
1)HYGIENIC WASTE SOLUTIONS LTD, THE OLD GRAIN STORE, ADSDEAN FARM, FUNTINGTON, CHICHESTER, PO18 9DN, UNITED KINGDOM, NATIONALITY: UNITED KINGDOM			
DATE OF REGISTRATION	23/05/2014		
TITLE	BAG SEALER DEVICE		
PRIORITY			
PRIORITY NUMBER	DATE	COUNTRY	
4033031	26/11/2013	U.K.	
DESIGN NUMBER	262948		
CLASS	03-01		
1)SHIVKUMAR SANGAYYA BHIKSHAVATIMATH, 'PIYUSH' BUNGALOW NO. 15, ANITA RESIDENCY, KATRAJ-KONDHVA BYPASS ROAD, KATRAJ-411046, PUNE MAHARASHTRA INDIA, INDIAN NATIONAL			
DATE OF REGISTRATION	28/05/2014		
TITLE	BOX		
PRIORITY NA			
DESIGN NUMBER	264609		
CLASS	13-03		
1)GOLD MEDAL ELECTRICALS PVT. LTD. A COMPANY REGISTERED UNDER COMPANY ACT 1956 OF, 22/23 SHUBH BUILDING, SAGAR MANTHAN INDUSTRIAL COMPLEX, BHOIDAPADA, VASAI (E), THANE - 401208, MAHARASHTRA, INDIA			
DATE OF REGISTRATION	08/08/2014		
TITLE	ROTARY REGULATOR		
PRIORITY NA			

DESIGN NUMBER	264389		
CLASS	19-06		
1)PREMEC S.A., A CORPORATION ORGANIZED AND EXISTING UNDER THE LAWS OF SWITZERLAND, OF VIA INDUSTRIA, 6814 CADEMPINO, SWITZERLAND			
DATE OF REGISTRATION	31/07/2014		
TITLE	PEN		
PRIORITY			
PRIORITY NUMBER	DATE	COUNTRY	
140463	05/02/2014	SWITZERLAND	
DESIGN NUMBER	262375		
CLASS	09-01		
1)THE COCA-COLA COMPANY, A CORPORATION ORGANIZED AND EXISTING UNDER THE LAWS OF THE STATE OF DELAWARE HAVING AN OFFICE AT ONE COCA-COLA PLAZA NW, ATLANTA, GEORGIA 30313, USA			
DATE OF REGISTRATION	06/05/2014		
TITLE	BOTTLE		
PRIORITY			
PRIORITY NUMBER	DATE	COUNTRY	
2013-025907	06/11/2013	JAPAN	
DESIGN NUMBER	266633		
CLASS	28-03		
1)UDIT AGARWAL, AN INDIAN CITIZEN, C/O GANGA SANITARY STORE, STATION ROAD, MORADABAD-244001, UP, INDIA			
DATE OF REGISTRATION	10/10/2014		
TITLE	DISPENSER		
PRIORITY NA			

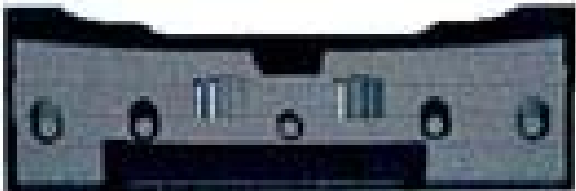

DESIGN NUMBER	260002		
CLASS	12-16		
1)TATA MOTORS LIMITED, AN INDIAN COMPANY OF BOMBAY HOUSE, 24 HOMI MODY STREET, HUTATMA CHOWK, MUMBAI 400001, MAHARASHTRA, INDIA			
DATE OF REGISTRATION	31/01/2014		
TITLE	PARCEL TRAY OF A VEHICLE		
PRIORITY NA			
DESIGN NUMBER	263972		
CLASS	12-16		
1)SCANIA CV AB, A SWEDISH COMPANY OF SE-151 87, SÖDERTÄLJE, SWEDEN			
DATE OF REGISTRATION	11/07/2014		
TITLE	AIR DEFLECTOR DOOR FOR AUTOMOBILES		
PRIORITY			
PRIORITY NUMBER	DATE	COUNTRY	
2014/0026	23/01/2014	SWEDEN	
DESIGN NUMBER	264611		
CLASS	13-03		
1)GOLD MEDAL ELECTRICALS PVT. LTD. A COMPANY REGISTERED UNDER COMPANY ACT 1956 OF, 22/23 SHUBH BUILDING, SAGAR MANTHAN INDUSTRIAL COMPLEX, BHODAPADA, VASAI (E), THANE - 401208, MAHARASHTRA, INDIA			
DATE OF REGISTRATION	08/08/2014		
TITLE	SWITCH		
PRIORITY NA			



DESIGN NUMBER	260003	
CLASS	12-16	
1)TATA MOTORS LIMITED, AN INDIAN COMPANY OF BOMBAY HOUSE, 24 HOMI MODY STREET, HUTATMA CHOWK, MUMBAI 400001, MAHARASHTRA, INDIA		
DATE OF REGISTRATION	31/01/2014	
TITLE	TAILGATE SCUFF PLATE OF A VEHICLE	
PRIORITY NA		

DESIGN NUMBER	263526	
CLASS	09-02	
1)MOLD-TEK PACKAGING LIMITED, PLOT NO. 700, ROAD NO. 36, JUBILEE HILLS, HYDERABAD-500036, STATE: TELANGANA, INDIA, AN INDIAN COMPANY		
DATE OF REGISTRATION	19/06/2014	
TITLE	CONTAINER	
PRIORITY NA		

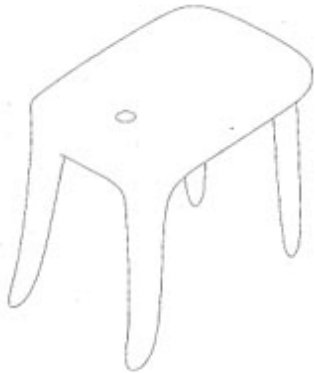
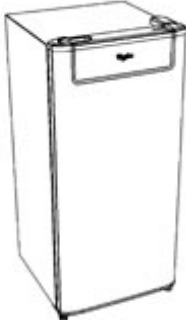
DESIGN NUMBER	260285	
CLASS	09-05	
1)1. SHRUTI GUPTA, INDIAN NATIONAL, B/11, HIMGIRI RESIDENCY, 585, MARKETYARD, PUNE-411037, M.S., INDIA, 2. PARIN SANGHVI, INDIAN NATIONAL, 402, SAPREM FLATS, NEAR MEDI SURGE HOSPITAL, MITHAKALI 6 ROADS, NAVRANGPURA, AHMEDABAD-380006, GUJARAT, INDIA & 3. MOHIT SINGHVI, INDIAN NATIONAL, 6-A-1, RANGBARI ROAD, NEAR POWER HOUSE, KOTA 324007, RAJASTHAN, INDIA		
DATE OF REGISTRATION	12/02/2014	
TITLE	BAG	
PRIORITY NA		

DESIGN NUMBER	265084	
CLASS	08-06	
1)KAPILBHAI BALVANTRAI VYAS AND JIGNESHBHAI CHHAGANBHAI GOHEL BOTH INDIAN NATIONAL PARTNER OF RATNAPRABHA HARDWARE AN INDIAN PARTNERSHIP FIRM HAVING ITS PRINCIPAL PLACE OF BUSINESS AT ADDRESS:- 6, PARSANA SOCIETY, 50 FEET ROAD, KOTHARIYA MAIN ROAD, RAJKOT-2. GUJARAT-INDIA		
DATE OF REGISTRATION	25/08/2014	
TITLE	HANDLE	
PRIORITY NA		
DESIGN NUMBER	263919	
CLASS	23-01	
1)DAYAL CHAND TRADING AS M/S. SIGMA REFRIGERATION WORKS, 3745, SHOP NO. 1 & 7, KUCHA PARMANAND, NETAJI SUBHASH MARG, DARYA GANJ, NEW DELHI-110002, INDIA (A SOLE PROPRIETORSHIP FIRM)		
DATE OF REGISTRATION	08/07/2014	
TITLE	VALVE	
PRIORITY NA		
DESIGN NUMBER	264612	
CLASS	13-03	
1)GOLD MEDAL ELECTRICALS PVT. LTD. A COMPANY REGISTERED UNDER COMPANY ACT 1956 OF, 22/23 SHUBH BUILDING, SAGAR MANTHAN INDUSTRIAL COMPLEX, BHOIDAPADA, VASAI (E), THANE - 401208, MAHARASHTRA, INDIA		
DATE OF REGISTRATION	08/08/2014	
TITLE	SWITCH	
PRIORITY NA		

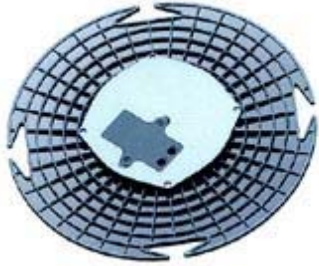
DESIGN NUMBER	262377		
CLASS	06-03		
1)A3NP INDÚSTRIA E COMÉRCIO DE MÓVEIS S/A, A BRAZILIAN COMPANY OF RUA IGUATEMI, 192, CONJUNTO 174 B, ITAIM BIBI, SÃO PAULO-SP, ZIP CODE: 01451-010 BRAZIL			
DATE OF REGISTRATION	06/05/2014		
TITLE	TABLE		
PRIORITY			
PRIORITY NUMBER	DATE	COUNTRY	
BR302013005703-08	07/11/2013	BRAZIL	
DESIGN NUMBER	265353		
CLASS	15-07		
1)WHIRLPOOL OF INDIA LIMITED, AN INDIAN COMPANY HAVING ITS CORPORATE OFFICE AT 'WHIRLPOOL HOUSE', PLOT NO. 40, SECTOR-44, GURGAON-122002, HARYANA, INDIA			
DATE OF REGISTRATION	02/09/2014		
TITLE	REFRIGERATOR		
PRIORITY NA			
DESIGN NUMBER	262616		
CLASS	12-11		
1)AMAN INTERNATIONAL, PLOT NO. 2639, URBAN ESTATE, DUGRI ROAD, PHASE-I, FOCAL POINT, LUDHIANA-141002 (PUNJAB) INDIA. AN INDIAN PARTNERSHIP FIRM WHOSE PARTNERS ARE:- AMIT BANSAL AND AMAN BANSAL BEING INDIAN NATIONALS OF THE ABOVE ADDRESS			
DATE OF REGISTRATION	15/05/2014		
TITLE	PADDLE FOR BICYCLE		
PRIORITY NA			

DESIGN NUMBER	263045		
CLASS	07-99		
1)MA DESIGN INDIA PRIVATE LIMITED, A COMPANY INCORPORATED IN INDIA HAVING ITS PRINCIPAL PLACE OF BUSINESS AT A-41, SECTOR-80, PHASE-II, NOIDA-201305, U.P. INDIA			
DATE OF REGISTRATION	02/06/2014		
TITLE	TRAY		
PRIORITY NA			
DESIGN NUMBER	263195		
CLASS	21-02		
1)B. G. SPORTS INTERNATIONAL LTD, WALTON STREET WORKS, WALTON STREET, COLNE, LANCASHIRE, BB8 0EA, UNITED KINGDOM, A BRITISH COMPANY			
DATE OF REGISTRATION	06/06/2014		
TITLE	SPORTS TARGET		
PRIORITY			
PRIORITY NUMBER	DATE	COUNTRY	
002367938-0001	11/12/2013	OHIM	
DESIGN NUMBER	264613		
CLASS	13-03		
1)GOLD MEDAL ELECTRICALS PVT. LTD. A COMPANY REGISTERED UNDER COMPANY ACT 1956 OF, 22/23 SHUBH BUILDING, SAGAR MANTHAN INDUSTRIAL COMPLEX, BHOIDAPADA, VASAI (E), THANE - 401208, MAHARASHTRA, INDIA			
DATE OF REGISTRATION	08/08/2014		
TITLE	SWITCH WITH SOCKET		
PRIORITY NA			

DESIGN NUMBER	264510	
CLASS	08-08	
1)GAURAV GANDHI WHOSE ADDRESS IS SHAHPARA, ALIGARH 202001, UTTAR PRADESH, INDIA, A CITIZEN OF INDIA		
DATE OF REGISTRATION	06/08/2014	
TITLE	DOOR HANDLE MOUNTING PLATE	
PRIORITY NA		

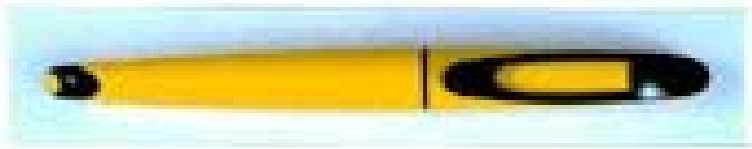

DESIGN NUMBER	262471	
CLASS	19-06	
1)FLAIR PENS LIMITED, AN INDIAN PARTNERSHIP FIRM OF 63, B/C, GOVT. INDUSTRIAL ESTATE, CHARKOP, KANDIVALI (W), MUMBAI - 400067, [MAHARASHTRA] INDIA		
DATE OF REGISTRATION	09/05/2014	
TITLE	PEN	
PRIORITY NA		



DESIGN NUMBER	263047	
CLASS	07-01	
1)MA DESIGN INDIA PRIVATE LIMITED, A COMPANY INCORPORATED IN INDIA HAVING ITS PRINCIPAL PLACE OF BUSINESS AT A-41, SECTOR-80, PHASE-II, NOIDA-201305, U.P. INDIA		
DATE OF REGISTRATION	02/06/2014	
TITLE	DISH	
PRIORITY NA		



DESIGN NUMBER	260019		
CLASS	26-06		
1)TATA MOTORS LIMITED, AN INDIAN COMPANY OF BOMBAY HOUSE, 24 HOMI MODY STREET, HUTATMA CHOWK, MUMBAI 400 001, MAHARASHTRA, INDIA			
DATE OF REGISTRATION	31/01/2014		
TITLE	HEAD LAMP OF A VEHICLE		
PRIORITY NA			
DESIGN NUMBER	259538		
CLASS	24-02		
1)YSP CO. LTD, A TAIWAN BASED ENTITY INCORPORATED UNDER THE TAIWAN LAW, HAVING ITS PLACE OF BUSINESS AT 3F., NO 54, GUANGHUA 2ND ST., NORTH DIST., HSINCHU CITY 300, TAIWAN, R.O.C.			
DATE OF REGISTRATION	20/01/2014		
TITLE	BLOOD LANCET USED FOR DIAGNOSTIC PURPOSES		
PRIORITY			
PRIORITY NUMBER	DATE	COUNTRY	
102306698	11/10/2013	CHINA	
DESIGN NUMBER	263923		
CLASS	13-02		
1)KDM TELECOM SOLUTIONS PVT. LTD., (AN INDIAN PRIVATE LIMITED COMPANY REGISTERED UNDER THE INDIAN COMPANIES ACT, 1956), HAVING OFFICE AT 411/4TH FLOOR, ADITYA ARCADE, LAMINGTON ROAD, TOPIWALA LANE, GRANT ROAD (EAST), MUMBAI-400008. MAHARASHTRA, INDIA			
DATE OF REGISTRATION	08/07/2014		
TITLE	MOBILE CHARGER		
PRIORITY NA			

DESIGN NUMBER	264614	
CLASS	13-03	
1)GOLD MEDAL ELECTRICALS PVT. LTD. A COMPANY REGISTERED UNDER COMPANY ACT 1956 OF, 22/23 SHUBH BUILDING, SAGAR MANTHAN INDUSTRIAL COMPLEX, BHOIDAPADA, VASAI (E), THANE - 401208, MAHARASHTRA, INDIA		
DATE OF REGISTRATION	08/08/2014	
TITLE	COVER PLATE	
PRIORITY NA		
DESIGN NUMBER	261105	
CLASS	06-11	
1)SAHIL PLASTIC PVT. LTD., A COMPANY INCORPORATED UNDER THE COMPANIES ACT, 1956 WHOSE ADDRESS IS NO. 5 MIRZA STREET, OPPOSITE: ABDULREHMAN STREET, MUMBAI 400003 IN THE STATE OF MAHARASHTRA WITHIN THE UNION OF INDIA, WHO ARE INDIAN BY NATIONALITY		
DATE OF REGISTRATION	19/03/2014	
TITLE	MAT	
PRIORITY NA		
DESIGN NUMBER	264399	
CLASS	09-01	
1)UNILEVER PLC, A COMPANY REGISTERED IN ENGLAND AND WALES UNDER COMPANY NO. 41424 OF UNILEVER HOUSE, 100 VICTORIA EMBANKMENT, LONDON, EC4Y 0DY, UNITED KINGDOM		
DATE OF REGISTRATION	31/07/2014	
TITLE	BOTTLE	
PRIORITY		
PRIORITY NUMBER	DATE	COUNTRY
002407635-0001	19/02/2014	OHIM



DESIGN NUMBER	262405		
CLASS	08-03		
1)FAM OF NEERVELD, 2, KONTICH, B-2550, BELGIUM			
DATE OF REGISTRATION	07/05/2014		
TITLE	CUTTING TOOL		
PRIORITY			
PRIORITY NUMBER	DATE	COUNTRY	
1389100-0004	07/11/2013	OHIM	
DESIGN NUMBER	265166		
CLASS	09-01		
1)B. L. AGRO OILS LIMITED B-31, ROAD NO.2, PARSAKHERA INDUSTRIAL AREA, BAREILLY 243502, UTTAR PRADESH, INDIA, A LIMITED COMPANY INCORPORATED UNDER THE INDIAN COMPANIES ACT,1956			
DATE OF REGISTRATION	26/08/2014		
TITLE	BOTTLE		
PRIORITY NA			
DESIGN NUMBER	262475		
CLASS	19-06		
1)FLAIR PENS AND STATIONERY INDUSTRIES, AN INDIAN PARTNERSHIP FIRM OF 63, B/C, GOVT. INDUSTRIAL ESTATE, CHARKOP, KANDIVALI (W), MUMBAI - 400067, [MAHARASHTRA], INDIA; WHOSE PARTNERS ARE KHUBILAL J. RATHOD, RAJESH K. RATHOD, VIMALCHAND J. RATHOD, MOHIT K. RATHOD AND SUMIT V. RATHOD; ALL INDIANS OF THE ABOVE ADDRESS			
DATE OF REGISTRATION	09/05/2014		
TITLE	PEN		
PRIORITY NA			

DESIGN NUMBER	263115	
CLASS	09-03	
1)RAJNI VALLBBHAI PATEL, AN INDIAN NATIONAL, PROPRIETOR OF RIDDHI LUBES OF 61 DIAMOND NAGAR SOCIETY, B/H, PATEL SAMAJ WADI SARDAR CHOCK, SURAT 6, GUJARAT, INDIA		
DATE OF REGISTRATION	04/06/2014	
TITLE	CONTAINER	
PRIORITY NA		
DESIGN NUMBER	266374	
CLASS	12-09	
1)MAHINDRA & MAHINDRA LIMITED, A COMPANY INCORPORATED UNDER THE COMPANIES ACT, 1913 WHOSE ADDRESS IS GATEWAY BUILDING, APOLLO BUNDER, MUMBAI 400001, MAHARASHTRA, INDIA		
DATE OF REGISTRATION	30/09/2014	
TITLE	TRACTOR BUMPER	
PRIORITY NA		
DESIGN NUMBER	262741	
CLASS	14-02	
1)CHANDRA MAURYA PTE LTD. A COMPANY REGISTERED UNDER THE COMPANIES ACT 1956 HAVING ITS REGISTERED OFFICE AT, 1 NORTH BRIDGE ROAD, #19-04-05, HIGH STREET CENTER, SINGAPORE, 179094, NATIONALITY: SINGAPORE		
DATE OF REGISTRATION	20/05/2014	
TITLE	TABLET COMPUTER FOR CHILDREN	
PRIORITY NA		

DESIGN NUMBER	263792		
CLASS	07-01		
1)S. N. PLAST, NATIONALITY: AN INDIAN, ADDRESS: 41, KRISHNA ESTATE, B/H. B.O.C. GASSES, OPP. GOPINATH ESTATE, NR. SONI NI CHAWL, RAKHIAL, AHMEDABAD, GUJARAT-380023			
DATE OF REGISTRATION	01/07/2014		
TITLE	BOWL		
PRIORITY NA			
DESIGN NUMBER	264401		
CLASS	09-07		
1)UNILEVER PLC, A COMPANY REGISTERED IN ENGLAND AND WALES UNDER COMPANY NO. 41424 OF UNILEVER HOUSE, 100 VICTORIA EMBANKMENT, LONDON, EC4Y 0DY, UNITED KINGDOM			
DATE OF REGISTRATION	31/07/2014		
TITLE	CAP		
PRIORITY			
PRIORITY NUMBER	DATE	COUNTRY	
002407676-0001	19/02/2014	OHIM	
ESIGN NUMBER	263288		
CLASS	15-05		
1)KONINKLIJKE PHILIPS N.V., A COMPANY ORGANIZED AND EXISTING UNDER THE LAWS OF THE KINGDOM OF THE NETHERLANDS, RESIDING AT EINDHOVEN, WHOSE POST-OFFICE ADDRESS IS HIGH TECH CAMPUS 5, 5656 AE EINDHOVEN, THE NETHERLANDS			
DATE OF REGISTRATION	12/06/2014		
TITLE	VACUUM CLEANER		
PRIORITY			
PRIORITY NUMBER	DATE	COUNTRY	
002380527-0002	06/01/2014	OHIM	

DESIGN NUMBER	262407		
CLASS	08-03		
1)FAM OF NEERVELD, 2, KONTICH, B-2550, BELGIUM			
DATE OF REGISTRATION	07/05/2014		
TITLE	CUTTING TOOL		
PRIORITY			
PRIORITY NUMBER	DATE	COUNTRY	
1389092-0004	07/11/2013	OHIM	
DESIGN NUMBER	262479		
CLASS	19-06		
1)FLAIR WRITING INSTRUMENTS, AN INDIAN PARTNERSHIP FIRM OF 63, B/C, GOVT. INDUSTRIAL ESTATE, CHARKOP, KANDIVALI (W), MUMBAI-400067, [MAHARASHTRA], INDIA; WHOSE PARTNERS ARE KHUBILAL J. RATHOD, MANJULA V. RATHOD AND MOHIT RATHOD; ALL INDIANS OF THE ABOVE ADDRESS			
DATE OF REGISTRATION	09/05/2014		
TITLE	PEN		
PRIORITY NA			
DESIGN NUMBER	262996		
CLASS	04-02		
1)COLGATE-PALMOLIVE COMPANY, A DELAWARE CORPORATION, 300 PARK AVENUE, NEW YORK, NEW YORK 10022, UNITED STATES OF AMERICA			
DATE OF REGISTRATION	30/05/2014		
TITLE	TOOTHBRUSH		
PRIORITY			
PRIORITY NUMBER	DATE	COUNTRY	
29/476,688	16/12/2013	U.S.A.	

DESIGN NUMBER	263058	
CLASS	15-03	
1)MILLTEC MACHINERY PRIVATE LIMITED OF NO. 51-A, 1ST PHASE KIADB INDL AREA, BOMMASANDRA, BANGALORE-560099, STATE OF KARNATAKA, INDIA, AN INDIAN COMPANY		
DATE OF REGISTRATION	02/06/2014	
TITLE	HUSK SEPARATOR	
PRIORITY NA		
DESIGN NUMBER	261150	
CLASS	09-01	
1)MARICO CONSUMER CARE LIMITED, AN INDIAN COMPANY, OF 7TH FLOOR, GRANDE PALLADIUM, 175 C.S.T. ROAD KALINA, SANTACRUZ (E), MUMBAI 400098 (INDIA)		
DATE OF REGISTRATION	20/03/2014	
TITLE	JAR	
PRIORITY NA		
DESIGN NUMBER	264281	
CLASS	31-00	
1)MR. MAHENDRA JAIN ADDRESS SARASWATI HOUSE, 24/203-204, 2ND UNNAT NAGAR, GOREGAON (WEST), MUMBAI-400104, INDIA; NATIONALITY-INDIAN		
DATE OF REGISTRATION	28/07/2014	
TITLE	MIXER GRINDER	
PRIORITY NA		

DESIGN NUMBER	262410	
CLASS	12-15	
1)METRO TYRES LIMITED, A COMPANY INCORPORATED UNDER THE INDIAN COMPANIES ACT, 1956 NATIONALITY: INDIAN COMPANY, C-49, SECTOR-62, NOIDA-201301, U.P.		
DATE OF REGISTRATION	07/05/2014	
TITLE	TYRE	
PRIORITY NA		

DESIGN NUMBER	265368	
CLASS	02-02	
1)RAMSON EXPORTS (INDIA), 808, STREET NO. 2, SHANKER LANE, GURU VIHAR, RAHON ROAD, LUDHIANA-141007 (PUNJAB), INDIA, AN INDIAN PROPRIETORSHIP FIRM WHOSE PARTNERS ARE:- ARJUN SOOD AND KARUNA SOOD BEING INDIAN NATIONALS OF THE ABOVE ADDRESS		
DATE OF REGISTRATION	02/09/2014	
TITLE	T-SHIRT	
PRIORITY NA		

DESIGN NUMBER	262481	
CLASS	19-06	
1)FLAIR WRITING INSTRUMENTS, AN INDIAN PARTNERSHIP FIRM OF 63, B/C, GOVT. INDUSTRIAL ESTATE, CHARKOP, KANDIVALI (W), MUMBAI-400067, [MAHARASHTRA], INDIA; WHOSE PARTNERS ARE KHUBILAL J. RATHOD, MANJULA V. RATHOD AND MOHIT RATHOD; ALL INDIANS OF THE ABOVE ADDRESS		
DATE OF REGISTRATION	09/05/2014	
TITLE	PEN	
PRIORITY NA		

DESIGN NUMBER	263061		
CLASS	21-01		
1)M/S RAJA INDUSTRIES (PARTNERSHIP FIRM) AT PALA ROAD, GOPAL PURI, ALIGARH (U.P.) INDIA, THROUGH ITS PARTNERS GIRRAJ KISHORE RATHI & KESHAV RATHI, BY NATIONALITY INDIAN OF ABOVE ADDRESS			
DATE OF REGISTRATION	02/06/2014		
TITLE	TOY PISTOL		
PRIORITY NA			
DESIGN NUMBER	262766		
CLASS	02-04		
1)SOLESTER FASHION PVT. LTD. OF THE ADDRESS SUITE NO. 1, INHWA BUSINESS CENTRE, IRIS TECH PARK, SOHNA ROAD, GURGAON-122018, INDIA			
DATE OF REGISTRATION	21/05/2014		
TITLE	FOOTWEAR		
PRIORITY NA			
DESIGN NUMBER	263391		
CLASS	10-05		
1)GENERAL ELECTRIC COMPANY HAVING ITS OFFICE AT 1 RIVER ROAD, SCHENECTADY, NEW YORK 12345, UNITED STATES OF AMERICA			
DATE OF REGISTRATION	16/06/2014		
TITLE	HANDSET BORESCOPE ASSEMBLY		
PRIORITY			
PRIORITY NUMBER	DATE	COUNTRY	
29/477539	23/12/2013	U.S.A.	



DESIGN NUMBER	266414	
CLASS	06-03	
1)GODREJ & BOYCE MFG. CO. LTD., AN INDIAN COMPANY INCORPORATED UNDER THE COMPANIES ACT, 1913, OF INTERIO DIVISION, PLANT 4, PIROJSHANAGAR, VIKHROLI (WEST), MUMBAI-400079, INDIA		
DATE OF REGISTRATION	07/10/2014	
TITLE	DINING TABLE	
PRIORITY NA		
DESIGN NUMBER	262483	
CLASS	19-06	
1)FLAIR WRITING INSTRUMENTS, AN INDIAN PARTNERSHIP FIRM OF 63, B/C, GOVT. INDUSTRIAL ESTATE, CHARKOP, KANDIVALI (W), MUMBAI-400067, [MAHARASHTRA], INDIA; WHOSE PARTNERS ARE KHUBILAL J. RATHOD, MANJULA V. RATHOD AND MOHIT RATHOD; ALL INDIANS OF THE ABOVE ADDRESS		
DATE OF REGISTRATION	09/05/2014	
TITLE	PEN	
PRIORITY NA		
DESIGN NUMBER	265171	
CLASS	12-16	
1)KLASSIC WHEELS PVT. LTD., A COMPANY INCORPORATED UNDER THE INDIAN COMPANIES ACT, AT E-7 & E-8 M.I.D.C., AHMEDABAD, MAHARASHTRA, INDIA		
DATE OF REGISTRATION	27/08/2014	
TITLE	WHEEL RIM FOR VEHICLES	
PRIORITY NA		

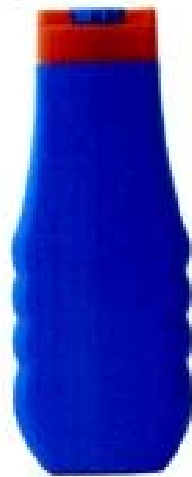

DESIGN NUMBER	263218		
CLASS	05-06		
1)(I) SATISHKUMAR DAYABHAI MANIYA, (II) SURESHBHAI VITHALBHAI GOTI, (III) RAMESH VIRJIBHAI KAKADIYA ALL INDIAN NATIONAL, PARTNERS OF M/S SHISH INDUSTRIES, AN INDIAN PARTNERSHIP FIRM, HAVING ADDRESS- 6/7, G.K. CHAMBERS, 1ST FLOOR, KOHINOOR ROAD, MINI BAZAR, VARACHHA, SURAT-395006, GUJARAT, INDIA			
DATE OF REGISTRATION	10/06/2014		
TITLE	CORRUGATED SHEET FOR PACKAGING		
PRIORITY NA			
DESIGN NUMBER	264240		
CLASS	12-16		
1)DEERE & COMPANY, A US CORPORATION OF ONE JOHN DEERE PLACE, MOLINE, ILLINOIS, 61265-8098 USA			
DATE OF REGISTRATION	25/07/2014		
TITLE	COWL UNIT FOR A VEHICLE		
PRIORITY NA			
DESIGN NUMBER	263643		
CLASS	08-08		
1)ATLAS COPCO AIRPOWER, NAAMLOZE VENNOOTSCHAP, OF BOOMSESTEENWEG 957, 2610 WILRIJK, BELGIUM, A BELGIAN COMPANY			
DATE OF REGISTRATION	24/06/2014		
TITLE	MOUNTING BRACKETS FOR TUBES		
PRIORITY			
PRIORITY NUMBER	DATE	COUNTRY	
002378604-001	30/12/2013	OHIM	

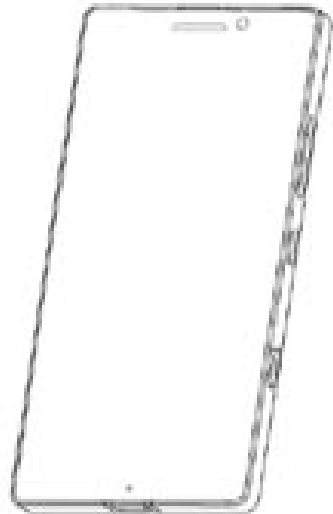

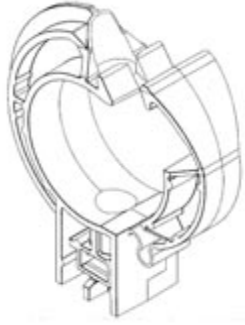
DESIGN NUMBER	264584	
CLASS	08-06	
1)(1) PRAVINBHAI BHIMJIBHAI RAIYANI (2) NARENDRABHAI NARSINHBHAI VADODARIYA (BOTH PARTNERS ARE ADULT AND INDIAN NATIONAL) PARTNERS OF SHUBHAM MANUFACTURE (INDIAN PARTNERSHIP FIRM) HAVING PLACE OF BUSINESS AT- 6, PARSANA SOCIETY, 50 FEET ROAD, NATHJI PAN, RAJKOT-360002-GUJARAT-(INDIA)		
DATE OF REGISTRATION	08/08/2014	
TITLE	HANDLE	
PRIORITY NA		

DESIGN NUMBER	265377	
CLASS	09-01	
1)WEENER EMPIRE PLASTICS LIMITED, AN INDIAN COMPANY OF 19A, MIRA CO-OPERATIVE INDUSTRIAL ESTATE, WESTERN EXPRESS HIGHWAY, MIRA ROAD (E) 401104, STATE OF MAHARASHTRA, INDIA		
DATE OF REGISTRATION	02/09/2014	
TITLE	BOTTLE WITH CAP	
PRIORITY NA		

DESIGN NUMBER	259633	
CLASS	14-03	
1)NOKIA CORPORATION, A FINNISH CORPORATION, OF THE ADDRESS KEILALAHDENTIE 4, ESPOO, FINLAND 02150		
DATE OF REGISTRATION	23/01/2014	
TITLE	HANDSET	
PRIORITY NA		

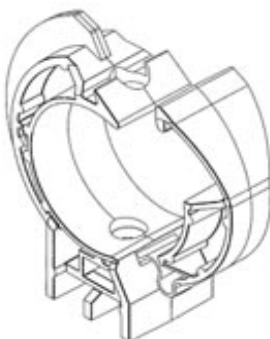
DESIGN NUMBER	263647		
CLASS	08-08		
1)ATLAS COPCO AIRPOWER, NAAMLOZE VENNOOTSCHAP, OF BOOMSESTEENWEG 957, 2610 WILRIJK, BELGIUM, A BELGIAN COMPANY			
DATE OF REGISTRATION	24/06/2014		
TITLE	MOUNTING BRACKETS FOR TUBES		
PRIORITY			
PRIORITY NUMBER	DATE	COUNTRY	
002378604-005	30/12/2013	OHIM	
DESIGN NUMBER	262779		
CLASS	09-01		
1)THE COCA-COLA COMPANY, A CORPORATION ORGANIZED AND EXISTING UNDER THE LAWS OF THE STATE OF DELAWARE HAVING AN OFFICE AT ONE COCA-COLA PLAZA NW, ATLANTA, GEORGIA 30313, USA			
DATE OF REGISTRATION	21/05/2014		
TITLE	BOTTLE		
PRIORITY			
PRIORITY NUMBER	DATE	COUNTRY	
2013-027380	22/11/2013	JAPAN	
DESIGN NUMBER	264462		
CLASS	06-08		
1)KUSHAL KARYASHALA PRIVATE LIMITED (A COMPANY INCORPORATED UNDER THE INDIAN COMPANIES ACT 1956), 1, RAJ NAGAR ENCLAVE, PITAM PURA, DELHI-110034 (INDIA)			
DATE OF REGISTRATION	05/08/2014		
TITLE	CLOTH HANGER		
PRIORITY NA			

DESIGN NUMBER	263353		
CLASS	10-01		
1)AJANTA PRIVATE LIMITED, AN INDIAN COMPANY OF ORPAT INDUSTRIAL ESTATE, RAJKOT-MORBI HIGHWAY, MORBI 363641, STATE OF GUJARAT, INDIA			
DATE OF REGISTRATION	13/06/2014		
TITLE	CLOCK		
PRIORITY NA			
DESIGN NUMBER	262486		
CLASS	19-06		
1)FLAIR WRITING INSTRUMENTS, AN INDIAN PARTNERSHIP FIRM OF 63, B/C, GOVT. INDUSTRIAL ESTATE, CHARKOP, KANDIVALI (W), MUMBAI- 400067, [MAHARASHTRA], INDIA; WHOSE PARTNERS ARE KHUBILAL J. RATHOD, MANJULA V. RATHOD AND MOHIT RATHOD; ALL INDIANS OF THE ABOVE ADDRESS			
DATE OF REGISTRATION	09/05/2014		
TITLE	PEN		
PRIORITY NA			
DESIGN NUMBER	263646		
CLASS	08-08		
1)ATLAS COPCO AIRPOWER, NAAMLOZE VENNOOTSCHAP, OF BOOMSESTEENWEG 957, 2610 WILRIJK, BELGIUM, A BELGIAN COMPANY			
DATE OF REGISTRATION	24/06/2014		
TITLE	MOUNTING BRACKETS FOR TUBES		
PRIORITY			
PRIORITY NUMBER	DATE	COUNTRY	
002378604 -004	30/12/2013	OHIM	

DESIGN NUMBER	262934		
CLASS	21-02		
1)MAGIC PRODUCTION GROUP S.A., A COMPANY OF LUXEMBOURG OF FINDEL BUSINESS CENTER, COMPLEXE B, RUE DE TRÈVES, L-2632 FINDEL, LUXEMBOURG			
DATE OF REGISTRATION	27/05/2014		
TITLE	TOY BALL		
PRIORITY			
PRIORITY NUMBER	DATE	COUNTRY	
DM/083478	30/04/2014	WIPO	
DESIGN NUMBER	264283		
CLASS	31-00		
1)MR. MAHENDRA JAIN ADDRESS SARASWATI HOUSE, 24/203-204, 2ND UNNAT NAGAR, GOREGAON (WEST), MUMBAI-400104, INDIA; NATIONALITY-INDIAN			
DATE OF REGISTRATION	28/07/2014		
TITLE	HAND BLENDER		
PRIORITY NA			
DESIGN NUMBER	264409		
CLASS	10-01		
1)(1) ROHIT PARIHAR S/O. SH. RAVINDRA SINGH PARIHAR (NATIONALITY-INDIAN), (2) CHANDER SINGH SOLANKI S/O. SH. SHYAM LAL SOLANKI (NATIONALITY-INDIAN), (3) SMT. ANITA PARIHAR W/O. SH. RAVINDRA SINGH PARIHAR (NATIONALITY-INDIAN), (4) SMT. NEENA SOLANKI W/O. SH. CHANDRA SINGH SOLANKI (NATIONALITY-INDIAN), (5) JITENDRA SOLANKI S/O. SH. SHYAM LAL SOLANKI PARTNERS OF M/S. SHREE ROOPSHREE ART EXPORTS (IT IS INDIAN PARTNERSHIP FIRM) AT-KHASRA NO. 01, SHRI RAM NAGAR, SANGARIA, NEAR BASANI, 2ND PHASE, JODHPUR (RAJASTHAN) NATIONALITY-INDIAN			
DATE OF REGISTRATION	31/07/2014		
TITLE	CLOCK		
PRIORITY NA			



DESIGN NUMBER	262484	
CLASS	19-06	
1)FLAIR WRITING INSTRUMENTS, AN INDIAN PARTNERSHIP FIRM OF 63, B/C, GOVT. INDUSTRIAL ESTATE, CHARKOP, KANDIVALI (W), MUMBAI-400067, [MAHARASHTRA], INDIA; WHOSE PARTNERS ARE KHUBILAL J. RATHOD, MANJULA V. RATHOD AND MOHIT RATHOD; ALL INDIANS OF THE ABOVE ADDRESS		
DATE OF REGISTRATION	09/05/2014	
TITLE	PEN	
PRIORITY NA		



DESIGN NUMBER	265172
CLASS	12-16
1)KLASSIC WHEELS PVT. LTD., A COMPANY INCORPORATED UNDER THE INDIAN COMPANIES ACT, AT E-7 & E-8 M.I.D.C., AHMEDABAD, MAHARASHTRA, INDIA	
DATE OF REGISTRATION	27/08/2014
TITLE	WHEEL RIM FOR VEHICLES
PRIORITY NA	

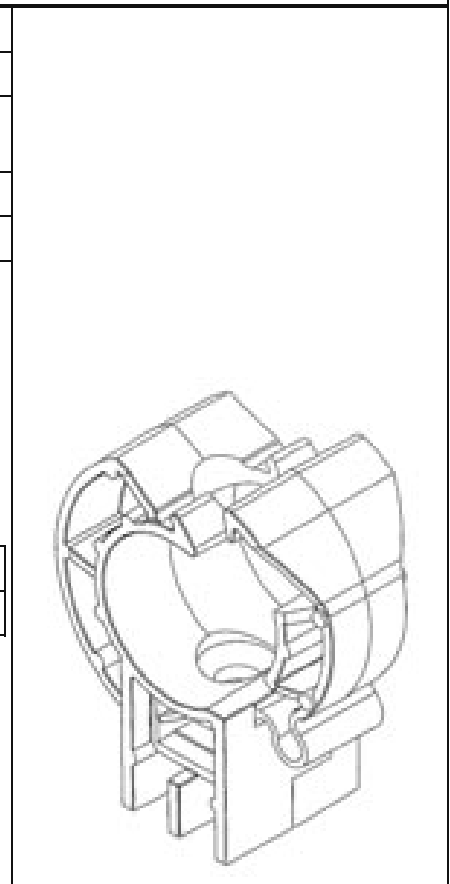

DESIGN NUMBER	263644	
CLASS	08-08	
1)ATLAS COPCO AIRPOWER, NAAMLOZE VENNOOTSCHAP, OF BOOMSESTEENWEG 957, 2610 WILRIJK, BELGIUM, A BELGIAN COMPANY		
DATE OF REGISTRATION	24/06/2014	
TITLE	MOUNTING BRACKETS FOR TUBES	
PRIORITY		
PRIORITY NUMBER	DATE	COUNTRY
002378604 -002	30/12/2013	OHIM



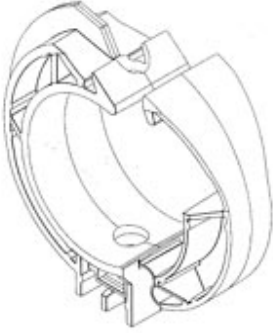

DESIGN NUMBER	262769	
CLASS	02-04	
1)SOLESTER FASHION PVT. LTD. OF THE ADDRESS SUITE NO. 1, INHWA BUSINESS CENTRE, IRIS TECH PARK, SOHNA ROAD, GURGAON-122018, INDIA		
DATE OF REGISTRATION	21/05/2014	
TITLE	FOOTWEAR	
PRIORITY NA		
DESIGN NUMBER	264594	
CLASS	13-03	
1)GOLD MEDAL ELECTRICALS PVT. LTD. A COMPANY REGISTERED UNDER COMPANY ACT 1956 OF, 22/23 SHUBH BUILDING, SAGAR MANTHAN INDUSTRIAL COMPLEX, BHOIDAPADA, VASAI (E), THANE - 401208, MAHARASHTRA, INDIA		
DATE OF REGISTRATION	08/08/2014	
TITLE	SWITCH BOARD FUSE & INDICATOR	
PRIORITY NA		
DESIGN NUMBER	263130	
CLASS	23-01	
1)KIMPLAS PIPING SYSTEMS LIMITED., AN INDIAN COMPANY INCORPORATED UNDER THE INDIAN COMPANIES ACT, 1956, HAVING REGISTERED OFFICE AT B-20, MIDC, AMBAD, NASHIK-422010, MAHARASHTRA, INDIA		
DATE OF REGISTRATION	05/06/2014	
TITLE	CLAMP FOR PIPE FITTINGS	
PRIORITY NA		

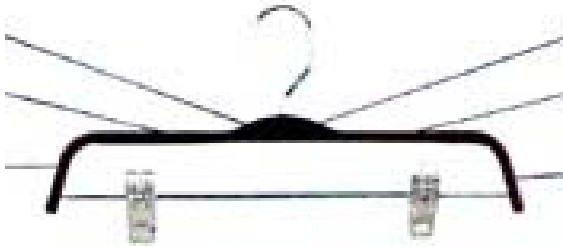

DESIGN NUMBER	259950		
CLASS	12-16		
1)TATA MOTORS LIMITED, AN INDIAN COMPANY OF BOMBAY HOUSE, 24 HOMI MODY STREET, HUTATMA CHOWK, MUMBAI 400 001, MAHARASHTRA, INDIA			
DATE OF REGISTRATION	31/01/2014		
TITLE	B PILLAR OF A VEHICLE		
PRIORITY NA			
DESIGN NUMBER	263648		
CLASS	08-08		
1)ATLAS COPCO AIRPOWER, NAAMLOZE VENNOOTSCHAP, OF BOOMSESTEENWEG 957, 2610 WILRIJK, BELGIUM, A BELGIAN COMPANY			
DATE OF REGISTRATION	24/06/2014		
TITLE	MOUNTING BRACKETS FOR TUBES		
PRIORITY			
PRIORITY NUMBER	DATE	COUNTRY	
002378604 - 006	30/12/2013	OHIM	
DESIGN NUMBER	260147		
CLASS	08-06		
1)DILIPBHAI BACHUBHAI HIRPARA (INDIAN NATIONALS) AND SOLE PROPRIETOR OF JANKI DIE-CAST (INDIAN PROPRIETORSHIP CONCERN) HAVING PLACE OF BUSINESS AT- PLOT NO. 834, AJI INDUSTRIAL AREA, NR; SITARAM WAY BRIDGE, OPP: MUNICIPAL WORKSHOP, BHAVNAGAR ROAD, RAJKOT-GUJARAT (INDIA)			
DATE OF REGISTRATION	06/02/2014		
TITLE	HANDLE		
PRIORITY NA			

DESIGN NUMBER	263764		
CLASS	23-02		
1)FIRST STEP PROJECTS, AN INDIAN PARTNERSHIP FIRM, OF D-151, SAKET, NEW DELHI-110017, INDIA			
DATE OF REGISTRATION	30/06/2014		
TITLE	DISPOSABLE FEMALE URINATION DEVICE		
PRIORITY NA			
DESIGN NUMBER	262780		
CLASS	12-16		
1)TOYOTA JIDOSHA KABUSHIKI KAISHA, A JAPANESE CO., OF 1, TOYOTA-CHO, TOYOTA-SHI, AICHI-KEN, 471-8571, JAPAN			
DATE OF REGISTRATION	21/05/2014		
TITLE	CATALYTIC CONVERTER		
PRIORITY			
PRIORITY NUMBER	DATE	COUNTRY	
JPD2014-000013	06/01/2014	JAPAN	
DESIGN NUMBER	264599		
CLASS	13-03		
1)GOLD MEDAL ELECTRICALS PVT. LTD. A COMPANY REGISTERED UNDER COMPANY ACT 1956 OF, 22/23 SHUBH BUILDING, SAGAR MANTHAN INDUSTRIAL COMPLEX, BHODAPADA, VASAI (E), THANE - 401208, MAHARASHTRA, INDIA			
DATE OF REGISTRATION	08/08/2014		
TITLE	SOCKET		
PRIORITY NA			

DESIGN NUMBER	264736	
CLASS	13-03	
1)GOLD MEDAL ELECTRICALS PVT. LTD. A COMPANY REGISTERED UNDER COMPANY ACT 1956 OF, 22/23 SHUBH BUILDING, SAGAR MANTHAN INDUSTRIAL COMPLEX, BHOIDAPADA, VASAI (E), THANE - 401208, MAHARASHTRA, INDIA		
DATE OF REGISTRATION	13/08/2014	
TITLE	MODULAR SWITCH PLATE	
PRIORITY NA		

DESIGN NUMBER	264461	
CLASS	06-08	
1)KUSHAL KARYASHALA PRIVATE LIMITED (A COMPANY INCORPORATED UNDER THE INDIAN COMPANIES ACT 1956), 1, RAJ NAGAR ENCLAVE, PITAM PURA, DELHI-110034 (INDIA)		
DATE OF REGISTRATION	05/08/2014	
TITLE	CLOTH HANGER	
PRIORITY NA		

DESIGN NUMBER	263352	
CLASS	10-01	
1)AJANTA PRIVATE LIMITED, AN INDIAN COMPANY OF ORPAT INDUSTRIAL ESTATE, RAJKOT-MORBI HIGHWAY, MORBI 363641, STATE OF GUJARAT, INDIA		
DATE OF REGISTRATION	13/06/2014	
TITLE	CLOCK	
PRIORITY NA		

DESIGN NUMBER	262568	
CLASS	11-02	
1)M/S. MARCO POLO S.R.L.; AN ITALIEN CORPORATION OF THE ADDRESS: VIA C., MARX, 8, 06011 CITTA DI CASTELLO (PG), ITALY		
DATE OF REGISTRATION	13/05/2014	
TITLE	TABLE CENTERPIECE	
PRIORITY NA		
DESIGN NUMBER	262658	
CLASS	12-16	
1)MUKESHBHAI L. GARDHARIYA AN INDIAN NATIONAL SOLE PROPRIETOR OF KASHYAP AUTO ELECTRONICS AN INDIAN PROPRIETORSHIP FIRM HAVING ITS PRINCIPAL PLACE OF BUSINESS AT A/106, RAMESHWAR ESTATE, VIRATNAGAR KENAL, OPP. KRISHNA SOCIETY, NEAR JAY CHEMICAL, ODHAV, AHMEDABAD-382 415, GUJARAT-INDIA		
DATE OF REGISTRATION	16/05/2014	
TITLE	SHOCK ABSORBING PAD FOR VEHICLES	
PRIORITY NA		
DESIGN NUMBER	259932	
CLASS	12-16	
1)TATA MOTORS LIMITED, AN INDIAN COMPANY OF BOMBAY HOUSE, 24 HOMI MODY STREET, HUTATMA CHOWK, MUMBAI 400001, MAHARASHTRA, INDIA		
DATE OF REGISTRATION	31/01/2014	
TITLE	TWEETER GRILLE OF A VEHICLE	
PRIORITY NA		

DESIGN NUMBER	263645		
CLASS	08-08		
1)ATLAS COPCO AIRPOWER, NAAMLOZE VENNOOTSCHAP, OF BOOMSESTEENWEG 957, 2610 WILRIJK, BELGIUM, A BELGIAN COMPANY			
DATE OF REGISTRATION	24/06/2014		
TITLE	MOUNTING BRACKETS FOR TUBES		
PRIORITY			
PRIORITY NUMBER	DATE	COUNTRY	
002378604 -003	30/12/2013	OHIM	
DESIGN NUMBER	263818		
CLASS	03-01		
1)FURLA S.P.A. VIA BELLARIA, 3-5, I-40068 SAN LAZZARO DI SAVENA (BOLOGNA) ITALY, NATIONALITY: ITALY			
DATE OF REGISTRATION	01/07/2014		
TITLE	HANDBAG		
PRIORITY			
PRIORITY NUMBER	DATE	COUNTRY	
002422733-0002	11/03/2014	OHIM	
DESIGN NUMBER	262933		
CLASS	21-02		
1)MAGIC PRODUCTION GROUP S.A., A COMPANY OF LUXEMBOURG OF FINDEL BUSINESS CENTER, COMPLEXE B, RUE DE TRÈVES, L-2632 FINDEL, LUXEMBOURG			
DATE OF REGISTRATION	27/05/2014		
TITLE	TOY BALL		
PRIORITY			
PRIORITY NUMBER	DATE	COUNTRY	
DM/083478	30/04/2014	WIPO	

DESIGN NUMBER	262586		
CLASS	13-03		
1)MR. PRASHANT M. DIXIT, ADULT, INDIAN NATIONAL HAVING ADDRESS FOR CORRESPONDENCE AT C/O VIJETA SWITCHGEAR PVT LTD, E-26, MIDC, KUPWAD BLOCK, SANGLI 416436, MAHARASHTRA, INDIA			
DATE OF REGISTRATION	15/05/2014		
TITLE	CABINET FOR ELECTRIC POWER CONTROL EQUIPMENT		
PRIORITY NA			
DESIGN NUMBER	262684		
CLASS	12-16		
1)SENTEC E&E CO., LTD., NATIONALITY: TAIWAN ADDRESS AT NO. 32, GONG 5TH RD., LONGTAN TOWNSHIP, TAOYUAN COUNTY 325, TAIWAN (R.O.C.)			
DATE OF REGISTRATION	19/05/2014		
TITLE	CARBON CANISTER FOR A MOTOR VEHICLE		
PRIORITY NA			
DESIGN NUMBER	263070		
CLASS	23-03		
1)KYOSHIN KOGYO CO., LTD, A CORPORATION INCORPORATED UNDER THE LAWS OF JAPAN, HAVING ITS OFFICE AT 20-7, EBIE 7-CHOME, FUKUSHIMA-KU, OSAKA-SHI, OSAKA, JAPAN			
DATE OF REGISTRATION	03/06/2014		
TITLE	HEAT EXCHANGER HOLDER		
PRIORITY			
PRIORITY NUMBER	DATE	COUNTRY	
30-2013-0061657	06/12/2013	REPUBLIC OF KOREA	

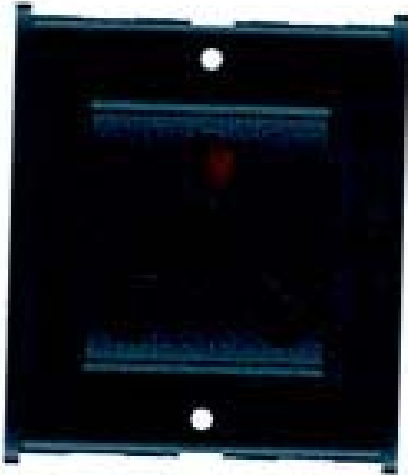

DESIGN NUMBER	259954	
CLASS	12-16	
1)TATA MOTORS LIMITED, AN INDIAN COMPANY OF BOMBAY HOUSE, 24 HOMI MODY STREET, HUTATMA CHOWK, MUMBAI 400001, MAHARASHTRA, INDIA		
DATE OF REGISTRATION	31/01/2014	
TITLE	CLUSTER BEZEL TOP OF A VEHICLE	
PRIORITY NA		

DESIGN NUMBER	264602	
CLASS	13-03	
1)GOLD MEDAL ELECTRICALS PVT. LTD. A COMPANY REGISTERED UNDER COMPANY ACT 1956 OF, 22/23 SHUBH BUILDING, SAGAR MANTHAN INDUSTRIAL COMPLEX, BHOIDAPADA, VASAI (E), THANE - 401208, MAHARASHTRA, INDIA		
DATE OF REGISTRATION	08/08/2014	
TITLE	SOCKET	
PRIORITY NA		

DESIGN NUMBER	264469	
CLASS	09-05	
1)ALKEM LABORATORIES LIMITED, HAVING OFFICE AT EXHIBITION ROAD, PATNA-800001		
DATE OF REGISTRATION	05/08/2014	
TITLE	BLISTER PACKAGE	
PRIORITY NA		

DESIGN NUMBER	262494		
CLASS	02-04		
1)RELAXO FOOTWEARS LTD., 316-319, ALLIED HOUSE, INDERLOK CHOWK, OLD ROHTAK ROAD, DELHI-110035, INDIA, AN INDIAN COMPANY REGISTERED UNDER INDIAN COMPANIES ACT, 1956, OF THE ABOVE ADDRESS			
DATE OF REGISTRATION	09/05/2014		
TITLE	SOLE OF SHOE		
PRIORITY NA			
DESIGN NUMBER	263131		
CLASS	23-01		
1)KIMPLAS PIPING SYSTEMS LIMITED., AN INDIAN COMPANY INCORPORATED UNDER THE INDIAN COMPANIES ACT, 1956, HAVING REGISTERED OFFICE AT B-20, MIDC, AMBAD, NASHIK-422 010, MAHARASHTRA, INDIA			
DATE OF REGISTRATION	05/06/2014		
TITLE	FILTER		
PRIORITY NA			
DESIGN NUMBER	265465		
CLASS	13-03		
1)YAZAKI CORPORATION, A JAPANESE CORPORATION OF 4-28, MITA 1-CHOME, MINATO-KU, TOKYO 108-0073, JAPAN			
DATE OF REGISTRATION	05/09/2014		
TITLE	ELECTRICAL CONNECTOR HOUSING		
PRIORITY			
PRIORITY NUMBER	DATE	COUNTRY	
2014-004809	07/03/2014	JAPAN	



DESIGN NUMBER	264600		
CLASS	13-03		
1)GOLD MEDAL ELECTRICALS PVT. LTD. A COMPANY REGISTERED UNDER COMPANY ACT 1956 OF, 22/23 SHUBH BUILDING, SAGAR MANTHAN INDUSTRIAL COMPLEX, BHOIDAPADA, VASAI (E), THANE - 401208, MAHARASHTRA, INDIA			
DATE OF REGISTRATION	08/08/2014		
TITLE	SOCKET		
PRIORITY NA			
DESIGN NUMBER	264743		
CLASS	13-03		
1)GOLD MEDAL ELECTRICALS PVT. LTD. A COMPANY REGISTERED UNDER COMPANY ACT 1956 OF, 22/23 SHUBH BUILDING, SAGAR MANTHAN INDUSTRIAL COMPLEX, BHOIDAPADA, VASAI (E), THANE - 401208, MAHARASHTRA, INDIA			
DATE OF REGISTRATION	13/08/2014		
TITLE	MODULAR SWITCH PLATE		
PRIORITY NA			
DESIGN NUMBER	262406		
CLASS	08-03		
1)FAM OF NEERVELD, 2, KONTICH, B-2550, BELGIUM			
DATE OF REGISTRATION	07/05/2014		
TITLE	CUTTING TOOL		
PRIORITY			
PRIORITY NUMBER	DATE	COUNTRY	
1389092-0002	07/11/2013	OHIM	

DESIGN NUMBER	262478		
CLASS	19-06		
1)FLAIR WRITING INSTRUMENTS, AN INDIAN PARTNERSHIP FIRM OF 63, B/C, GOVT. INDUSTRIAL ESTATE, CHARKOP, KANDIVALI (W), MUMBAI-400067, [MAHARASHTRA], INDIA; WHOSE PARTNERS ARE KHUBILAL J. RATHOD, MANJULA V. RATHOD AND MOHIT RATHOD; ALL INDIANS OF THE ABOVE ADDRESS			
DATE OF REGISTRATION	09/05/2014		
TITLE	PEN		
PRIORITY NA			
DESIGN NUMBER	266703		
CLASS	06-03		
1)GODREJ & BOYCE MFG. CO. LTD., AN INDIAN COMPANY INCORPORATED UNDER THE COMPANIES ACT 1913, OF INTERIO DIVISION, PLANT 4, PIROJSHANAGAR, VIKHROLI (WEST), MUMBAI-400079, INDIA			
DATE OF REGISTRATION	14/10/2014		
TITLE	DINING TABLE		
PRIORITY NA			
DESIGN NUMBER	260136		
CLASS	06-13		
1)PETER JASON WILLS, 28 COPEs CRESCENT, WOLVERHAMPTON, WEST MIDLANDS, WV10 0SL, UNITED KINGDOM, NATIONALITY: BRITISH			
DATE OF REGISTRATION	05/02/2014		
TITLE	DUVET COVER		
PRIORITY			
PRIORITY NUMBER	DATE	COUNTRY	
1379812-0002	06/08/2013	OHIM	

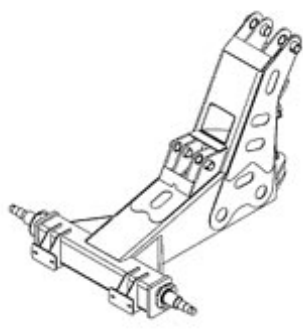
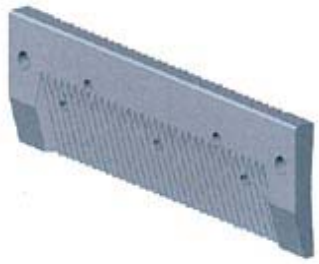

DESIGN NUMBER	261903	
CLASS	08-06	
1)(1) RUPESHBHAI MANSUKHBHAI MANSARA (2) JAYESHBHAI GOBARBHAI SHEKHALIYA (3) CHETANBHAI LAVJIBHAI SINGHALA (ALL THE PARTNERS ARE ADULT & INDIAN NATIONAL) PARTNERS OF JAY SOMNATH METAL (INDIAN PARTNERSHIP FIRM) HAVING PLACE OF BUSINESS AT: 3, MARUTI INDUSTRIAL AREA, KOTHARIA RING ROAD, B/H. MURLIDHAR WAYBRIDGE, N.H. 8B, RAJKOT-360003-GUJARAT-(INDIA)		
DATE OF REGISTRATION	22/04/2014	
TITLE	HANDLE	
PRIORITY NA		

DESIGN NUMBER	264263	
CLASS	08-06	
1)HARSHADBHAI KARSANBHAI AJANI (ADULT & INDIAN NATIONAL) SOLE PROPRIETOR OF PAL ENTERPRISE (INDIAN PROPRIETORSHIP CONCERN) HAVING PLACE OF BUSINESS AT: 6, PARSANA SOCIETY, 50 FEET ROAD, KOTHARIA ROAD, RAJKOT-GUJARAT- (INDIA)		
DATE OF REGISTRATION	28/07/2014	
TITLE	HANDLE	
PRIORITY NA		

DESIGN NUMBER	264330	
CLASS	26-05	
1)GE INDIA INDUSTRIAL PVT LTD, PLOT NO. 42/1 & 45/14, ELECTRONIC CITY PHASE II, BANGALORE-560100, NATIONALITY-INDIAN		
DATE OF REGISTRATION	28/07/2014	
TITLE	LIGHTING FIXTURE	
PRIORITY NA		

DESIGN NUMBER	263439		
CLASS	12-16		
1)R. N. GUPTA & COMPANY LIMITED, (AN INDIAN COMPANY INCORPORATED UNDER THE COMPANIES ACT, 1956), HAVING ITS OFFICE AT UNIT-II, GT ROAD, TEHSIL PAYAL, DORAHA-141421			
DATE OF REGISTRATION	17/06/2014		
TITLE	FRONT FRAME OF CRANE		
PRIORITY NA			
DESIGN NUMBER	262404		
CLASS	08-03		
1)FAM OF NEERVELD, 2, KONTICH, B-2550, BELGIUM			
DATE OF REGISTRATION	07/05/2014		
TITLE	CUTTING TOOL		
PRIORITY			
PRIORITY NUMBER	DATE	COUNTRY	
1389100-0001	07/11/2013	OHIM	
DESIGN NUMBER	265160		
CLASS	10-07		
1)MONTRES TUDOR S.A., A JOINT STOCK COMPANY ORGANIZED AND EXISTING UNDER THE LAWS OF SWITZERLAND, OF 3, RUE FRANCOIS DUSSAUD, 1211 GENEVE 26, SWITZERLAND			
DATE OF REGISTRATION	26/08/2014		
TITLE	WATCH WRISTLET		
PRIORITY			
PRIORITY NUMBER	DATE	COUNTRY	
140457	28/02/2014	SWITZERLAND	

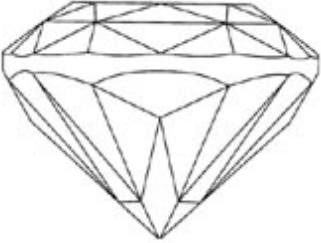
DESIGN NUMBER	262473	
CLASS	19-06	
1)FLAIR PENS LIMITED, AN INDIAN PARTNERSHIP FIRM OF 63, B/C, GOVT. INDUSTRIAL ESTATE, CHARKOP, KANDIVALI (W), MUMBAI - 400067, [MAHARASHTRA] INDIA		
DATE OF REGISTRATION	09/05/2014	
TITLE	PEN	
PRIORITY NA		
DESIGN NUMBER	263099	
CLASS	12-16	
1)DEERE & COMPANY, A US CORPORATION OF ONE JOHN DEERE PLACE, MOLINE, ILLINOIS, 61265 - 8098, USA		
DATE OF REGISTRATION	03/06/2014	
TITLE	STRUCTURAL PILLAR FOR A VEHICLE	
PRIORITY NA		
DESIGN NUMBER	260020	
CLASS	26-06	
1)TATA MOTORS LIMITED, AN INDIAN COMPANY OF BOMBAY HOUSE, 24 HOMI MODY STREET, HUTATMA CHOWK, MUMBAI 400 001, MAHARASHTRA, INDIA		
DATE OF REGISTRATION	31/01/2014	
TITLE	HEAD LAMP OF A VEHICLE	
PRIORITY NA		

DESIGN NUMBER	264944		
CLASS	11-01		
1)KONINKLIJKE ASSCHER DIAMANT MAATSCHAPPIJ B. V., A COMPANY EXISTING UNDER THE LAWS OF THE NETHERLANDS, TOLSTRAAT 127, 1074 VJ AMSTERDAM, THE NETHERLANDS			
DATE OF REGISTRATION	21/08/2014		
TITLE	DIAMOND		
PRIORITY			
PRIORITY NUMBER	DATE	COUNTRY	
002427476-0001	18/03/2014	OHIM	
DESIGN NUMBER	259539		
CLASS	12-16		
1)TATA MOTORS LIMITED, AN INDIAN COMPANY OF BOMBAY HOUSE, 24 HOMI MODY STREET, HUTATMA CHOWK, MUMBAI 400001, MAHARASHTRA, INDIA			
DATE OF REGISTRATION	20/01/2014		
TITLE	CLUTCH RELEASE TOOL FOR AN AUTOMATED MANUAL TRANSMISSION		
PRIORITY NA			