

INTRODUCTION

In view of the recent amendment made in the Designs (Amendment) Rules, 2008 with effect from 17/06/2008, Publication of the matter relating to Designs is being published in the Official Journal of The Patent Office. This Journal is being published on weekly basis on every Friday covering the various proceedings on Designs as required according to the provisions of under Rule 22, 25, 27 and 39 of the Design (Amendment) Rules, 2008. All the enquiries on this Official Journal and other information as required by the public should be addressed to the Controller General of Patents, Designs & Trade Marks. Suggestions and comments are requested from all quarters so that the content can be enriched.

THE DESIGNS ACT 2000
(SECTION 30)
DESIGN ASSIGNMENT

The Design stands in the name of **TERUMO KABUSHIKI KAISHA** registered under the Designs Act, 2000 has been assigned in the Register of Designs in the name as follows:-

| Design No. | Class | Name |
|-------------------|--------------|---|
| 230217 | 24-01 | KARL STORZ GMBH & CO. KG OF, MITTELSTRABE 8, D-78532 TUTTLINGEN, GERMANY, A GERMAN COMPANY |

COPYRIGHT PUBLICATION

| SL NO | REGISTERED DESIGN NUMBERS | RENEWED ON |
|--------------|----------------------------------|-------------------|
| 1. | 197347 | 30.01.2015 |
| 2. | 197348 | 30.01.2015 |
| 3. | 197600 | 30.01.2015 |
| 4. | 197601 | 30.01.2015 |
| 5. | 197602 | 30.01.2015 |
| 6. | 197603 | 30.01.2015 |
| 7. | 199437 | 30.01.2015 |
| 8. | 199438 | 30.01.2015 |
| 9. | 199439 | 30.01.2015 |
| 10. | 256854 | 30.01.2015 |

REGISTRATION OF DESIGNS

The following designs have been registered. They are now open for public inspection. In the following each entry the Date of Registration is shown. The Priority Number, Priority Date and Priority Country are also shown



| | | |
|--|--|---|
| DESIGN NUMBER | 263336 |  |
| CLASS | 13-03 | |
| 1)1) MR. LALIT T. GWALANI AND 2) MRS. SUNITA R. GWALANI, PARTNERS-INDIAN NATIONAL, TRADING AS DOSSAN ENGINEERING COMPANY, A REGISTERED PARTNERSHIP FIRM IN INDIA, HAVING ITS REGISTERED OFFICE AT 205, BAJSON INDUSTRIAL ESTATE, 40, CHAKALA ROAD, ANDHERI (EAST), MUMBAI 400 099, STATE OF MAHARASHTRA, INDIA, OF ABOVE ADDRESS | | |
| DATE OF REGISTRATION | 13/06/2014 | |
| TITLE | SOCKET | |
| PRIORITY NA | | |
| DESIGN NUMBER | 262814 |  |
| CLASS | 12-16 | |
| 1)TAFE MOTORS AND TRACTORS LIMITED, COMPANY INCORPORATED UNDER THE COMPANIES ACT, 1956, HAVING ITS REGISTERED OFFICE AT NO. 77, NUNGAMBAKAM HIGH ROAD, POTTIPATTI PLAZA, 1ST FLOOR, CHENNAI-600034, TAMILNADU, INDIA | | |
| DATE OF REGISTRATION | 22/05/2014 | |
| TITLE | BONNET FOR AGRICULTURAL VEHICLE | |
| PRIORITY NA | | |
| DESIGN NUMBER | 259452 |  |
| CLASS | 14-03 | |
| 1)JAY USHIN LTD., OF GI-48, G.T.KARNAL ROAD, INDUSTRIAL AREA, DELHI – 110033 | | |
| DATE OF REGISTRATION | 17/01/2014 | |
| TITLE | HANDS FREE SWITCHES FOR OPERATING MOBILE IN VEHICLES | |
| PRIORITY NA | | |

| | | |
|---|------------|--|
| DESIGN NUMBER | 259831 |  |
| CLASS | 06-03 | |
| 1)OK PLAY INDIA LTD. AT PLOT NO. 17-18 ROZ-KA-MEO INDUSTRIAL ESTATE, TEHSIL- NUH, DISTRICT – MEWAT, HARYANA-122103 | | |
| DATE OF REGISTRATION | 29/01/2014 | |
| TITLE | TABLE | |
| PRIORITY NA | | |

| | | |
|--|----------------------|---|
| DESIGN NUMBER | 262389 |  |
| CLASS | 12-16 | |
| 1)MINDA INDUSTRIES LIMITED (SWITCH DIVISION), AN INDIAN COMPANY OF VILL. NAWADA FATEPUR, P.O. SIKANDERPUR BADDA, MANESAR, DISTT. GURGAON, HARYANA-122004, INDIA | | |
| DATE OF REGISTRATION | 06/05/2014 | |
| TITLE | BLINKER WITH FLASHER | |
| PRIORITY NA | | |

| | | |
|---|-------------------------|--|
| DESIGN NUMBER | 260899 |  |
| CLASS | 15-03 | |
| 1)NATIONAL AGRO INDUSTRIES, LINK ROAD, INDUSTRIAL AREA-A, OPP. TRANSPORT NAGAR, LUDHIANA-141003 AN INDIAN PARTNERSHIP FIRM WHOSE PARTNERS ARE:- MANMOHAN SINGH, SUKH SOHAN SINGH, TEJDEEP SINGH, HARDEEP SINGH & GURPREET SINGH BEING INDIAN NATIONALS OF THE ABOVE ADDRESS | | |
| DATE OF REGISTRATION | 11/03/2014 | |
| TITLE | SEED PLANTING EQUIPMENT | |
| PRIORITY NA | | |

| | | | |
|---|--|----------------|---|
| DESIGN NUMBER | 261522 | |  |
| CLASS | 14-02 | | |
| 1)ABB TECHNOLOGY AG, AFFOLTERNSTRASSE 44, ZURICH, SWITZERLAND CH-8050, NATIONALITY: SWITZERLAND | | | |
| DATE OF REGISTRATION | 03/04/2014 | | |
| TITLE | A MODULE-MOUNTING BASE FOR AN INDUSTRIAL CONTROL SYSTEM | | |
| PRIORITY | | | |
| PRIORITY NUMBER | DATE | COUNTRY | |
| 29/270,553 | 22/10/2013 | U.S.A. | |
| DESIGN NUMBER | 259303 | |  |
| CLASS | 09-01 | | |
| 1)GODREJ CONSUMER PRODUCTS LIMITED, AN INDIAN COMPANY WHOSE ADDRESS IS PIROJSHANAGAR, EASTERN EXPRESS HIGHWAY, VIKHROLI EAST, MUMBAI-400079, MAHARASHTRA, AN INDIAN COMPANY | | | |
| DATE OF REGISTRATION | 09/01/2014 | | |
| TITLE | BOTTLE | | |
| PRIORITY NA | | | |
| DESIGN NUMBER | 263340 | |  |
| CLASS | 07-02 | | |
| 1)TTK PRESTIGE LIMITED, AN INDIAN COMPANY, INCORPORATED UNDER THE COMPANIES ACT 1956, HAVING ITS PRINCIPAL PLACE OF BUSINESS AT 11TH FLOOR, BRIGADE TOWERS, 135 BRIGADE ROAD, BANGALORE-560025, STATE OF KARNATAKA, INDIA | | | |
| DATE OF REGISTRATION | 13/06/2014 | | |
| TITLE | HANDLE(SET) FOR PRESSURE COOKER | | |
| PRIORITY NA | | | |



| | | | |
|---|---------------|----------------|--|
| DESIGN NUMBER | 259833 | |  |
| CLASS | 06-03 | | |
| 1)OK PLAY INDIA LTD. AT PLOT NO. 17-18 ROZ-KA-MEO INDUSTRIAL ESTATE, TEHSIL-NUH, DISTRICT - MEWAT, HARYANA-122103 | | | |
| DATE OF REGISTRATION | 29/01/2014 | | |
| TITLE | TABLE | | |
| PRIORITY NA | | | |
| DESIGN NUMBER | 261157 | |  |
| CLASS | 09-01 | | |
| 1)A V INTERNATIONAL LIMITED, A CORPORATION ORGANIZED AND EXISTING UNDER THE LAWS OF HONG KONG, WHOSE ADDRESS IS RM 905, 9TH FLOOR, HILDER CENTER NO. 2, SUNG PING STREET, HUNG HOM KOWLOON, HONGKONG | | | |
| DATE OF REGISTRATION | 20/03/2014 | | |
| TITLE | BOTTLE | | |
| PRIORITY NA | | | |
| DESIGN NUMBER | 257187 | |  |
| CLASS | 24-02 | | |
| 1)KONINKLIJKE PHILIPS N.V., A COMPANY ORGANIZED AND EXISTING UNDER THE LAWS OF THE KINGDOM OF THE NETHERLANDS, RESIDING AT EINDHOVEN, WHOSE POST-OFFICE ADDRESS IS HIGH TECH CAMPUS 5, 5656 AE EINDHOVEN, THE NETHERLANDS | | | |
| DATE OF REGISTRATION | 04/10/2013 | | |
| TITLE | DEFIBRILLATOR | | |
| PRIORITY | | | |
| PRIORITY NUMBER | DATE | COUNTRY | |
| 002225607-0001 | 23/04/2013 | OHIM | |

| | | | |
|--|---------------------------|----------------|--|
| DESIGN NUMBER | 261062 | |  |
| CLASS | 07-99 | | |
| 1)MA DESIGN INDIA PRIVATE LIMITED, A COMPANY INCORPORATED IN INDIA HAVING ITS PRINCIPAL PLACE OF BUSINESS AT A-41, SECTOR-80, PHASE-II, NOIDA-201305, U.P. INDIA. | | | |
| DATE OF REGISTRATION | 19/03/2014 | | |
| TITLE | TRAY | | |
| PRIORITY NA | | | |
| DESIGN NUMBER | 262167 | |  |
| CLASS | 14-02 | | |
| 1)COSTABEBER, ETTORE, MAURIZIO, ITALIAN NATIONAL, 36010 ZANE' (VICENZA), VIA LAGO DI LEVICO, 1, ITALY | | | |
| DATE OF REGISTRATION | 30/04/2014 | | |
| TITLE | STEREOLITHOGRAPHY MACHINE | | |
| PRIORITY | | | |
| PRIORITY NUMBER | DATE | COUNTRY | |
| 002374660-0001 | 20/12/2013 | OHIM | |
| DESIGN NUMBER | 259334 | |  |
| CLASS | 18-99 | | |
| 1)RAJEEV BHASKARAN. (INDIAN NATIONAL) HAVING OFFICE AT AA-66, KAILASH INDUSTRIAL COMPLEX, PARK SITE, VIKHROLI (WEST), MUMBAI-400 079, MAHARASHTRA, INDIA. | | | |
| DATE OF REGISTRATION | 10/01/2014 | | |
| TITLE | COLD LAMINATION MACHINE | | |
| PRIORITY NA | | | |

| | | |
|--|-------------|--|
| DESIGN NUMBER | 261934 |  |
| CLASS | 23-04 | |
| 1)M/S V-GUARD INDUSTRIES LTD., AN INDIAN COMPANY INCORPORATED UNDER THE COMPANIES ACT OF 1956 WHOSE ADDRESS IS 33/2905 F, VENNALA HIGH SCHOOL ROAD, VENNALA, KOCHI-682028, KERALA STATE, INDIA | | |
| DATE OF REGISTRATION | 22/04/2014 | |
| TITLE | CEILING FAN | |
| PRIORITY NA | | |

| | | |
|--|-----------------|--|
| DESIGN NUMBER | 264159 |  |
| CLASS | 15-05 | |
| 1)SAMSUNG ELECTRONICS CO., LTD. 129, SAMSUNG-RO, YEONGTONG-GU, SUWON-SI, GYEONGGI-DO, 443-742, REPUBLIC OF KOREA, A COMPANY OF REPUBLIC OF KOREA | | |
| DATE OF REGISTRATION | 18/07/2014 | |
| TITLE | WASHING MACHINE | |
| PRIORITY NA | | |

| | | |
|---|----------------------|--|
| DESIGN NUMBER | 259146 |  |
| CLASS | 19-06 | |
| 1)MARKANDEYAN SENTHIL KUMAR, OF 1/280 RAJARATHINAM NAGAR, SINGARATHOTTAM, VANDALUR, CHENNAI-600048, TAMIL NADU, INDIA, AN INDIAN NATIONAL | | |
| DATE OF REGISTRATION | 30/12/2013 | |
| TITLE | STATIONERY EQUIPMENT | |
| PRIORITY NA | | |

| | | |
|---|------------|--|
| DESIGN NUMBER | 262817 |  |
| CLASS | 12-09 | |
| 1)TAFE MOTORS AND TRACTORS LIMITED, COMPANY INCORPORATED UNDER THE COMPANIES ACT, 1956, HAVING ITS REGISTERED OFFICE AT NO. 77, NUNGAMBAKAM HIGH ROAD, POTTIPATTI PLAZA, 1ST FLOOR, CHENNAI-600034, TAMILNADU, INDIA | | |
| DATE OF REGISTRATION | 22/05/2014 | |
| TITLE | TRACTOR | |
| PRIORITY NA | | |
| DESIGN NUMBER | 259834 |  |
| CLASS | 06-01 | |
| 1)OK PLAY INDIA LTD. AT PLOT NO. 17-18 ROZ-KA MEO INDUSTRIAL ESTATE, TEHSIL -NUH, DISTRICT - MEWAT, HARYANA-122103 | | |
| DATE OF REGISTRATION | 29/01/2014 | |
| TITLE | CHAIR | |
| PRIORITY NA | | |
| DESIGN NUMBER | 261158 |  |
| CLASS | 09-01 | |
| 1)A V INTERNATIONAL LIMITED, A CORPORATION ORGANIZED AND EXISTING UNDER THE LAWS OF HONG KONG, WHOSE ADDRESS IS RM 905, 9TH FLOOR, HILDER CENTER NO. 2, SUNG PING STREET, HUNG HOM KOWLOON, HONGKONG | | |
| DATE OF REGISTRATION | 20/03/2014 | |
| TITLE | BOTTLE | |
| PRIORITY NA | | |

| | | |
|---|----------------|--|
| DESIGN NUMBER | 261386 |  |
| CLASS | 03-01 | |
| 1)MA DESIGN INDIA PRIVATE LIMITED, A COMPANY INCORPORATED IN INDIA HAVING ITS PRINCIPAL PLACE OF BUSINESS AT A-41, SECTOR-80, PHASE-II, NOIDA-201305, U.P. INDIA | | |
| DATE OF REGISTRATION | 31/03/2014 | |
| TITLE | JEWELLERY BOX | |
| PRIORITY NA | | |
| DESIGN NUMBER | 261063 |  |
| CLASS | 07-99 | |
| 1)MA DESIGN INDIA PRIVATE LIMITED, A COMPANY INCORPORATED IN INDIA HAVING ITS PRINCIPAL PLACE OF BUSINESS AT A-41, SECTOR-80, PHASE-II, NOIDA-201305, U.P. INDIA. | | |
| DATE OF REGISTRATION | 19/03/2014 | |
| TITLE | TRAY | |
| PRIORITY NA | | |
| DESIGN NUMBER | 266186 |  |
| CLASS | 05-05 | |
| 1)M/S. BIBA APPARELS PRIVATE LIMITED, AN INDIAN PRIVATE LIMITED COMPANY INCORPORATED UNDER THE PROVISION OF THE COMPANIES ACT, 1956, AND HAVING ITS'S REGISTERED OFFICE AT RELIABLE HOUSE, SITUATED AT HANUMAN SILK MILL COMPOUND, KANJURMARG (WEST), OPP. HUMA MALL, MUMBAI-400 078 MAHARASHTRA, INDIA. | | |
| DATE OF REGISTRATION | 29/09/2014 | |
| TITLE | TEXTILE FABRIC | |
| PRIORITY NA | | |



| | | |
|--|-------------------|--|
| DESIGN NUMBER | 261489 |  |
| CLASS | 09-05 | |
| 1)FIXWELL INDUSTRIES, 167, ARIHANT NAGAR JAIN COLONY, PUNJABI BAGH WEST, NEAR MADIPUR METRO STATION, NEW DELHI-110026, INDIA. (AN INDIAN PROPRIETORSHIP FIRM WHOSE PROPRIETOR IS :-SH. ATUL JAIN. AN INDIAN NATIONAL OF THE ABOVE ADDRESS | | |
| DATE OF REGISTRATION | 02/04/2014 | |
| TITLE | TUBE FOR ADHESIVE | |
| PRIORITY NA | | |
| DESIGN NUMBER | 261607 |  |
| CLASS | 06-07 | |
| 1)MA DESIGN INDIA PRIVATE LIMITED, A COMPANY INCORPORATED IN INDIA HAVING ITS PRINCIPAL PLACE OF BUSINESS AT A-41, SECTOR-80, PHASE-II, NOIDA-201305, U.P. INDIA | | |
| DATE OF REGISTRATION | 09/04/2014 | |
| TITLE | PHOTO FRAME | |
| PRIORITY NA | | |
| DESIGN NUMBER | 260601 |  |
| CLASS | 09-01 | |
| 1)DART INDUSTRIES INC., A CORPORATION FOUNDED UNDER THE LAWS OF DELAWARE, U.S.A. OF 14901 SOUTH ORANGE BLOSSOM TRAIL, ORLANDO, FLORIDA 32837, USA | | |
| DATE OF REGISTRATION | 25/02/2014 | |
| TITLE | BOTTLE | |
| PRIORITY NA | | |

| | | |
|--|-----------------------------|--|
| DESIGN NUMBER | 262082 |  |
| CLASS | 09-03 | |
| 1)SHRI MAA DISTRIBUTIONS (INDIA) PVT. LTD. HAVING ADDRESS AT 1107, HEMKUNT HOUSE, 6 RAJENDRA PLACE, NEW DELHI-110008. NATIONALITY-A COMPANY INCORPORATED IN INDIA | | |
| DATE OF REGISTRATION | 25/04/2014 | |
| TITLE | CASE FOR HOLDING CHOCOLATES | |
| PRIORITY NA | | |

| | | |
|--|------------|--|
| DESIGN NUMBER | 261910 |  |
| CLASS | 25-02 | |
| 1)THE SUPREME INDUSTRIES LTD., (AN INDIAN PUBLIC LIMITED COMPANY), 601 CENTRAL PLAZA, 2/6, SARAT BOSE ROAD, KOLKATA - 700020, WEST BENGAL, INDIA | | |
| DATE OF REGISTRATION | 22/04/2014 | |
| TITLE | MANHOLE | |
| PRIORITY NA | | |

| | | |
|---|------------|---|
| DESIGN NUMBER | 263405 |  |
| CLASS | 06-11 | |
| 1)MR. MAHESH KUMAR CHOUDHARY AND MRS. BASU DEVI CHOUDHARY, BOTH INDIAN DIRECTORS, TRADING AS M/S SARASWATI GLOBAL PVT. LTD., AN INDIAN COMPANY OF 3, GANESH COLONY, BEHIND GOLIMAR GARDEN, AMER ROAD, JAIPUR-302002, RAJASTHAN, INDIA | | |
| DATE OF REGISTRATION | 16/06/2014 | |
| TITLE | CARPET | |
| PRIORITY NA | | |

| | | |
|--|--------------------------------|--|
| DESIGN NUMBER | 263748 |  |
| CLASS | 12-16 | |
| 1)MARCOPOLO S.A., OF BRAZILIAN ADDRESS AT AVENIDA MARCOPOLO, N° 280, CAXIAS DO SUL, RIO GRANDE DO SUL-CEP: 95086-200, BRAZIL | | |
| DATE OF REGISTRATION | 30/06/2014 | |
| TITLE | DASHBOARD FOR BUS | |
| PRIORITY NA | | |
| DESIGN NUMBER | 257455 |  |
| CLASS | 02-04 | |
| 1)M/S. AERO CLUB, OF THE ADDRESS 867, JOSHI ROAD, KAROL BAGH, NEW DELHI-110005 | | |
| DATE OF REGISTRATION | 11/10/2013 | |
| TITLE | FOOTWEAR | |
| PRIORITY NA | | |
| DESIGN NUMBER | 261406 |  |
| CLASS | 13-03 | |
| 1)LARSEN & TOUBRO LIMITED, AN INDIAN COMPANY INCORPORATED UNDER THE COMPANIES ACT, 1956 OF L & T HOUSE, BALLARD ESTATE, MUMBAI 400 001, STATE OF MAHARASHTRA, INDIA | | |
| DATE OF REGISTRATION | 31/03/2014 | |
| TITLE | CHANGEOVER SWITCH DISCONNECTOR | |
| PRIORITY NA | | |

| | | | |
|---|--|----------------|--|
| DESIGN NUMBER | 262280 | |  |
| CLASS | 24-01 | | |
| 1)PIRAMAL ENTERPRISES LIMITED, HAVING NATIONALITY OF INDIA OF THE ADDRESS PIRAMAL TOWER, GANPATRAO KADAM MARG, LOWER PAREL, MUMBAI 400013, INDIA | | | |
| DATE OF REGISTRATION | 02/05/2014 | | |
| TITLE | MEDICAL DEVICE FOR ANALYSIS OF BLOOD SAMPLES | | |
| PRIORITY NA | | | |
| DESIGN NUMBER | 261118 | |  |
| CLASS | 08-06 | | |
| 1)DILIPBHAI BACHUBHAI HIRPARA (INDIAN NATIONALS) AND SOLE PROPRIETOR OF JANKI DIE-CAST (INDIAN PROPRIETORSHIP CONCERN) HAVING PLACE OF BUSINESS AT-PLOT NO. 834, AJI INDUSTRIAL AREA, NR; SITARAM WAY BRIDGE, OPP: MUNICIPAL WORKSHOP, BHAVNAGAR ROAD, RAJKOT-GUJARAT (INDIA) | | | |
| DATE OF REGISTRATION | 20/03/2014 | | |
| TITLE | HANDLE | | |
| PRIORITY NA | | | |
| DESIGN NUMBER | 261708 | |  |
| CLASS | 13-03 | | |
| 1)INTELLIGENT ENERGY LIMITED, A CORPORATION ORGANIZED AND EXISTING UNDER THE LAWS OF UNITED KINGDOM, OF CHARNWOOD BUILDING, HOLYWELL PARK, ASHBY ROAD, LOUGHBOROUGH, LEICESTERSHIRE, UNITED KINGDOM LE11 3GB, | | | |
| DATE OF REGISTRATION | 11/04/2014 | | |
| TITLE | USB ADAPTER | | |
| PRIORITY | | | |
| PRIORITY NUMBER | DATE | COUNTRY | |
| 29/469,662 | 11/10/2013 | U.S.A. | |

| | | | |
|---|-------------------------------------|----------------|---|
| DESIGN NUMBER | 261966 | |  |
| CLASS | 15-09 | | |
| 1)SINTOKOGIO, LTD., A JAPANESE COMPANY OF 11-11, NISHIKI 1-CHOME, NAKA-KU, NAGOYA-SHI, AICHI 4600003, JAPAN | | | |
| DATE OF REGISTRATION | 23/04/2014 | | |
| TITLE | SIDE PLATES FOR SHOTBLAST MACHINE | | |
| PRIORITY | | | |
| PRIORITY NUMBER | DATE | COUNTRY | |
| 2013-028931 | 10/12/2013 | JAPAN | |
| DESIGN NUMBER | 263399 | |  |
| CLASS | 06-11 | | |
| 1)MR. MAHESH KUMAR CHOUDHARY AND MRS. BASU DEVI CHOUDHARY, BOTH INDIAN DIRECTORS, TRADING AS M/S SARASWATI GLOBAL PVT. LTD., AN INDIAN COMPANY OF 3, GANESH COLONY, BEHIND GOLIMAR GARDEN, AMER ROAD, JAIPUR-302002, RAJASTHAN, INDIA | | | |
| DATE OF REGISTRATION | 16/06/2014 | | |
| TITLE | CARPET | | |
| PRIORITY NA | | | |
| DESIGN NUMBER | 261399 | |  |
| CLASS | 23-01 | | |
| 1)DANFOSS A/S, A DANISH COMPANY, OF NORDBORGVEJ 81, DK-6430 NORDBORG, DENMARK | | | |
| DATE OF REGISTRATION | 31/03/2014 | | |
| TITLE | SIGHT GLASS FOR REFRIGERATION VALVE | | |
| PRIORITY | | | |
| PRIORITY NUMBER | DATE | COUNTRY | |
| 002317990-0002 | 30/09/2013 | OHIM | |

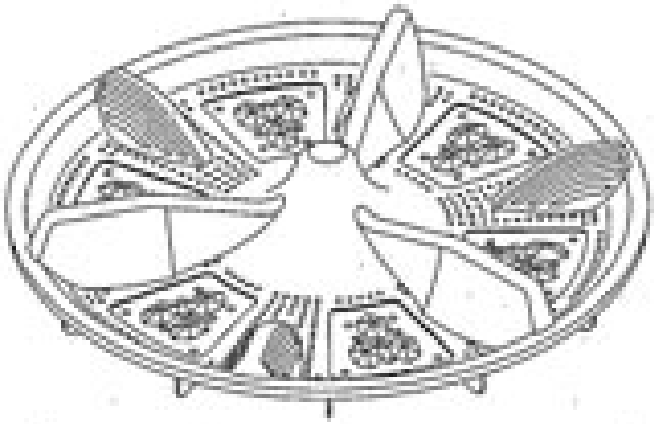
| | | |
|--|-------------------------------|--|
| DESIGN NUMBER | 262010 |  |
| CLASS | 15-05 | |
| 1) PANASONIC CORPORATION, A JAPANESE COMPANY ORGANIZED AND EXISTING UNDER THE LAWS OF JAPAN, OF 1006, OAZA KADOMA, KADOMA-SHI, OSAKA 571-8501, JAPAN | | |
| DATE OF REGISTRATION | 25/04/2014 | |
| TITLE | PULSATOR FOR WASHING MACHINES | |
| PRIORITY NA | | |

| | | |
|--|------------|--|
| DESIGN NUMBER | 261894 |  |
| CLASS | 08-09 | |
| 1)(1) NILESHBHAI ASHAR AND (2) ANJANABEN ASHAR BOTH INDIAN NATIONAL PARTNERS OF AJIT ENTERPRISE AN INDIAN PARTNERSHIP FIRM HAVING ITS PRINCIPAL PLACE OF BUSINESS AT PLOT NO. 4710, GIDC-III, OPP. SENOR METALS, DARED, JAMNAGAR-361 004, GUJARAT-INDIA | | |
| DATE OF REGISTRATION | 21/04/2014 | |
| TITLE | GATE HOOK | |
| PRIORITY NA | | |

| | | |
|---|------------|---|
| DESIGN NUMBER | 263396 |  |
| CLASS | 06-11 | |
| 1) MR. MAHESH KUMAR CHOUDHARY AND MRS. BASU DEVI CHOUDHARY, BOTH INDIAN DIRECTORS, TRADING AS M/S SARASWATI GLOBAL PVT. LTD., AN INDIAN COMPANY OF 3, GANESH COLONY, BEHIND GOLIMAR GARDEN, AMER ROAD, JAIPUR-302002, RAJASTHAN, INDIA | | |
| DATE OF REGISTRATION | 16/06/2014 | |
| TITLE | CARPET | |
| PRIORITY NA | | |

| | | |
|--|-----------------------------------|--|
| DESIGN NUMBER | 263615 |  |
| CLASS | 24-01 | |
| 1)MR. SACHIN G. LOKAPURE (INDIA). A THE PROPRIETOR OF SAGLO® RESEARCH EQUIPMENT HAVING ITS PRINCIPAL PLACE OF BUSINESS 5099, NEAR ASHA TALKIES, OPP. OMKAR APARTMENT, SHANIWAR PETH, MIRAJ-416410, DIST-SANGLI, MAHARASHTRA, INDIA | | |
| DATE OF REGISTRATION | 24/06/2014 | |
| TITLE | INTRAUTERINE CONTRACEPTIVE DEVICE | |
| PRIORITY NA | | |
| DESIGN NUMBER | 263653 |  |
| CLASS | 12-15 | |
| 1)M/S. JK TYRE & INDUSTRIES LIMITED, OF 7, COUNCIL HOUSE STREET, KOLKATA-700001, INDIA, AN INDIAN COMPANY | | |
| DATE OF REGISTRATION | 24/06/2014 | |
| TITLE | TYRE | |
| PRIORITY NA | | |
| DESIGN NUMBER | 263880 |  |
| CLASS | 23-01 | |
| 1)M. RAJENDRA PRASAD, 58-24-51, GAVARA STREET, BUTCHIRAJUPALEM, NAD KOTHA ROAD, VISAKHAPATNAM, ANDHRA PRADESH-530027, INDIA, AN INDIAN NATIONAL | | |
| DATE OF REGISTRATION | 04/07/2014 | |
| TITLE | FILTER FOR WATER BOTTLE | |
| PRIORITY NA | | |

| | | | |
|---|---|----------------|---|
| DESIGN NUMBER | 263941 | |  |
| CLASS | 08-08 | | |
| 1)(1) JAGDISHBHAI C. LUNAGARIYA (2) NALINBHAI K. LUNAGARIYA AND (3) ALPESHBHAI K. LUNAGARIYA ALL INDIAN NATIONAL PARTNER OF ALTEC HARDWARE AN INDIAN PARTNERSHIP FIRM HAVING ITS PRINCIPAL PLACE OF BUSINESS AT ADDRESS: 5-AJI VASAHT, 80 FEET ROAD, BEHIND P. M. DIESELS RAJKOT-3, GUJARAT-INDIA | | | |
| DATE OF REGISTRATION | 09/07/2014 | | |
| TITLE | KEY HANGER | | |
| PRIORITY NA | | | |
| DESIGN NUMBER | 255779 | |  |
| CLASS | 23-01 | | |
| 1)PENTAIR RESIDENTIAL FILTRATION, LLC, 5730 NORTH GLEN PARK ROAD, GLENDALE, WI 53209, U.S.A., NATIONALITY: U.S.A. | | | |
| DATE OF REGISTRATION | 12/08/2013 | | |
| TITLE | VALVE HOUSING FOR A RESIDENTIAL FILTRATION UNIT | | |
| PRIORITY | | | |
| PRIORITY NUMBER | DATE | COUNTRY | |
| 29/445,477 | 12/02/2013 | U.S.A. | |
| DESIGN NUMBER | 261398 | |  |
| CLASS | 23-01 | | |
| 1)DANFOSS A/S, A DANISH COMPANY, OF NORDBORGVEJ 81, DK-6430 NORDBORG, DENMARK | | | |
| DATE OF REGISTRATION | 31/03/2014 | | |
| TITLE | SIGHT GLASS FOR REFRIGERATION VALVE | | |
| PRIORITY | | | |
| PRIORITY NUMBER | DATE | COUNTRY | |
| 002317990-0001 | 30/09/2013 | OHIM | |

| | | |
|--|-----------------------------|--|
| DESIGN NUMBER | 261893 |  |
| CLASS | 08-09 | |
| 1)(1) NILESHBHAI ASHAR AND (2) ANJANABEN ASHAR BOTH INDIAN NATIONAL PARTNERS OF AJIT ENTERPRISE AN INDIAN PARTNERSHIP FIRM HAVING ITS PRINCIPAL PLACE OF BUSINESS AT PLOT NO. 4710, GIDC-III, OPP. SENOR METALS, DARED, JAMNAGAR-361 004, GUJARAT-INDIA | | |
| DATE OF REGISTRATION | 21/04/2014 | |
| TITLE | CAM BOLTS FOR LOCK THE DOOR | |
| PRIORITY NA | | |
| DESIGN NUMBER | 259836 |  |
| CLASS | 06-01 | |
| 1)OK PLAY INDIA LTD. AT PLOT NO. 17-18 ROZ-KA-MEO INDUSTRIAL ESTATE, TEHSIL - NUH, DISTRICT - MEWAT, HARYANA-122103 | | |
| DATE OF REGISTRATION | 29/01/2014 | |
| TITLE | STOOL | |
| PRIORITY NA | | |
| DESIGN NUMBER | 261077 |  |
| CLASS | 06-07 | |
| 1)MA DESIGN INDIA PRIVATE LIMITED, A COMPANY INCORPORATED IN INDIA HAVING ITS PRINCIPAL PLACE OF BUSINESS AT A-41, SECTOR-80, PHASE-II, NOIDA-201305, U.P. INDIA. | | |
| DATE OF REGISTRATION | 19/03/2014 | |
| TITLE | PHOTO FRAME | |
| PRIORITY NA | | |



| | | |
|--|------------|---|
| DESIGN NUMBER | 263402 |  |
| CLASS | 06-11 | |
| 1)MR. MAHESH KUMAR CHOUDHARY AND MRS. BASU DEVI CHOUDHARY, BOTH INDIAN DIRECTORS, TRADING AS M/S SARASWATI GLOBAL PVT. LTD., AN INDIAN COMPANY OF 3, GANESH COLONY, BEHIND GOLIMAR GARDEN, AMER ROAD, JAIPUR-302002, RAJASTHAN, INDIA | | |
| DATE OF REGISTRATION | 16/06/2014 | |
| TITLE | CARPET | |
| PRIORITY NA | | |

| | | |
|---|------------|--|
| DESIGN NUMBER | 263763 |  |
| CLASS | 08-06 | |
| 1)KAPILBHAI BALVANTRAI VYAS AND JIGNESHBHAI CHHAGANBHAI GOHEL BOTH INDIAN NATIONAL PARTNER OF RATNAPRABHA HARDWARE AN INDIAN PARTNERSHIP FIRM HAVING ITS PRINCIPAL PLACE OF BUSINESS AT ADDRESS:- 6, PARSANA SOCIETY, 50 FEET ROAD, KOTHARIYA MAIN ROAD, RAJKOT-2. GUJARAT-INDIA | | |
| DATE OF REGISTRATION | 30/06/2014 | |
| TITLE | HANDLE | |
| PRIORITY NA | | |



| | | |
|--|------------|---|
| DESIGN NUMBER | 263896 |  |
| CLASS | 09-03 | |
| 1)REXAM HEALTHCARE PACKAGING INC., A CORPORATION ORGANIZED AND EXISTING UNDER THE LAWS OF THE STATE OF DELAWARE AND HAVING A PLACE OF BUSINESS AT 800 CORPORATE GROVE DRIVE, BUFFALO GROVE, IL 60089, USA | | |
| DATE OF REGISTRATION | 04/07/2014 | |
| TITLE | CONTAINER | |
| PRIORITY | | |
| PRIORITY NUMBER | DATE | COUNTRY |
| 29/478,587 | 07/01/2014 | U.S.A. |

| | | | |
|---|---------------------------------------|----------------|--|
| DESIGN NUMBER | 260663 | |  |
| CLASS | 08-06 | | |
| 1)(1) SANJAYBHAI RAVJIBHAI PATODIYA (2) ASHWINBHAI NATHABHAI SAKHIYA (3) PRAVINBHAI VALJIBHAI KAPADIYA (ALL THE PARTNERS ARE ADULT & INDIAN NATIONAL) PARTNERS OF SHIV SHAKTI METAL (INDIAN PARTNER SHIP FIRM) HAVING PLACE OF BUSINESS AT: PARMESHWAR MAIN ROAD, OP: JAYANT CASTING, ATIKA DHEBAR ROAD (SOUTH), RAJKOT-GUJARAT-(INDIA) | | | |
| DATE OF REGISTRATION | 28/02/2014 | | |
| TITLE | HANDLE | | |
| PRIORITY NA | | | |
| DESIGN NUMBER | 260306 | |  |
| CLASS | 24-02 | | |
| 1)RAHUL GUPTA, AN INDIAN CITIZEN, RESIDING AT HOUSE NO. 83, POCKET H-19, SECTOR-7, ROHINI, DELHI-110085, INDIA | | | |
| DATE OF REGISTRATION | 13/02/2014 | | |
| TITLE | TESTING STRIP FOR MEDICAL DIAGNOSTICS | | |
| PRIORITY NA | | | |
| DESIGN NUMBER | 262918 | |  |
| CLASS | 24-02 | | |
| 1)HTL - STREFA SPÓLKA AKCYJNA, A COMPANY ORGANIZED AND EXISTING UNDER THE LAWS OF POLAND HAVING PLACE OF BUSINESS AT ADAMÓWEK 7, PL 95-035 OZORKÓW., POLAND | | | |
| DATE OF REGISTRATION | 27/05/2014 | | |
| TITLE | SKIN INCISION DEVICE | | |
| PRIORITY | | | |
| PRIORITY NUMBER | DATE | COUNTRY | |
| 002406678-0001 | 18/02/2014 | OHIM | |

| | | |
|---|--|--|
| DESIGN NUMBER | 261407 |  |
| CLASS | 13-03 | |
| 1) LARSEN & TOUBRO LIMITED, AN INDIAN COMPANY INCORPORATED UNDER THE COMPANIES ACT, 1956 OF L & T HOUSE, BALLARD ESTATE, MUMBAI 400001, STATE OF MAHARASHTRA, INDIA | | |
| DATE OF REGISTRATION | 31/03/2014 | |
| TITLE | CENTER OPERATED SWITCH DISCONNECTOR | |
| PRIORITY NA | | |
| DESIGN NUMBER | 261470 |  |
| CLASS | 15-09 | |
| 1) ENDICO POWER TOOLS (INDIA) 1276/1, STREET NO. 3, SHIMLAPURI, LUDHIANA-3, (PB.), INDIA, A PROPRIETORSHIP FIRM | | |
| DATE OF REGISTRATION | 02/04/2014 | |
| TITLE | BEARING COVER FOR WOOD WORKING MACHINE | |
| PRIORITY NA | | |
| DESIGN NUMBER | 261709 |  |
| CLASS | 09-01 | |
| 1) SHRI INDERMAL P. JAIN, BLUPLAST INDUSTRIES LTD., 113/114 VIVEK INDUSTRIAL ESTATE, USWALA ROAD, GOREGAON (EAST), MUMBAI-400063, | | |
| DATE OF REGISTRATION | 11/04/2014 | |
| TITLE | FLASK | |
| PRIORITY NA | | |

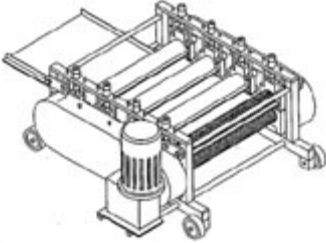

| | | |
|---|-----------------------|--|
| DESIGN NUMBER | 260600 |  |
| CLASS | 09-01 | |
| 1)DART INDUSTRIES INC., A CORPORATION FOUNDED UNDER THE LAWS OF DELAWARE, U.S.A. OF 14901 SOUTH ORANGE BLOSSOM TRAIL, ORLANDO, FLORIDA 32837, USA | | |
| DATE OF REGISTRATION | 25/02/2014 | |
| TITLE | BOTTLE | |
| PRIORITY NA | | |
| DESIGN NUMBER | 263564 |  |
| CLASS | 09-01 | |
| 1)KIRTI DAL MILLS LTD, A COMPANY REGISTERED IN INDIA, HAVING ITS REGISTERED OFFICE AT 79-C, MARKET YARD LATUR-413512, STATE OF MAHARASHTRA, INDIA, OF ABOVE ADDRESS | | |
| DATE OF REGISTRATION | 20/06/2014 | |
| TITLE | BOTTLE | |
| PRIORITY NA | | |
| DESIGN NUMBER | 262776 |  |
| CLASS | 31-00 | |
| 1)PRADEEPKUMAR NANDLAL DHOOT, INDIAN NATIONAL OF GANGAPURWALA, 2275 ADAT BAZAR, AHMEDNAGAR-414001, MAHARASHTRA, INDIA. | | |
| DATE OF REGISTRATION | 21/05/2014 | |
| TITLE | BASE OF MIXER GRINDER | |
| PRIORITY NA | | |

| | | | |
|---|---|----------------|---|
| DESIGN NUMBER | 261247 | | |
| CLASS | 09-01 | | |
| 1)EMAMI LIMITED, AN INDIAN COMPANY HAVING ITS REGISTERED OFFICE AT ‘EMAMI TOWER’, 687 ANANDAPUR, EM BYPASS, KOLKATA 700 017, WEST BENGAL, INDIA. | | | |
| DATE OF REGISTRATION | 26/03/2014 | | |
| TITLE | BOTTLE | | |
| PRIORITY NA | | |  |
| DESIGN NUMBER | 261404 | | |
| CLASS | 13-03 | | |
| 1)LARSEN & TOUBRO LIMITED, AN INDIAN COMPANY INCORPORATED UNDER THE COMPANIES ACT, 1956 OF L & T HOUSE, BALLARD ESTATE, MUMBAI 400 001, STATE OF MAHARASHTRA, INDIA | | | |
| DATE OF REGISTRATION | 31/03/2014 | | |
| TITLE | ENCLOSURE FOR MOTOR CONTROL METERING PROTECTION RELAY | |  |
| PRIORITY NA | | | |
| DESIGN NUMBER | 261705 | | |
| CLASS | 02-04 | |  |
| 1)COLE HAAN LLC, A CORPORATION ORGANIZED AND EXISTING UNDER THE LAWS OF USA, OF 45 WEST 18TH STREET, THIRD FLOOR, NEW YORK, NY 10011, UNITED STATES OF AMERICA | | | |
| DATE OF REGISTRATION | 11/04/2014 | | |
| TITLE | SHOE SOLE | | |
| PRIORITY | | | |
| PRIORITY NUMBER | DATE | COUNTRY | |
| 29/469,728 | 14/10/2013 | U.S.A. | |

| | | |
|---|--------------------------------------|--|
| DESIGN NUMBER | 261766 |  |
| CLASS | 15-05 | |
| 1)NARAYANAN NAMBOODIRI AND DAMODAR AVANOR, TRADING IN PARTNERSHIP AS LOHASHILPI AT ANAMANGAD, PERINTHALMANNA-679 357, MALAPPURAM DISTRICT, KERALA | | |
| DATE OF REGISTRATION | 15/04/2014 | |
| TITLE | AUTOMATIC RUBBER SHEETING MACHINE | |
| PRIORITY NA | | |
| DESIGN NUMBER | 263718 |  |
| CLASS | 14-03 | |
| 1)AASHIQUEE IS A PROPRIETORSHIP FIRM OF 107 CHANDER NAGAR, 1ST FLOOR JANAKPURI, NEW DELHI-110058, INDIA | | |
| DATE OF REGISTRATION | 27/06/2014 | |
| TITLE | COMPUTER | |
| PRIORITY NA | | |
| DESIGN NUMBER | 262810 |  |
| CLASS | 26-06 | |
| 1)TAFE MOTORS AND TRACTORS LIMITED, COMPANY INCORPORATED UNDER THE COMPANIES ACT, 1956, HAVING ITS REGISTERED OFFICE AT NO. 77, NUNGAMBAKAM HIGH ROAD, POTTIPATTI PLAZA, 1ST FLOOR, CHENNAI-600034, TAMILNADU, INDIA | | |
| DATE OF REGISTRATION | 22/05/2014 | |
| TITLE | REAR COMBINATION LAMP FOR AUTOMOBILE | |
| PRIORITY NA | | |

| | | |
|---|----------------------|--|
| DESIGN NUMBER | 261508 |  |
| CLASS | 11-01 | |
| 1)M/S. SUNJEWELS INTERNATIONAL PVT. LTD, A COMPANY INCORPORATED UNDER THE COMPANIES ACT 1956 IN INDIA AND HAVING ITS REGISTERED ADDRESS AT 116 SDF-IV, SEEPZ, SEZ, ANDHERI EAST, MUMBAI-400096, MAHARASHTRA, INDIA | | |
| DATE OF REGISTRATION | 03/04/2014 | |
| TITLE | PENDANT FOR NECKLACE | |
| PRIORITY NA | | |
| DESIGN NUMBER | 261717 |  |
| CLASS | 15-02 | |
| 1)KARNAL AGRI IMPEX PVT. LTD., PLOT NO. 262, SECTOR-3, HSIIDC, KARNAL-132001, HARYANA | | |
| DATE OF REGISTRATION | 15/04/2014 | |
| TITLE | PUMP | |
| PRIORITY NA | | |
| DESIGN NUMBER | 261925 |  |
| CLASS | 09-01 | |
| 1)MR. SACHIN SACHDEV, MRS. MANASI SACHDEV AND MR. RAVI CHAWLA ALL PARTNERS OF M/S NAYASA MULTIPLAST A PARTNERSHIP CONCERN DULY REGISTERED UNDER THE PARTNERSHIP ACT, 1932 HAVING ADDRESS AT PLOT NOS. 225, 225, 227 AND 228, VILLAGE VELA BATHRI, TAHASIL HAROLI, DISTRICT UNA-732141, HIMACHAL PRADESH | | |
| DATE OF REGISTRATION | 22/04/2014 | |
| TITLE | BOTTLE | |
| PRIORITY NA | | |

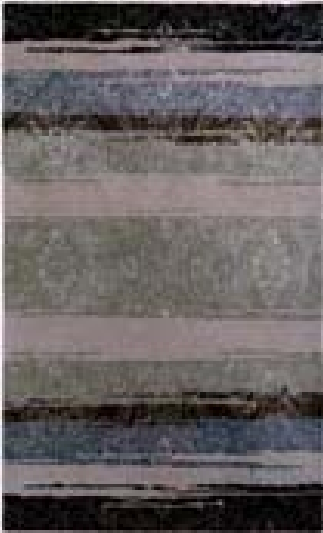
| | | |
|---|--------------------------|--|
| DESIGN NUMBER | 263832 |  |
| CLASS | 08-07 | |
| 1)GODREJ & BOYCE MFG. CO. LTD. OF LOCKS DIVISION (PLANT-18), PIROJSHANAGAR, VIKHROLI, MUMBAI - 400079, MAHARASHTRA, INDIA, INDIAN COMPANY | | |
| DATE OF REGISTRATION | 02/07/2014 | |
| TITLE | PADLOCK | |
| PRIORITY NA | | |
| DESIGN NUMBER | 261315 |  |
| CLASS | 25-02 | |
| 1)GUNJAL VIJAY SHIVAJIRAO, AMBIKANAGAR, KOTAMGAON ROAD, A/P-LASALGAON, TAL-NIPHAD, DIST- NASHIK, STATE-MAHARASHTRA, INDIA, PIN-422306, INDIAN | | |
| DATE OF REGISTRATION | 28/03/2014 | |
| TITLE | PREFABRICATED BEAM FRAME | |
| PRIORITY NA | | |
| DESIGN NUMBER | 260602 |  <small>PERPECTIVE VIEW</small> |
| CLASS | 09-01 | |
| 1)DART INDUSTRIES INC., A CORPORATION FOUNDED UNDER THE LAWS OF DELAWARE, U.S.A. OF 14901 SOUTH ORANGE BLOSSOM TRAIL, ORLANDO, FLORIDA 32837, USA | | |
| DATE OF REGISTRATION | 25/02/2014 | |
| TITLE | BOTTLE | |
| PRIORITY NA | | |

| | | |
|--|-------------------|---|
| DESIGN NUMBER | 261490 |  |
| CLASS | 09-05 | |
| 1)FIXWELL INDUSTRIES, 167, ARIHANT NAGAR JAIN COLONY, PUNJABI BAGH WEST, NEAR MADIPUR METRO STATION, NEW DELHI-110026, INDIA. (AN INDIAN PROPRIETORSHIP FIRM WHOSE PROPRIETOR IS :-SH. ATUL JAIN. AN INDIAN NATIONAL OF THE ABOVE ADDRESS | | |
| DATE OF REGISTRATION | 02/04/2014 | |
| TITLE | TUBE FOR ADHESIVE | |
| PRIORITY NA | | |
| DESIGN NUMBER | 263404 |  |
| CLASS | 06-11 | |
| 1)MR. MAHESH KUMAR CHOUDHARY AND MRS. BASU DEVI CHOUDHARY, BOTH INDIAN DIRECTORS, TRADING AS M/S SARASWATI GLOBAL PVT. LTD., AN INDIAN COMPANY OF 3, GANESH COLONY, BEHIND GOLIMAR GARDEN, AMER ROAD, JAIPUR-302002, RAJASTHAN, INDIA | | |
| DATE OF REGISTRATION | 16/06/2014 | |
| TITLE | CARPET | |
| PRIORITY NA | | |
| DESIGN NUMBER | 263747 |  |
| CLASS | 12-08 | |
| 1)MARCOPOLO S.A., NATIONALITY: BRAZILIAN ADDRESS AT AVENIDA MARCOPOLO, N° 280, CAXIAS DO SUL, RIO GRANDE DO SUL-CEP: 95086-200 BRAZIL | | |
| DATE OF REGISTRATION | 30/06/2014 | |
| TITLE | BUS BODY | |
| PRIORITY NA | | |

| | | |
|--|----------------|--|
| DESIGN NUMBER | 257434 |  |
| CLASS | 02-04 | |
| 1)M/S. AERO CLUB, OF THE ADDRESS 867, JOSHI ROAD, KAROL BAGH, NEW DELHI-110005 | | |
| DATE OF REGISTRATION | 11/10/2013 | |
| TITLE | FOOTWEAR | |
| PRIORITY NA | | |
| DESIGN NUMBER | 262777 |  |
| CLASS | 31-00 | |
| 1)PRADEEPKUMAR NANDLAL DHOOT, INDIAN NATIONAL OF GANGAPURWALA, 2275 ADAT BAZAR, AHMEDNAGAR-414001, MAHARASHTRA, INDIA. | | |
| DATE OF REGISTRATION | 21/05/2014 | |
| TITLE | FOOD PROCESSOR | |
| PRIORITY NA | | |
| DESIGN NUMBER | 261271 |  |
| CLASS | 26-05 | |
| 1)MA DESIGN INDIA PRIVATE LIMITED, A COMPANY INCORPORATED IN INDIA HAVING ITS PRINCIPAL PLACE OF BUSINESS AT A-41, SECTOR-80, PHASE-II, NOIDA-201305, U.P. INDIA | | |
| DATE OF REGISTRATION | 27/03/2014 | |
| TITLE | TABLE LAMP | |
| PRIORITY NA | | |

| | | |
|--|-----------------------------------|----------------|
| DESIGN NUMBER | 261405 | |
| CLASS | 13-03 | |
| 1) LARSEN & TOUBRO LIMITED, AN INDIAN COMPANY INCORPORATED UNDER THE COMPANIES ACT, 1956 OF L & T HOUSE, BALLARD ESTATE, MUMBAI 400 001, STATE OF MAHARASHTRA, INDIA | | |
| DATE OF REGISTRATION | 31/03/2014 | |
| TITLE | SWITCH DISCONNECTOR | |
| PRIORITY NA | | |
| DESIGN NUMBER | 261706 | |
| CLASS | 02-04 | |
| 1) COLE HAAN LLC, A CORPORATION ORGANIZED AND EXISTING UNDER THE LAWS OF USA, OF 45 WEST 18TH STREET, THIRD FLOOR, NEW YORK, NY 10011, UNITED STATES OF AMERICA | | |
| DATE OF REGISTRATION | 11/04/2014 | |
| TITLE | SOLE FOR FOOTWEAR | |
| PRIORITY | | |
| PRIORITY NUMBER | DATE | COUNTRY |
| 29/469,730 | 14/10/2013 | U.S.A. |
| DESIGN NUMBER | 261965 | |
| CLASS | 15-09 | |
| 1) SINTOKOGIO, LTD., A JAPANESE COMPANY OF 11-11, NISHIKI 1-CHOME, NAKA-KU, NAGOYA-SHI, AICHI 4600003, JAPAN | | |
| DATE OF REGISTRATION | 23/04/2014 | |
| TITLE | SIDE PLATES FOR SHOTBLAST MACHINE | |
| PRIORITY | | |
| PRIORITY NUMBER | DATE | COUNTRY |
| 2013-028930 | 10/12/2013 | JAPAN |

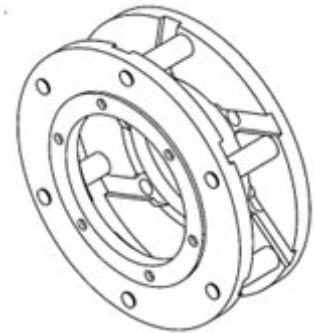
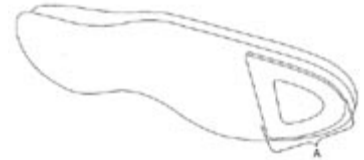
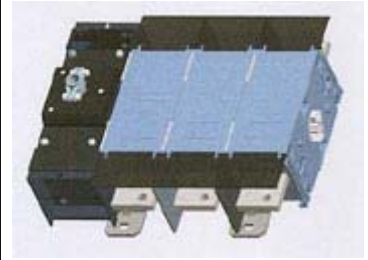

| | | |
|---|---------------------------------|----------------|
| DESIGN NUMBER | 262815 | |
| CLASS | 12-16 | |
| 1)TAFE MOTORS AND TRACTORS LIMITED, COMPANY INCORPORATED UNDER THE COMPANIES ACT, 1956, HAVING ITS REGISTERED OFFICE AT NO. 77, NUNGAMBAKAM HIGH ROAD, POTTIPATTI PLAZA, 1ST FLOOR, CHENNAI-600034, TAMILNADU, INDIA | | |
| DATE OF REGISTRATION | 22/05/2014 | |
| TITLE | BONNET FOR AGRICULTURAL VEHICLE | |
| PRIORITY NA | | |
| DESIGN NUMBER | 259461 | |
| CLASS | 15-09 | |
| 1)IMP TECHNOLOGIES PTY LIMITED, AN AUSTRALIAN PROPRIETARY LIMITED COMPANY HAVING PLACE OF BUSINESS AT SUITE 4E, LEVEL 4, 166 KEIRA STREET, WOLLONGONG NSW 2500, AUSTRALIA | | |
| DATE OF REGISTRATION | 17/01/2014 | |
| TITLE | MILLING DISC | |
| PRIORITY | | |
| PRIORITY NUMBER | DATE | COUNTRY |
| 13470/2013 | 22/07/2013 | AUSTRALIA |
| DESIGN NUMBER | 259832 | |
| CLASS | 06-03 | |
| 1)OK PLAY INDIA LTD. AT PLOT NO. 17-18 ROZ-KA-MEO INDUSTRIAL ESTATE, TEHSIL-NUH, DISTRICT - MEWAT, HARYANA-122103 | | |
| DATE OF REGISTRATION | 29/01/2014 | |
| TITLE | TABLE | |
| PRIORITY NA | | |

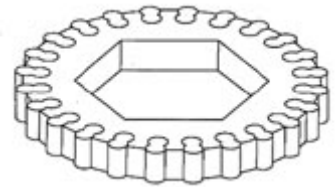

| | |
|---|---------------------------------------|
| DESIGN NUMBER | 260210 |
| CLASS | 24-02 |
| 1)RAHUL GUPTA, AN INDIAN CITIZEN, RESIDING AT HOUSE NO. 83, POCKET H-19, SECTOR-7, ROHINI, DELHI-110085, INDIA | |
| DATE OF REGISTRATION | 07/02/2014 |
| TITLE | TESTING STRIP FOR MEDICAL DIAGNOSTICS |
| PRIORITY NA | |





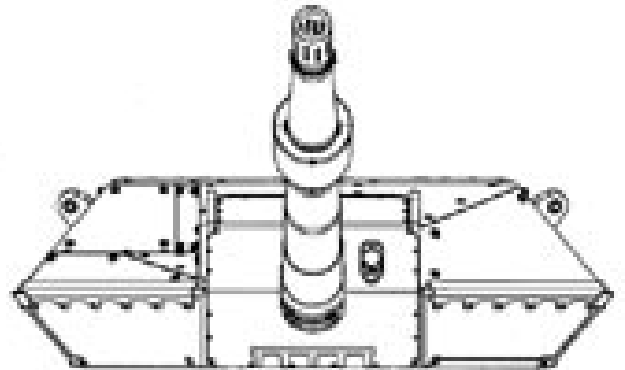

| | | |
|---|------------------------------|----------------|
| DESIGN NUMBER | 259319 | |
| CLASS | 12-13 | |
| 1)OTO MELARA SPA, OF VIA VALDILOCCHI 15, LA SPEZIA, I-19136, ITALY | | |
| DATE OF REGISTRATION | 10/01/2014 | |
| TITLE | TURRET FOR A COMBACT VEHICLE | |
| PRIORITY | | |
| PRIORITY NUMBER | DATE | COUNTRY |
| 002271981 | 10/07/2013 | OHIM |





| | |
|--|------------------|
| DESIGN NUMBER | 263991 |
| CLASS | 02-04 |
| 1)AURA INTERNATIONAL, AN INDIAN PARTNERSHIP FIRM, WHOSE PARTNERS ARE SUMANT KAKARIA, GOURAV CHOPRA AND BRIJ CHOPRA, HAVING ADDRESS AT B-57, PHASE-1, MAYAPURI, INDUSTRIAL AREA, DELHI-110064, INDIA | |
| DATE OF REGISTRATION | 11/07/2014 |
| TITLE | PAIR OF FOOTWEAR |
| PRIORITY NA | |

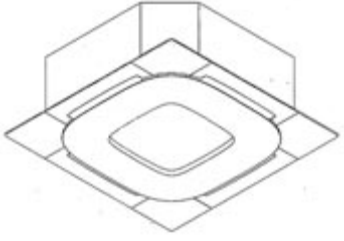
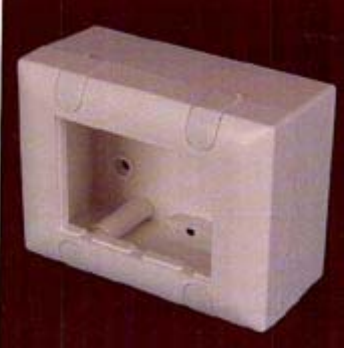

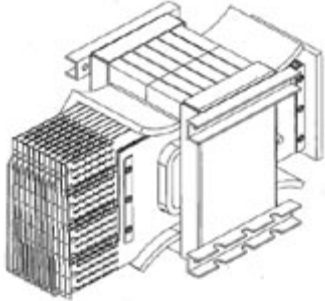

| | | | |
|---|---------------------------------------|----------------|--|
| DESIGN NUMBER | 262812 | |  |
| CLASS | 26-06 | | |
| 1)TAFE MOTORS AND TRACTORS LIMITED, COMPANY INCORPORATED UNDER THE COMPANIES ACT, 1956, HAVING ITS REGISTERED OFFICE AT NO. 77, NUNGAMBAKAM HIGH ROAD, POTTIPATTI PLAZA, 1ST FLOOR, CHENNAI-600034, TAMILNADU, INDIA | | | |
| DATE OF REGISTRATION | 22/05/2014 | | |
| TITLE | FRONT COMBINATION LAMP FOR AUTOMOBILE | | |
| PRIORITY NA | | | |
| DESIGN NUMBER | 259400 | |  |
| CLASS | 25-02 | | |
| 1)MASONITE CORPORATION, ONE TAMPA CITY CENTER, 201 N. FRANKLIN STREET, SUITE 300 TAMPA, FLORIDA 33602, CORPORATION OF DELAWARE | | | |
| DATE OF REGISTRATION | 15/01/2014 | | |
| TITLE | DOOR FACING | | |
| PRIORITY | | | |
| PRIORITY NUMBER | DATE | COUNTRY | |
| 29/460778 | 15/07/2013 | U.S.A. | |
| DESIGN NUMBER | 261356 | |  |
| CLASS | 13-03 | | |
| 1)LARSEN & TOUBRO LIMITED, AN INDIAN COMPANY INCORPORATED UNDER THE COMPANIES ACT, 1956 OF L & T HOUSE, BALLARD ESTATE, MUMBAI 400 001, STATE OF MAHARASHTRA, INDIA | | | |
| DATE OF REGISTRATION | 28/03/2014 | | |
| TITLE | FINAL DISTRIBUTION BOARDS | | |
| PRIORITY NA | | | |

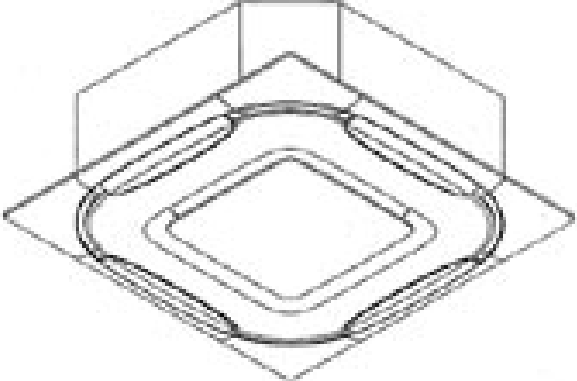

| | | |
|--|--------------------|--|
| DESIGN NUMBER | 263330 |  |
| CLASS | 23-04 | |
| 1)DAIKIN INDUSTRIES LTD., A JAPANESE COMPANY OF THE ADDRESS: UMEDA CENTER BUILDING, 4-12 NAKAZAKI-NISHI 2-CHOME, KITA-KU, OSAKA-SHI, OSAKA-FU, JAPAN | | |
| DATE OF REGISTRATION | 13/06/2014 | |
| TITLE | AIR CONDITIONER | |
| PRIORITY NA | | |
| DESIGN NUMBER | 263495 |  |
| CLASS | 13-03 | |
| 1)SIYAA INDUSTRIES, PARASNATH COMPLEX, PLOT NO. E-7, S. NO. 25, H. NO. 4, OWALI VILLAGE, TALUKA BHIWANDI, DIST. THANE, MAHARASHTRA, INDIA, AN INDIAN PARTNERSHIP FIRM, WHOSE PARTNERS ARE (1) ANIL DAMODAR NARANG (2) SUNIL DAMODAR NARANG, RESIDENT OF NAVJEEVAN SOCIETY, VIJAY NAGAR, OPP: SHIV MANDIR, CHEMBUR WEST, MUMBAI-400074, MAHARASHTRA, INDIA, BOTH OF INDIAN NATIONALITY | | |
| DATE OF REGISTRATION | 19/06/2014 | |
| TITLE | MODULAR SWITCH BOX | |
| PRIORITY NA | | |
| DESIGN NUMBER | 263639 |  |
| CLASS | 12-15 | |
| 1)CHOUDHARY RUBBERS PVT. LTD., VILLAGE-MORTA, OPP.-MANAN DHAM MANDIR, MEERUT ROAD, GHAZIABAD, U.P., (INDIA). (AN INDIAN COMPANY DULY REGISTERED UNDER THE COMPANIES ACT, 1956) | | |
| DATE OF REGISTRATION | 24/06/2014 | |
| TITLE | CYCLE TYRE | |
| PRIORITY NA | | |

| | | |
|---|---------------------------------|--|
| DESIGN NUMBER | 262809 |  |
| CLASS | 12-16 | |
| 1)TAFE MOTORS AND TRACTORS LIMITED, COMPANY INCORPORATED UNDER THE COMPANIES ACT, 1956, HAVING ITS REGISTERED OFFICE AT NO. 77, NUNGAMBAKAM HIGH ROAD, POTTIPATTI PLAZA, 1ST FLOOR, CHENNAI-600034, TAMILNADU, INDIA | | |
| DATE OF REGISTRATION | 22/05/2014 | |
| TITLE | FENDER FOR AGRICULTURAL VEHICLE | |
| PRIORITY NA | | |
| DESIGN NUMBER | 259760 |  |
| CLASS | 13-02 | |
| 1)GENVOLT LIMITED, A COMPANY ORGANIZED UNDER THE LAWS OF UNITED KINGDOM, HAVING THEIR OFFICE AT NEW ROAD, HIGHLEY, BRIDGNORTH, SHROPSHIRE, WV16 6NN, UNITED KINGDOM | | |
| DATE OF REGISTRATION | 28/01/2014 | |
| TITLE | TRANSFORMER | |
| PRIORITY NA | | |
| DESIGN NUMBER | 261716 |  |
| CLASS | 15-03 | |
| 1)KARNAL AGRI IMPEX PVT. LTD., PLOT NO. 262, SECTOR-3, HSIIDC, KARNAL-132001, HARYANA | | |
| DATE OF REGISTRATION | 15/04/2014 | |
| TITLE | HARROW | |
| PRIORITY NA | | |

| | | |
|---|------------|---|
| DESIGN NUMBER | 261924 |  |
| CLASS | 09-01 | |
| 1)MR. SACHIN SACHDEV, MRS. MANASI SACHDEV AND MR. RAVI CHAWLA ALL PARTNERS OF M/S NAYASA MULTIPLAST A PARTNERSHIP CONCERN DULY REGISTERED UNDER THE PARTNERSHIP ACT, 1932 HAVING ADDRESS AT PLOT NOS. 225, 225, 227 AND 228, VILLAGE VELA BATHRI, TAHASIL HAROLI, DISTRICT UNA-732141, HIMACHAL PRADESH | | |
| DATE OF REGISTRATION | 22/04/2014 | |
| TITLE | BOTTLE | |
| PRIORITY NA | | |

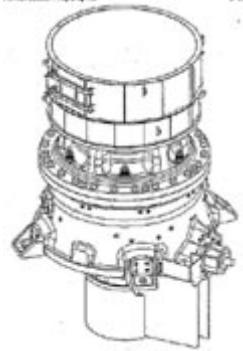

| | | |
|--|-----------------|--|
| DESIGN NUMBER | 263328 |  |
| CLASS | 23-04 | |
| 1)DAIKIN INDUSTRIES LTD., A JAPANESE COMPANY OF THE ADDRESS: UMEDA CENTER BUILDING, 4-12 NAKAZAKI-NISHI 2-CHOME, KITA-KU, OSAKA-SHI, OSAKA-FU, JAPAN | | |
| DATE OF REGISTRATION | 13/06/2014 | |
| TITLE | AIR CONDITIONER | |
| PRIORITY NA | | |

| | | |
|--|--------------------|--|
| DESIGN NUMBER | 263138 |  |
| CLASS | 06-05 | |
| 1)GODREJ & BOYCE MFG. CO. LTD., AN INDIAN COMPANY INCORPORATED UNDER THE COMPANIES ACT, 1913, OF GODREJ INTERIO, PLANT 4, PIROJSHANAGER, VIKHROLI (WEST), MUMBAI-400079, INDIA | | |
| DATE OF REGISTRATION | 05/06/2014 | |
| TITLE | COMBINED WORK DESK | |
| PRIORITY NA | | |

| | | | |
|---|-------------|----------------|--|
| DESIGN NUMBER | 263834 | |  |
| CLASS | 08-07 | | |
| 1)GODREJ & BOYCE MFG. CO. LTD. OF LOCKS DIVISION (PLANT-18), PIROJSHANAGAR, VIKHROLI, MUMBAI - 400079, MAHARASHTRA, INDIA, INDIAN COMPANY | | | |
| DATE OF REGISTRATION | 02/07/2014 | | |
| TITLE | PADLOCK | | |
| PRIORITY NA | | | |
| DESIGN NUMBER | 264777 | |  |
| CLASS | 09-03 | | |
| 1)KELLOGG COMPANY, A DELAWARE CORPORATION, OF ONE KELLOGG SQUARE, PO BOX 3599, BATTLE CREEK, MICHIGAN 49016 USA | | | |
| DATE OF REGISTRATION | 14/08/2014 | | |
| TITLE | CONTAINER | | |
| PRIORITY NA | | | |
| DESIGN NUMBER | 260840 | |  |
| CLASS | 15-99 | | |
| 1)SANDVIK INTELLECTUAL PROPERTY AB OF SE-811 81 SANDVIKEN, SWEDEN, A SWEDISH COMPANY | | | |
| DATE OF REGISTRATION | 07/03/2014 | | |
| TITLE | CRUSHER | | |
| PRIORITY | | | |
| PRIORITY NUMBER | DATE | COUNTRY | |
| 001384291-0001 | 20/09/2013 | OHIM | |

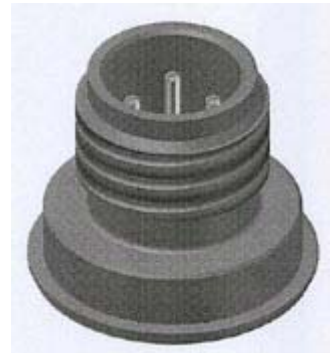
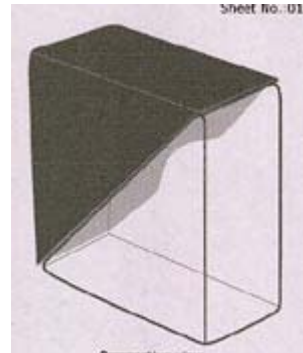
| | | |
|---|---|----------------|
| DESIGN NUMBER | 261922 | |
| CLASS | 09-03 | |
| 1)MR. SACHIN SACHDEV, MRS. MANASI SACHDEV AND MR. RAVI CHAWLA ALL PARTNERS OF M/S NAYASA MULTIPLAST A PARTNERSHIP CONCERN DULY REGISTERED UNDER THE PARTNERSHIP ACT, 1932 HAVING ADDRESS AT PLOT NOS. 225, 225, 227 AND 228, VILLAGE VELA BATHRI, TAHASIL HAROLI, DISTRICT UNA-732141, HIMACHAL PRADESH | | |
| DATE OF REGISTRATION | 22/04/2014 | |
| TITLE | LUNCH BOX | |
| PRIORITY NA | | |
| DESIGN NUMBER | 261181 | |
| CLASS | 09-01 | |
| 1)HORS LIMITED, A COMPANY DULY ORGANIZED AND EXISTING UNDER LAWS OF CYPRUS OF NIKOU PATTICHI, 26, P.C. 3071, LIMASSOL, CYPRUS | | |
| DATE OF REGISTRATION | 21/03/2014 | |
| TITLE | JAR | |
| PRIORITY NA | | |
| DESIGN NUMBER | 261397 | |
| CLASS | 13-03 | |
| 1)DANFOSS A/S, A DANISH COMPANY, OF NORDBORGVEJ 81, DK-6430 NORDBORG, DENMARK | | |
| DATE OF REGISTRATION | 31/03/2014 | |
| TITLE | ELECTRICAL CONNECTOR FOR REFRIGERATION VALVE | |
| PRIORITY | | |
| PRIORITY NUMBER | DATE | COUNTRY |
| 002317677-0001 | 30/09/2013 | OHIM |

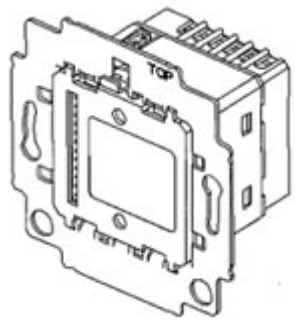







| | | | |
|--|--------------------------------|----------------|--|
| DESIGN NUMBER | 261431 | |  |
| CLASS | 13-99 | | |
| 1)ABB INDIA LIMITED, HAVING REGISTERED OFFICE AT 2ND FLOOR, EAST WING, KHANJJA BHAVAN, 49, RACE COURSE ROAD, BANGALORE 560001, KARNATAKA, INDIA, AN INDIAN COMPANY | | | |
| DATE OF REGISTRATION | 01/04/2014 | | |
| TITLE | SWITCH MODULE | | |
| PRIORITY NA | | | |
| DESIGN NUMBER | 261700 | |  |
| CLASS | 20-02 | | |
| 1)SOREMARTEC S.A., A LUXEMBOURGIAN JOINT STOCK COMPANY OF FINDEL BUSINESS CENTER, COMPLEXE B, RUE DE TREVES, L-2632 FINDEL (LUXEMBOURG) | | | |
| DATE OF REGISTRATION | 11/04/2014 | | |
| TITLE | DEVICE FOR DISPLAY OF ARTICLES | | |
| PRIORITY | | | |
| PRIORITY NUMBER | DATE | COUNTRY | |
| 767596401 | 11/10/2013 | WIPO | |
| DESIGN NUMBER | 263494 | |  |
| CLASS | 13-03 | | |
| 1)SIYAA INDUSTRIES, PARASNATH COMPLEX, PLOT NO. E-7, S. NO. 25, H. NO. 4, OWALI VILLAGE, TALUKA BHIWANDI, DIST. THANE, MAHARASHTRA, INDIA, AN INDIAN PARTNERSHIP FIRM, WHOSE PARTNERS ARE (1) ANIL DAMODAR NARANG (2) SUNIL DAMODAR NARANG, RESIDENT OF NAVJEEVAN SOCIETY, VIJAY NAGAR, OPP: SHIV MANDIR, CHEMBUR WEST, MUMBAI-400074, MAHARASHTRA, INDIA, BOTH OF INDIAN NATIONALITY | | | |
| DATE OF REGISTRATION | 19/06/2014 | | |
| TITLE | MODULAR SWITCH BOX | | |
| PRIORITY NA | | | |



| | | |
|---|--------------|--|
| DESIGN NUMBER | 263142 |  |
| CLASS | 06-05 | |
| 1)GODREJ & BOYCE MFG. CO. LTD., AN INDIAN COMPANY INCORPORATED UNDER THE COMPANIES ACT, 1913, OF GODREJ INTERIO, PLANT 4, PIROJSHANAGER, VIKHROLI (WEST), MUMBAI-400079, INDIA | | |
| DATE OF REGISTRATION | 05/06/2014 | |
| TITLE | MEETING DESK | |
| PRIORITY NA | | |

| | | |
|--|-----------------------|--|
| DESIGN NUMBER | 264131 |  |
| CLASS | 31-00 | |
| 1)BAJAJ ELECTRICALS LIMITED, A COMPANY REGISTERED IN INDIA, HAVING ITS REGISTERED OFFICE AT, 45/47, VEER NARIMAN ROAD, MUMBAI 400023, STATE OF MAHARASHTRA, INDIA, OF ABOVE ADDRESS | | |
| DATE OF REGISTRATION | 18/07/2014 | |
| TITLE | BASE OF MIXER GRINDER | |
| PRIORITY NA | | |

| | | |
|---|------------|--|
| DESIGN NUMBER | 263835 |  |
| CLASS | 12-06 | |
| 1)YUGA DESIGN, NO. 68/13, NEHRU, 4TH STREET, KUMARAN NAGAR, PADI, CHENNAI-600050, INDIA, AN INDIAN COMPANY | | |
| DATE OF REGISTRATION | 02/07/2014 | |
| TITLE | CATAMARAN | |
| PRIORITY NA | | |

| | | |
|---|---------------------------------|--|
| DESIGN NUMBER | 262808 |  |
| CLASS | 12-16 | |
| 1)TAFE MOTORS AND TRACTORS LIMITED, COMPANY INCORPORATED UNDER THE COMPANIES ACT, 1956, HAVING ITS REGISTERED OFFICE AT NO. 77, NUNGAMBAKAM HIGH ROAD, POTTIPATTI PLAZA, 1ST FLOOR, CHENNAI-600034, TAMILNADU, INDIA | | |
| DATE OF REGISTRATION | 22/05/2014 | |
| TITLE | INSTRUMENT PANEL FOR AUTOMOBILE | |
| PRIORITY NA | | |
| DESIGN NUMBER | 260844 |  |
| CLASS | 15-07 | |
| 1)ESBEE ELECTRO-TECH LLP, A LIMITED LIABILITY PARTNERSHIP, AT J-159, M.I.D.C., BHOSARI, PUNE-411 029, MAHARASHTRA, INDIA. | | |
| DATE OF REGISTRATION | 07/03/2014 | |
| TITLE | LIGHTING BULB FOR REFRIGERATOR | |
| PRIORITY NA | | |
| DESIGN NUMBER | 261715 |  |
| CLASS | 15-03 | |
| 1)RAJPAL AGRICULTURAL MACHINERY PVT. LTD. PLOT NO. 182, SECTOR-3, HSIIDC, KARNAL-132001, HARYANA | | |
| DATE OF REGISTRATION | 15/04/2014 | |
| TITLE | PLOUGH | |
| PRIORITY NA | | |

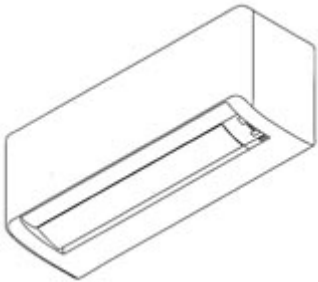
| | | |
|---|---------------------------------------|--|
| DESIGN NUMBER | 259835 |  |
| CLASS | 06-03 | |
| 1)OK PLAY INDIA LTD. AT PLOT NO. 17-18 ROZ-KA-MEO INDUSTRIAL ESTATE, TEHSIL-NUH, DISTRICT - MEWAT, HARYANA-122103 | | |
| DATE OF REGISTRATION | 29/01/2014 | |
| TITLE | CHAIR | |
| PRIORITY NA | | |
| DESIGN NUMBER | 261064 |  |
| CLASS | 07-99 | |
| 1)MA DESIGN INDIA PRIVATE LIMITED, A COMPANY INCORPORATED IN INDIA HAVING ITS PRINCIPAL PLACE OF BUSINESS AT A-41, SECTOR-80, PHASE-II, NOIDA-201305, U.P. INDIA. | | |
| DATE OF REGISTRATION | 19/03/2014 | |
| TITLE | TRAY | |
| PRIORITY NA | | |
| DESIGN NUMBER | 261886 |  |
| CLASS | 13-02 | |
| 1)KARTA PURKH BATTERY INDUSTRIES, 358, FOCAL POINT, AMRITSAR-143001, PUNJAB, INDIA. (AN INDIAN PROPRIETORSHIP FIRM WHOSE PROPRIETOR IS :-SH. GURJEET SINGH. AN INDIAN NATIONAL OF THE ABOVE ADDRESS | | |
| DATE OF REGISTRATION | 21/04/2014 | |
| TITLE | BALL TYPE VALVE FOR USE IN BATTERY | |
| PRIORITY NA | | |

| | | | |
|---|---|----------------|---|
| DESIGN NUMBER | 263332 | |  |
| CLASS | 23-04 | | |
| 1)DAIKIN INDUSTRIES LTD., A JAPANESE COMPANY OF THE ADDRESS: UMEDA CENTER BUILDING, 4-12 NAKAZAKI-NISHI 2-CHOME, KITA-KU, OSAKA-SHI, OSAKA-FU, JAPAN | | | |
| DATE OF REGISTRATION | 13/06/2014 | | |
| TITLE | AIR CONDITIONER | | |
| PRIORITY | | | |
| PRIORITY NUMBER | DATE | COUNTRY |  |
| CN201430024218.1 | 29/01/2014 | CHINA | |
| DESIGN NUMBER | 263990 | | |
| CLASS | 02-04 | | |
| 1)AURA INTERNATIONAL, AN INDIAN PARTNERSHIP FIRM, WHOSE PARTNERS ARE SUMANT KAKARIA, GOURAV CHOPRA AND BRIJ CHOPRA, HAVING ADDRESS AT B-57, PHASE-1, MAYAPURI, INDUSTRIAL AREA, DELHI-110064, INDIA | | | |
| DATE OF REGISTRATION | 11/07/2014 | | |
| TITLE | SOLE FOR FOOTWEAR | | |
| PRIORITY NA | | |  |
| DESIGN NUMBER | 262811 | | |
| CLASS | 26-06 | | |
| 1)TAFE MOTORS AND TRACTORS LIMITED, COMPANY INCORPORATED UNDER THE COMPANIES ACT, 1956, HAVING ITS REGISTERED OFFICE AT NO. 77, NUNGAMBAKAM HIGH ROAD, POTTIPATTI PLAZA, 1ST FLOOR, CHENNAI-600034, TAMILNADU, INDIA | | | |
| DATE OF REGISTRATION | 22/05/2014 | | |
| TITLE | REAR COMBINATION LAMP FOR AUTOMOBILE | | |
| PRIORITY NA | | | |

| | | |
|--|-------------|----------------|
| DESIGN NUMBER | 261327 | |
| CLASS | 14-02 | |
| 1)NOKIA CORPORATION, A FINNISH CORPORATION, OF THE ADDRESS KEILALAHDENTIE 4, ESPOO, FINLAND 02150 | | |
| DATE OF REGISTRATION | 28/03/2014 | |
| TITLE | HANDSET | |
| PRIORITY | | |
| PRIORITY NUMBER | DATE | COUNTRY |
| 29/468846 | 03/10/2013 | U.S.A. |

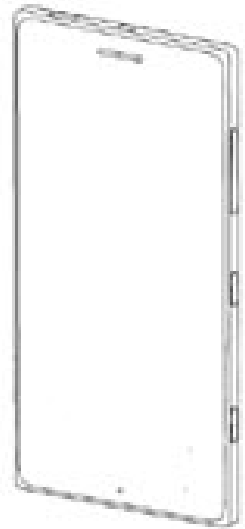

| | | |
|---|-----------------|----------------|
| DESIGN NUMBER | 261513 | |
| CLASS | 31-00 | |
| 1)BUHLER SORTEX LTD A COMPANY INCORPORATED UNDER THE LAWS OF THE UNITED KINGDOM, HAVING ITS REGISTERED OFFICE AT 20 ATLANTIS AVENUE, LONDON, E16 2BF, UNITED KINGDOM | | |
| DATE OF REGISTRATION | 03/04/2014 | |
| TITLE | SORTING MACHINE | |
| PRIORITY | | |
| PRIORITY NUMBER | DATE | COUNTRY |
| 4031953 | 03/10/2013 | U.K. |

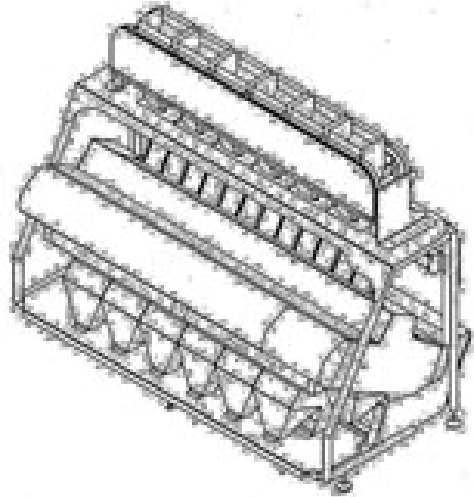

| | | |
|---|--|--|
| DESIGN NUMBER | 262813 | |
| CLASS | 26-06 | |
| 1)TAFE MOTORS AND TRACTORS LIMITED, COMPANY INCORPORATED UNDER THE COMPANIES ACT, 1956, HAVING ITS REGISTERED OFFICE AT NO. 77, NUNGAMBAKAM HIGH ROAD, POTTIPATTI PLAZA, 1ST FLOOR, CHENNAI-600034, TAMILNADU, INDIA | | |
| DATE OF REGISTRATION | 22/05/2014 | |
| TITLE | FRONT COMBINATION LAMP FOR AUTOMOBILE | |
| PRIORITY NA | | |



| | | |
|--|-------------------------------------|--|
| DESIGN NUMBER | 259802 |  |
| CLASS | 23-01 | |
| 1)KETANBHAI KANTIBHAI SOJITRA, INDIAN NATIONAL, HAVING PRINCIPAL PLACE OF BUSINESS AT SURVEY NO. 223/5, PLOT NO. 10, ATULIT INDUSTRIAL AREA, OPP. VIKAS GROUP, NEAR NEW SOMNATH, KOTHARIYA, RAJKOT, GUJARAT, INDIA AND RESIDING AT "SWATI PARK, STREET NO. 3-A, BLOCK NO. C-52, KOTHARIYA, RAJKOT, INDIAN NATIONALS | | |
| DATE OF REGISTRATION | 29/01/2014 | |
| TITLE | PIPE OUTLET USE IN SUBMERSIBLE PUMP | |
| PRIORITY NA | | |
| DESIGN NUMBER | 259195 |  |
| CLASS | 12-16 | |
| 1)M/S STEELBIRD HI-TECH INDIA LIMITED OF B2B/17, JANAK PURI, NEAR METRO PILLAR-540, NEW DELHI- 110058 | | |
| DATE OF REGISTRATION | 03/01/2014 | |
| TITLE | SIDE BOX FOR MOTOR CYCLE | |
| PRIORITY NA | | |
| DESIGN NUMBER | 263833 |  |
| CLASS | 08-07 | |
| 1)GODREJ & BOYCE MFG. CO. LTD. OF LOCKS DIVISION (PLANT-18), PIROJSHANAGAR, VIKHROLI, MUMBAI - 400079, MAHARASHTRA, INDIA, INDIAN COMPANY | | |
| DATE OF REGISTRATION | 02/07/2014 | |
| TITLE | PADLOCK | |
| PRIORITY NA | | |

| | |
|--|------------------------|
| DESIGN NUMBER | 262108 |
| CLASS | 31-00 |
| 1)MR. NIMESH G. CHHEDA, PROPRIETOR-INDIAN NATIONAL, TRADING AS COOKWELL DOMESTIC APPLIANCES, HAVING ITS REGISTERED OFFICE AT 213, SHELAR COMPOUND, SUBHASH NAGAR, VILLAGE ROAD, NAHUR (WEST), BHANDUP, MUMBAI 400078, STATE OF MAHARASHTRA, INDIA, OF ABOVE ADDRESS | |
| DATE OF REGISTRATION | 28/04/2014 |
| TITLE | FLOUR GRINDING MACHINE |
| PRIORITY NA | |



| | | |
|--|-----------------|----------------|
| DESIGN NUMBER | 261919 | |
| CLASS | 07-02 | |
| 1)LA TERMOPLASTIC F.B.M. S.R.L., A COMPANY ORGANIZED UNDER LAW OF THE ITALIAN REPUBLIC OF VIA DEL TORNAGO Z.I.-21010 ARSAGO SEPRIO, (VA), ITALY | | |
| DATE OF REGISTRATION | 22/04/2014 | |
| TITLE | COOKWARE HANDLE | |
| PRIORITY | | |
| PRIORITY NUMBER | DATE | COUNTRY |
| 002334151 | 28/10/2013 | OHIM |

