

INTRODUCTION

In view of the recent amendment made in the Designs (Amendment) Rules, 2008 with effect from 17/06/2008, Publication of the matter relating to Designs is being published in the Official Journal of The Patent Office. This Journal is being published on weekly basis on every Friday covering the various proceedings on Designs as required according to the provisions of under Rule 22, 25, 27 and 39 of the Design (Amendment) Rules, 2008. All the enquiries on this Official Journal and other information as required by the public should be addressed to the Controller General of Patents, Designs & Trade Marks. Suggestions and comments are requested from all quarters so that the content can be enriched.

THE DESIGNS ACT 2000
SECTION 30
DESIGN ASSIGNMENT

The Design stands in the name of **FAYROUZ INTERNATIONAL AG** registered under the Designs Act, 2000 has been assigned in the Register of Designs in the name as follows:-

Design No.	Class	Name
197508	09-01	PREMIUM BEVERAGES INTERNATIONAL B.V., A COMPANY INCORPORATED UNDER THE LAWS OF THE NETHERLANDS, OF TWEEDE WETERINGPLANTSOEN 21, 1017 ZD AMSTERDAM, THE NETHERLANDS

CANCELLATION PROCEEDINGS
under Section 19 of the Designs Act, 2000

(01)

“The Asstt. Controller of Patents & Designs passed an order on 21/10/2014 to dismiss the petition filed by K.P. Laila, Thekkeppallath Peringattuthodi (H), Mecheriparambil, Irumbiliyam Post, Valancheri, Malappuram District, Pin-679572, Kerala State, India, Nationality-Indian on 2/3/2011 for cancellation of registration of registered Design No. 183132 dated 4/8/2000 under class 5 titled as ‘Oval Laminated Artificial Banana Leaf’ in the name of A.R. Safiullah, an Indian, a sole proprietor of and trading as S.A. Safiullah & company, an Indian company, having its principal place of business 9610 Rajagopalapuram, Pudukottai – 622003, Tamil Nadu, India.”

(02)



“The Asstt. Controller of Patents & Designs passed an order on 21/10/2014 to dismiss the petition filed by K.P. Laila, Thekkeppallath Peringattuthodi (H), Mecheriparambil, Irumbiliyam Post, Valancheri, Malappuram District, Pin-679572, Kerala State, India, Nationality-Indian on 2/3/2011 for cancellation of registration of registered Design No. 182931 dated 18/7/2000 under class 5 titled as ‘Laminated Artificial Banana Leaf’ in the name of A.R. Safiullah, a sole proprietor of and trading as S.A. Safiullah & company, having its principal place of business 9610 Rajagopalapuram, Pudukottai – 622003, Tamil Nadu, India.”

COPYRIGHT PUBLICATION

SL NO	REGISTERED DESIGN NUMBERS	RENEWED ON
1.	195748	19.08.2014
2.	195749	19.08.2014
3.	195750	19.08.2014
4.	195751	19.08.2014
5.	197691	19.08.2014
6.	192221	20.08.2014
7.	192223	20.08.2014
8.	192225	20.08.2014
9.	197805	21.08.2014
10.	197806	21.08.2014
11.	190665	04.09.2014
12.	195920	04.09.2014
13.	196781	04.09.2014
14.	215263	10.09.2014
15.	227631	10.09.2014

REGISTRATION OF DESIGNS

The following designs have been registered. They are now open for public inspection. In the following each entry the Date of Registration is shown. The Priority Number, Priority Date and Priority Country are also shown

DESIGN NUMBER	261133		
CLASS	03-04		
1)M/S. ORIENT ELECTRICALS (A DIVISION OF ORIENT PAPER & INDUSTRIES LTD.), 11, INDUSTRIAL ESTATE, SECTOR-6, FARIDABAD, HARYANA-121006			
DATE OF REGISTRATION	20/03/2014		
TITLE	CEILING FAN		
PRIORITY NA			
DESIGN NUMBER	260654		
CLASS	14-01		
1)KONINKLIJKE PHILIPS N.V., A COMPANY ORGANIZED AND EXISTING UNDER THE LAWS OF THE KINGDOM OF THE NETHERLANDS, RESIDING AT EINDHOVEN, WHOSE POST-OFFICE ADDRESS IS HIGH TECH CAMPUS 5, 5656 AE EINDHOVEN, THE NETHERLANDS			
DATE OF REGISTRATION	27/02/2014		
TITLE	HEADPHONE		
PRIORITY			
PRIORITY NUMBER	DATE	COUNTRY	
002298448-0001	28/08/2013	OHIM	
DESIGN NUMBER	260834		
CLASS	25-01		
1)MR. S. S. SRIKANTH S/O. MR. S. R. SATHANANTHAM, AGED 40 YEARS, RESIDING AT OLD NO. 12, NEW NO. 23, GOVINDAPPA STREET, CHENNAI-600001, TAMIL NADU, INDIA			
DATE OF REGISTRATION	07/03/2014		
TITLE	TMT ROD		
PRIORITY NA			

DESIGN NUMBER	259852	
CLASS	07-02	
1)STANDARD BRANDS (UK) LIMITED, A COMPANY ORGANIZED AND EXISTING UNDER THE LAWS OF UNITED KINGDOM, HAVING PLACE OF BUSINESS AT 4, CLEEVE COURT, CLEEVE ROAD, LEATHERHEAD, SURREY, KT22 7SD, UNITED KINGDOM		
DATE OF REGISTRATION	30/01/2014	
TITLE	COOKING STOVE	
PRIORITY		
PRIORITY NUMBER	DATE	COUNTRY
001380810-0004	06/08/2013	OHIM

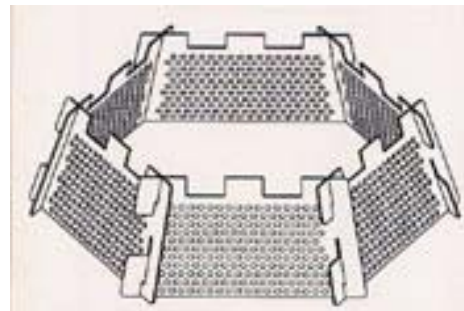

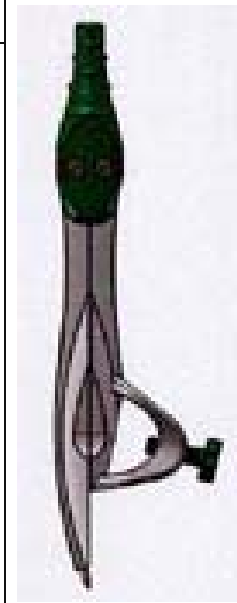

DESIGN NUMBER	260338	
CLASS	19-06	
1)BUDH CHETAN JAYENDRA, NATIONALITY INDIAN, ADDRESS AT SATYAM, 33 KETAN SOCIETY, OPP. MEERA APARTMENT, AMBA VIJAY ESTATE, JAMNAGAR 361008, GUJARAT, INDIA		
DATE OF REGISTRATION	14/02/2014	
TITLE	COMPASS	
PRIORITY NA		





DESIGN NUMBER	261134	
CLASS	03-04	
1)M/S. ORIENT ELECTRICALS (A DIVISION OF ORIENT PAPER & INDUSTRIES LTD.), 11, INDUSTRIAL ESTATE, SECTOR-6, FARIDABAD, HARYANA-121006		
DATE OF REGISTRATION	20/03/2014	
TITLE	CEILING FAN	
PRIORITY NA		



DESIGN NUMBER	257918		
CLASS	06-08		
1)TFS GLOBAL HANGER MANAGEMENT GMBH, A COMPANY UNDER GERMAN LAW OF HOHER WEG 2, 48513 NORDHORN, GERMANY			
DATE OF REGISTRATION	31/10/2013		
TITLE	CLOTHES HANGER		
PRIORITY NA			
DESIGN NUMBER	258566		
CLASS	12-16		
1)MAHINDRA 2 WHEELERS LIMITED, A COMPANY INCORPORATED UNDER THE INDIAN COMPANIES ACT, AT D1 BLOCK, PLOT NO. 18/2 (PART), MIDC, CHINCHWAD, PUNE-411019, MAHARASHTRA, INDIA			
DATE OF REGISTRATION	05/12/2013		
TITLE	TORQUE BOOSTER		
PRIORITY NA			
DESIGN NUMBER	261161		
CLASS	19-06		
1)SATA GMBH & CO. KG, OF DOMERTALSTRASSE 20, 70806 KORNWESTHEIM, DEUTSCHLAND, GERMANY, A GERMAN COMPANY			
DATE OF REGISTRATION	20/03/2014		
TITLE	SPRAY GUN		
PRIORITY			
PRIORITY NUMBER	DATE	COUNTRY	
201330462576.6	27/09/2013	CHINA	



DESIGN NUMBER	261205	
CLASS	02-04	
1)JAI SHREE LAKSHMI POLYMERS, G-943-944, DSIIDC, NARELA INDUSTRIAL AREA, DELHI-110040. (AN INDIAN PROPRIETORSHIP FIRM WHOSE PROPRIETOR IS:- SH. SANDEEP GUPTA. AN INDIAN NATIONAL OF THE ABOVE ADDRESS		
DATE OF REGISTRATION	24/03/2014	
TITLE	FOOTWEAR	
PRIORITY NA		
DESIGN NUMBER	261135	
CLASS	03-04	
1)M/S. ORIENT ELECTRICALS (A DIVISION OF ORIENT PAPER & INDUSTRIES LTD.), 11, INDUSTRIAL ESTATE, SECTOR-6, FARIDABAD, HARYANA-121006		
DATE OF REGISTRATION	20/03/2014	
TITLE	CEILING FAN	
PRIORITY NA		
DESIGN NUMBER	260877	
CLASS	30-03	
1)MA DESIGN INDIA PRIVATE LIMITED, A COMPANY INCORPORATED IN INDIA HAVING ITS PRINCIPAL PLACE OF BUSINESS AT A-41, SECTOR-80, PHASE-II, NOIDA-201305, U.P. INDIA		
DATE OF REGISTRATION	10/03/2014	
TITLE	PET BOWL	
PRIORITY NA		

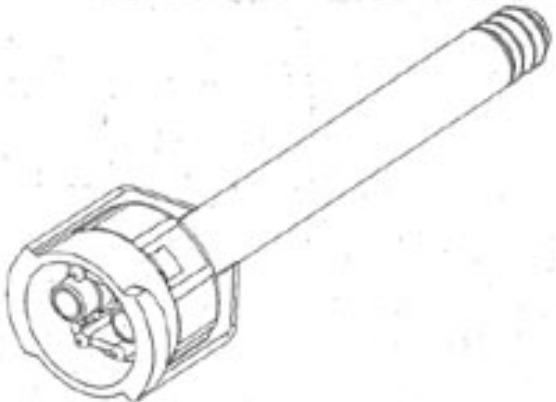

DESIGN NUMBER	257920	
CLASS	06-08	
1)TFS GLOBAL HANGER MANAGEMENT GMBH, A COMPANY UNDER GERMAN LAW OF HOHER WEG 2, 48513 NORDHORN, GERMANY		
DATE OF REGISTRATION	31/10/2013	
TITLE	CLOTHES HANGER	
PRIORITY NA		
DESIGN NUMBER	257376	
CLASS	24-03	
1)DR MANOJ SONI, A-85, G.F. & F.F, MALVIYA NAGAR, NEW DELHI-110017, INDIA, NATIONALITY: INDIAN		
DATE OF REGISTRATION	10/10/2013	
TITLE	ABOVE KNEE PROSTHTIC KIT	
PRIORITY NA		
DESIGN NUMBER	261162	
CLASS	15-06	
1)MR. UPEN D. PATEL AN INDIAN NATIONAL SOLE PROPRIETOR OF ELECTRO PLASTA AN INDIAN PROPRIETORSHIP FIRM HAVING ITS PRINCIPAL PLACE OF BUSINESS AT 206-B, NEW INDUSTRIAL ESTATE, ROAD NO. 6-F, UDYOGNAGAR, UDHNA, SURAT-394210, GUJARAT-INDIA		
DATE OF REGISTRATION	20/03/2014	
TITLE	BOBBIN	
PRIORITY NA		

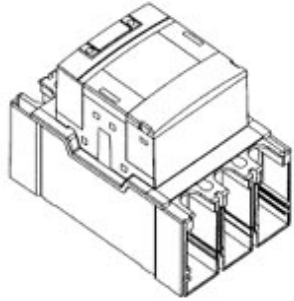

DESIGN NUMBER	258682	
CLASS	24-02	
1)COLTENE/WHALEDENT AG, A SWISS COMPANY OF FELDWIESENSTRASSE 20, 9450 ALTSTAETTEN, SWITZERLAND		
DATE OF REGISTRATION	12/12/2013	
TITLE	STATIC MIXER FOR DENTISTRY	
PRIORITY NA		

DESIGN NUMBER	260197	
CLASS	15-09	
1)JAYENDRABHAI SAGPARIYA AND PIYUSHBHAI SAGPARIYA BOTH INDIAN NATIONAL PARTNERS OF YANTRANG PRECISE AN INDIAN PARTNERSHIP FIRM HAVING ITS PRINCIPAL PLACE OF BUSINESS AT ADDRESS: NH-8B, GONDAL ROAD, OPP. PARIN FURNITURE, INSIDE FROM RAILWAY CROSSING, GOVIND BAG, KOTHARIYA, RAJKOT-360006, GUJARAT-INDIA		
DATE OF REGISTRATION	07/02/2014	
TITLE	COMPUTER NUMERIC CONTROL (CNC) TURNING CENTER	
PRIORITY NA		

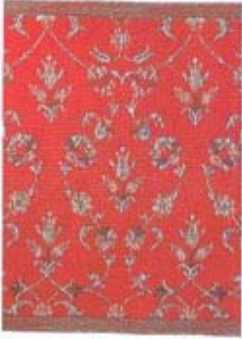
DESIGN NUMBER	260880	
CLASS	07-06	
1)MA DESIGN INDIA PRIVATE LIMITED, A COMPANY INCORPORATED IN INDIA HAVING ITS PRINCIPAL PLACE OF BUSINESS AT A-41, SECTOR-80, PHASE-II, NOIDA-201305, U.P. INDIA		
DATE OF REGISTRATION	10/03/2014	
TITLE	COASTER	
PRIORITY NA		

DESIGN NUMBER	258063		
CLASS	13-03		
1)ABB TECHNOLOGY LTD., AFFOLTERNSTRASSE 44, 8050 ZURICH, SWITZERLAND			
DATE OF REGISTRATION	11/11/2013		
TITLE	LOW VOLTAGE BLOCK CONTACTOR		
PRIORITY			
PRIORITY NUMBER	DATE	COUNTRY	
2013304473656.1	26/09/2013	CHINA	
DESIGN NUMBER	261213		
CLASS	31-00		
1)MR. K. N. SHAJI, INDIAN NATIONALS, PROPRIETOR OF M/S. LAKSHMI MACHINERIES, HAVING OUR OFFICE AT NO. 2/3, GANGA SCHOOL ROAD, NELAGADARANAHALI, NAGASANDRA POST, BANGALORE-560073, KARNATAKA, INDIA			
DATE OF REGISTRATION	25/03/2014		
TITLE	PULVERIZER (MILLING) MACHINE		
PRIORITY NA			
DESIGN NUMBER	259806		
CLASS	12-11		
1)BAJAJ AUTO LIMITED, AN INDIAN COMPANY, INCORPORATED UNDER THE COMPANIES ACT OF 1956, HAVING ITS PRINCIPAL PLACE OF BUSINESS AT NEW 2ND & 3RD FLOOR, KHIVRAJ BUILDING, NO. 616, ANNASALAI, CHENNAI - 600006, STATE OF TAMIL NADU, INDIA, AND REGISTERED OFFICE AT AKURDI, PUNE-411035, STATE OF MAHARASHTRA, INDIA			
DATE OF REGISTRATION	29/01/2014		
TITLE	SHROUD ASSEMBLY FOR MOTORCYCLE		
PRIORITY NA			

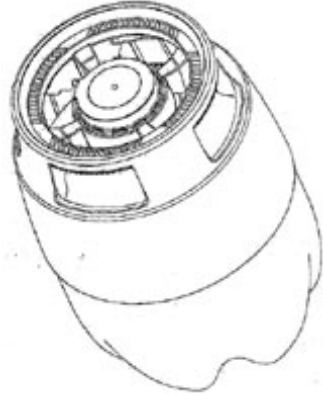

DESIGN NUMBER	250626		
CLASS	12-08		
1)MAN TRUCK & BUS AG, A GERMAN COMPANY OF DACHAUER STR. 667, 80995 MUNICH, GERMANY			
DATE OF REGISTRATION	03/01/2013		
TITLE	DRIVERS CAB OF A UTILITY VEHICLE		
PRIORITY			
PRIORITY NUMBER	DATE	COUNTRY	
001335236	04/07/2012	OHIM	
DESIGN NUMBER	260344		
CLASS	06-11		
1)SAHIL PLASTIC PVT. LTD., A COMPANY INCORPORATED UNDER THE COMPANIES ACT, 1956 WHOSE ADDRESS IS NO. 5 MIRZA STREET, OPPOSITE: ABDULREHMAN STREET, MUMBAI 400003 IN THE STATE OF MAHARASHTRA WITHIN THE UNION OF INDIA, WHO ARE INDIAN BY NATIONALITY			
DATE OF REGISTRATION	14/02/2014		
TITLE	MAT		
PRIORITY NA			
DESIGN NUMBER	260937		
CLASS	07-03		
1)MUDITA MULL, OF MULL BUILDINGS, 4, ASHOK MARG, LUCKNOW-226001, INDIA, AN INDIAN CITIZEN			
DATE OF REGISTRATION	12/03/2014		
TITLE	SPOON SET		
PRIORITY NA			

DESIGN NUMBER	261021		
CLASS	08-07		
1)SH. RAJNEESH GODANI, PROPRIETOR M/S GODANI METAL CO., B-14, INDUSTRIAL ESTATE, ALIGARH-202001 (UTTAR PRADESH) (INDIAN NATIONAL)			
DATE OF REGISTRATION	18/03/2014		
TITLE	DOOR BOLT		
PRIORITY NA			
DESIGN NUMBER	261141		
CLASS	12-11		
1)BAJAJ AUTO LIMITED, AN INDIAN COMPANY, INCORPORATED UNDER THE COMPANIES ACT OF 1956, HAVING ITS PRINCIPAL PLACE OF BUSINESS AT NEW 2ND & 3RD FLOOR, KHIVRAJ BUILDING, NO. 616, ANNASALAI, CHENNAI - 600006, STATE OF TAMIL NADU, INDIA, AND REGISTERED OFFICE AT AKURDI, PUNE-411035, STATE OF MAHARASHTRA, INDIA			
DATE OF REGISTRATION	20/03/2014		
TITLE	WINDSHIELD FOR MOTORCYCLE		
PRIORITY NA			
DESIGN NUMBER	260050		
CLASS	09-02		
1)PET ENGINEERING & SERVICES S.R.L. OF VIA MARTIN LUTHER KING. 20, 24050 GRASSOBBIO (BERGAMO), ITALY, AN ITALIAN COMPANY			
DATE OF REGISTRATION	03/02/2014		
TITLE	BARREL		
PRIORITY			
PRIORITY NUMBER	DATE	COUNTRY	
002286450-0002	05/08/2013	OHIM	



DESIGN NUMBER	260845	
CLASS	12-11	
1)SANYANG INDUSTRY CO., LTD., A COMPANY ORGANIZED AND EXISTING UNDER THE LAWS OF TAIWAN, REPUBLIC OF CHINA WHO ARE TAIWANESE BY NATIONALITY AND WHOSE ADDRESS IS NO. 184, KENG TZU KOU, SHANG KENG VILLAGE, HSIN FONG SHIANG, HSINCHU, COUNTY 304, TAIWAN, REPUBLIC OF CHINA		
DATE OF REGISTRATION	07/03/2014	
TITLE	MOTORCYCLE	
PRIORITY NA		

DESIGN NUMBER	260882	
CLASS	07-03	
1)MA DESIGN INDIA PRIVATE LIMITED, A COMPANY INCORPORATED IN INDIA HAVING ITS PRINCIPAL PLACE OF BUSINESS AT A-41, SECTOR-80, PHASE-II, NOIDA-201305, U.P. INDIA		
DATE OF REGISTRATION	10/03/2014	
TITLE	CHEESE KNIFE	
PRIORITY NA		

DESIGN NUMBER	259475		
CLASS	13-03		
1)SCHURTER AG A SWISS COMPANY OF WERKHOFSTRASSE 8-12, 6002 LUZERN SWITZERLAND			
DATE OF REGISTRATION	17/01/2014		
TITLE	ELECTRIC DEVICE PLUG		
PRIORITY			
PRIORITY NUMBER	DATE	COUNTRY	
140051	18/07/2013	SWITZERLAND	

DESIGN NUMBER	258235		
CLASS	13-03		
1)ROSEMOUNT INC., A CORPORATION ORGANIZED AND EXISTING UNDER THE LAWS OF THE STATE OF MINNESOTA OF 8200 MARKET BOULEVARD, CHANHASSEN, MINNESOTA 55317, UNITED STATES OF AMERICA; NATIONALITY: U.S.A.			
DATE OF REGISTRATION	19/11/2013		
TITLE	HOUSING FOR PROCESS TRANSMITTER		
PRIORITY			
PRIORITY NUMBER	DATE	COUNTRY	
29/459,539	01/07/2013	U.S.A.	
DESIGN NUMBER	261167		
CLASS	09-01		
1)SARAIWWALAA AGRR REFINERIES LIMITED, (INCORPORATED AND REGISTERED UNDER THE INDIAN COMPANIES ACT, 1956), HAVING ITS REGISTERED OFFICE AT PLOT NO. 268, SRI KRUPA MARKET, MAHBOOB MANSION, MALAKPET, HYDERABAD-500036, A.P.			
DATE OF REGISTRATION	21/03/2014		
TITLE	BOTTLE		
PRIORITY NA			
DESIGN NUMBER	261216		
CLASS	09-01		
1)MOUNT EVEREST MINERAL WATER LIMITED, AN INDIAN COMPANY OF, DHAULA KUAN, PAONTA SAHIB, DISTRICT SIRMOUR-173025, HIMACHAL PRADESH, INDIA			
DATE OF REGISTRATION	25/03/2014		
TITLE	BOTTLE		
PRIORITY NA			



DESIGN NUMBER	261328	
CLASS	15-07	
1)PRADEEPKUMAR NANDLAL DHOOT, INDIAN NATIONAL OF GANGAPURWALA, 2275 ADAT BAZAR, AHMEDNAGAR-414001, MAHARASHTRA, INDIA		
DATE OF REGISTRATION	28/03/2014	
TITLE	BASE FOR REFRIGERATOR	
PRIORITY NA		
DESIGN NUMBER	259751	
CLASS	12-16	
1)HERO MOTOCORP LIMITED, AN INDIAN COMPANY INCORPORATED UNDER THE COMPANIES ACT, HAVING ITS OFFICE AT 34, COMMUNITY CENTRE, BASANT LOK, VASANT VIHAR, NEW DELHI-110057		
DATE OF REGISTRATION	28/01/2014	
TITLE	COWL FOR A TWO WHEELED VEHICLE	
PRIORITY NA		
DESIGN NUMBER	259809	
CLASS	26-06	
1)BAJAJ AUTO LIMITED, AN INDIAN COMPANY, INCORPORATED UNDER THE COMPANIES ACT OF 1956, HAVING ITS PRINCIPAL PLACE OF BUSINESS AT NEW 2ND & 3RD FLOOR, KHIVRAJ BUILDING, NO. 616, ANNASALAI, CHENNAI - 600006, STATE OF TAMIL NADU, INDIA, AND REGISTERED OFFICE AT AKURDI, PUNE-411035, STATE OF MAHARASHTRA, INDIA		
DATE OF REGISTRATION	29/01/2014	
TITLE	TAIL LAMP SET FOR MOTORCYCLE	
PRIORITY NA		

DESIGN NUMBER	260343	
CLASS	06-11	
1)SAHIL PLASTIC PVT. LTD., A COMPANY INCORPORATED UNDER THE COMPANIES ACT, 1956 WHOSE ADDRESS IS NO. 5 MIRZA STREET, OPPOSITE: ABDULREHMAN STREET, MUMBAI 400003 IN THE STATE OF MAHARASHTRA WITHIN THE UNION OF INDIA, WHO ARE INDIAN BY NATIONALITY		
DATE OF REGISTRATION	14/02/2014	
TITLE	MAT	
PRIORITY NA		
DESIGN NUMBER	260047	
CLASS	08-06	
1)JAYESHBHAI G. SARDHARA AN INDIAN NATIONAL SOLE PROPRIETOR OF MAHARAJA TECHNOCAST AN INDIAN PROPRIETORSHIP FIRM HAVING ITS PRINCIPAL PLACE OF BUSINESS AT: 4, PARSANA SOCIETY, 50 FEET MAIN ROAD, 80 FEET ROAD, RAJKOT-2, GUJARAT-INDIA		
DATE OF REGISTRATION	03/02/2014	
TITLE	HANDLE	
PRIORITY NA		
DESIGN NUMBER	261905	
CLASS	08-06	
1)HARSHADBHAI KARSANBHAI AJANI (ADULT & INDIAN NATIONAL) SOLE PROPRIETOR OF PAL ENTERPRISE (INDIAN PROPRIETORSHIP CONCERN) HAVING PLACE OF BUSINESS AT: 6, PARSANA SOCIETY, 50 FEET ROAD, KOTHARIA ROAD, RAJKOT-GUJARAT-(INDIA)		
DATE OF REGISTRATION	22/04/2014	
TITLE	HANDLE	
PRIORITY NA		

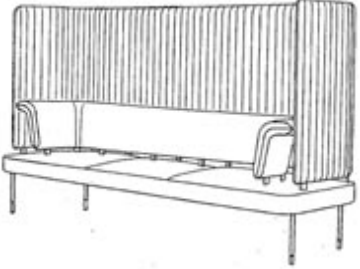

DESIGN NUMBER	260881	
CLASS	07-03	
1)MA DESIGN INDIA PRIVATE LIMITED, A COMPANY INCORPORATED IN INDIA HAVING ITS PRINCIPAL PLACE OF BUSINESS AT A-41, SECTOR-80, PHASE-II, NOIDA-201305, U.P. INDIA		
DATE OF REGISTRATION	10/03/2014	
TITLE	CHEESE SPREADER	
PRIORITY NA		

DESIGN NUMBER	258220	
CLASS	12-05	
1)PERFECT TECHNOLOGY, REGISTERED PARTNERSHIP FIRM, HAVING PARTNERS 1. MR. IMTIYAZBHAI ISMAILSHA FAKIR 2. MR. SABIRBHAI ISMAILSHA FAKIR 3. MR. IMRANBHAI IKBALBHAI SHAHAMDAR, HAVING REGISTERED OFFICE IS PLOT NO. 192, KUVADAVA G.I.D.C., RAJKOT-AHMEDABAD HIGHWAY, AT. KUVADAVA, DIST. RAJKOT, GUJARAT		
DATE OF REGISTRATION	19/11/2013	
TITLE	BUCKET ELEVATOR	
PRIORITY NA		

DESIGN NUMBER	259109	
CLASS	06-03	
1)THE SUPREME INDUSTRIES LTD., (AN INDIAN PUBLIC LIMITED COMPANY), 601 CENTRAL PLAZA, 2/6, SARAT BOSE ROAD, KOLKATA - 700020, WEST BENGAL, INDIA		
DATE OF REGISTRATION	30/12/2013	
TITLE	TABLE	
PRIORITY NA		

DESIGN NUMBER	258578		
CLASS	06-01		
1)HERMAN MILLER, INC., A CORPORATION ORGANIZED AND EXISTING UNDER THE LAWS OF THE STATE OF MICHIGAN, UNITED STATES OF AMERICA, OF 855 EAST MAIN AVENUE, ZEELAND, MICHIGAN 49464, UNITED STATES OF AMERICA			
DATE OF REGISTRATION	05/12/2013		
TITLE	COUCH		
PRIORITY			
PRIORITY NUMBER	DATE	COUNTRY	
29/457,273	07/06/2013	U.S.A.	
DESIGN NUMBER	261215		
CLASS	26-06		
1)MINDA INDUSTRIES LIMITED., AN INDIAN COMPANY OF VILL. NAWADA FATEPUR, P.O. SIKANDERPUR BADDA, MANESAR, DISTT. GURGAON, HARYANA-122004, INDIA			
DATE OF REGISTRATION	25/03/2014		
TITLE	FOG LAMP FOR VEHICLE		
PRIORITY NA			
DESIGN NUMBER	259750		
CLASS	12-16		
1)HERO MOTOCORP LIMITED, AN INDIAN COMPANY INCORPORATED UNDER THE COMPANIES ACT, HAVING ITS OFFICE AT 34, COMMUNITY CENTRE, BASANT LOK, VASANT VIHAR, NEW DELHI-110057			
DATE OF REGISTRATION	28/01/2014		
TITLE	FRONT COWL FOR A TWO WHEELED VEHICLE		
PRIORITY NA			

DESIGN NUMBER	259808		
CLASS	12-11		
1)BAJAJ AUTO LIMITED, AN INDIAN COMPANY, INCORPORATED UNDER THE COMPANIES ACT OF 1956, HAVING ITS PRINCIPAL PLACE OF BUSINESS AT NEW 2ND & 3RD FLOOR, KHIVRAJ BUILDING, NO. 616, ANNASALAI, CHENNAI - 600006, STATE OF TAMIL NADU, INDIA, AND REGISTERED OFFICE AT AKURDI, PUNE-411035, STATE OF MAHARASHTRA, INDIA			
DATE OF REGISTRATION	29/01/2014		
TITLE	SWING ARM ASSEMBLY FOR MOTORCYCLE		
PRIORITY NA			
DESIGN NUMBER	260196		
CLASS	15-09		
1)JAYENDRABHAI SAGPARIYA AND PIYUSHBHAI SAGPARIYA BOTH INDIAN NATIONAL PARTNERS OF YANTRANG PRECISE AN INDIAN PARTNERSHIP FIRM HAVING ITS PRINCIPAL PLACE OF BUSINESS AT ADDRESS: NH-8B, GONDAL ROAD, OPP. PARIN FURNITURE, INSIDE FROM RAILWAY CROSSING, GOVIND BAG, KOTHARIYA, RAJKOT-360006, GUJARAT-INDIA			
DATE OF REGISTRATION	07/02/2014		
TITLE	COMPUTER NUMERIC CONTROL (CNC) TURNING CENTER		
PRIORITY NA			
DESIGN NUMBER	260248		
CLASS	12-08		
1)BAYERISCHE MOTOREN WERKE AKTIENGESELLSCHAFT, OF PETUELRING 130, 80809, MUENCHEN, GERMANY, A GERMAN COMPANY			
DATE OF REGISTRATION	10/02/2014		
TITLE	CAR		
PRIORITY			
PRIORITY NUMBER	DATE	COUNTRY	
EM 002291914-0001	14/08/2013	EUROPEAN UNION	



DESIGN NUMBER	261138	
CLASS	12-11	
1)BAJAJ AUTO LIMITED, AN INDIAN COMPANY, INCORPORATED UNDER THE COMPANIES ACT OF 1956, HAVING ITS PRINCIPAL PLACE OF BUSINESS AT NEW 2ND & 3RD FLOOR, KHIVRAJ BUILDING, NO. 616, ANNASALAI, CHENNAI - 600006, STATE OF TAMIL NADU, INDIA, AND REGISTERED OFFICE AT AKURDI, PUNE-411035, STATE OF MAHARASHTRA, INDIA		
DATE OF REGISTRATION	20/03/2014	
TITLE	SPEEDOMETER ASSEMBLY FOR MOTORCYCLE	
PRIORITY NA		
DESIGN NUMBER	256796	
CLASS	12-05	
1)M/S. KUMBHOJKAR PLASTIC MOULDERS, A REGISTERED PARTNERSHIP FIRM WHOSE PARTNERS ARE 1) ARUN SHAMRAO KUMBHOJKAR AND 2) ANAND ARUN KUMBHOJKAR, BOTH RESIDING AT 425/3, SHARAD CHNADRA, FLAT 1, TMV COLONY, MUKUND NAGAR ROAD, PUNE 411037 MAHARASHTRA, INDIA AND HAVING OFFICE AT 129, NARAYAN PETH, SITAPHAL BAUG COLONY, NEAR MATI GANAPATI, PUNE 411030 MAHARASHTRA, INDIA		
DATE OF REGISTRATION	26/09/2013	
TITLE	CABLE CARRIER FOR CRANES	
PRIORITY NA		
DESIGN NUMBER	260879	
CLASS	26-01	
1)MA DESIGN INDIA PRIVATE LIMITED, A COMPANY INCORPORATED IN INDIA HAVING ITS PRINCIPAL PLACE OF BUSINESS AT A-41, SECTOR-80, PHASE-II, NOIDA-201305, U.P. INDIA		
DATE OF REGISTRATION	10/03/2014	
TITLE	CANDLE HOLDER	
PRIORITY NA		

DESIGN NUMBER	260622	
CLASS	99-00	
1)SUNIL P.P. (INDIAN) RESIDING AT: PALLIYIL HOUSE, ANAKKAD ROAD, KANJANI, P.O., THRISSUR-680612, KERALA, INDIA		
DATE OF REGISTRATION	26/02/2014	
TITLE	BIOGAS PLANT	
PRIORITY NA		

DESIGN NUMBER	255641	
CLASS	09-05	
1)SOCIÉTÉ DES PRODUITS NESTLÉ S.A. A COMPANY INCORPORATED UNDER THE LAWS OF THE SWITZERLAND HAVING ITS REGISTERED OFFICE AT 1800 VEVEY, SWITZERLAND		
DATE OF REGISTRATION	05/08/2013	
TITLE	CAPSULE FOR BEVERAGE DISPENSER	
PRIORITY		
PRIORITY NUMBER	DATE	COUNTRY
139551	07/02/2013	SWITZERLAND

DESIGN NUMBER	260850	
CLASS	12-16	
1)MITRAS BIKES PRIVATE LIMITED, 308, SUNEHRI BAGH APARTMENTS, SECTOR 13, ROHINI, DELHI 110085, DELHI STATE, INDIA, A PRIVATE LIMITED COMPANY INCORPORATED UNDER THE INDIAN COMPANIES ACT, 1956		
DATE OF REGISTRATION	10/03/2014	
TITLE	SEAT FOR CYCLES, BICYCLES AND TRICYCLES	
PRIORITY NA		

DESIGN NUMBER	260884	
CLASS	07-01	
1)MA DESIGN INDIA PRIVATE LIMITED, A COMPANY INCORPORATED IN INDIA HAVING ITS PRINCIPAL PLACE OF BUSINESS AT A-41, SECTOR-80, PHASE-II, NOIDA-201305, U.P. INDIA		
DATE OF REGISTRATION	10/03/2014	
TITLE	CUP	
PRIORITY NA		
DESIGN NUMBER	261330	
CLASS	15-07	
1)PRADEEPKUMAR NANDLAL DHOOT, INDIAN NATIONAL OF GANGAPURWALA, 2275 ADAT BAZAR, AHMEDNAGAR-414001, MAHARASHTRA, INDIA		
DATE OF REGISTRATION	28/03/2014	
TITLE	LEFT DRAWER BASESTAND FOR REFRIGERATOR	
PRIORITY NA		
DESIGN NUMBER	261593	
CLASS	08-06	
1)M/S MARS INDUSTRIES PVT. LTD., (A COMPANY INCORPORATED UNDER INDIAN COMPANIES ACT) A-88 ROAD NO. 2, MAHIPALPUR EXTN., NEW DELHI-110037, (INDIA)		
DATE OF REGISTRATION	09/04/2014	
TITLE	HANDLE SET	
PRIORITY NA		

DESIGN NUMBER	259822	
CLASS	10-04	
1)BAJAJ AUTO LIMITED, AN INDIAN COMPANY, INCORPORATED UNDER THE COMPANIES ACT OF 1956, HAVING ITS PRINCIPAL PLACE OF BUSINESS AT NEW 2ND & 3RD FLOOR, KHIVRAJ BUILDING, NO. 616, ANNASALAI, CHENNAI - 600006, STATE OF TAMIL NADU, INDIA, AND REGISTERED OFFICE AT AKURDI, PUNE-411035, STATE OF MAHARASHTRA, INDIA		
DATE OF REGISTRATION	29/01/2014	
TITLE	SPEEDOMETER ASSEMBLY FOR MOTORCYCLE	
PRIORITY NA		
DESIGN NUMBER	260657	
CLASS	13-01	
1)ENDICO POWER TOOLS, AN INDIAN COMPANY, OF 1276/1, ST NO. 3, SHIMLAPURI, LUDHIANA-141003, PUNJAB, INDIA		
DATE OF REGISTRATION	27/02/2014	
TITLE	FAN OF ARMATURE	
PRIORITY NA		
DESIGN NUMBER	259494	
CLASS	11-02	
1)AMAR SINGH YADAV, TRADING AS M/S. S. N. GLASS DECORATERS, SITUATED AT 2/778, SUHAG NAGAR, FIROZABAD (U.P.) INDIA, OF ABOVE ADDRESS		
DATE OF REGISTRATION	20/01/2014	
TITLE	FLOWER VASE	
PRIORITY NA		



DESIGN NUMBER	257833		
CLASS	15-03		
1)STANDARD CORPORATION INDIA LIMITED, OF STANDARD CHOWK, BARNALA, PUNJUB, INDIA, A COMPANY INCORPORATED UNDER THE COMPANIES ACT, 1956, OF THE ABOVE ADDRESS			
DATE OF REGISTRATION	29/10/2013		
TITLE	CROP CUTTING BALER		
PRIORITY NA			
DESIGN NUMBER	258364		
CLASS	12-16		
1)DAIMLER INDIA COMMERCIAL VEHICLES PRIVATE LIMITED, AN INDIAN COMPANY INCORPORATED UNDER THE LAWS OF INDIA, OF UNIT 201, 2ND FLOOR CAMPUS 3B, RMZ MILLENNIA BUSINESS PARK NO. 143, DR. MGR ROAD, PERUNGUDI, CHENNAI-600096, INDIA			
DATE OF REGISTRATION	25/11/2013		
TITLE	FENDER FOR VEHICLES		
PRIORITY			
PRIORITY NUMBER	DATE	COUNTRY	
002244459-0007	27/05/2013	OHIM	
DESIGN NUMBER	261288		
CLASS	08-06		
1)(1) KASHYAP A. PATEL (2) SANDIP S. GHONIYA (3) VINAYBHAI M. PATEL (4) PARESH D. RAIYANI ALL INDIAN NATIONAL PARTNERS OF YAKSH SALES CORPORATION AN INDIAN PARTNERSHIP FIRM HAVING ITS PRINCIPAL PLACE OF BUSINESS AT SANSKAR SOCIETY, STREET NO. 1, PLOT NO. 28, NEAR BALAJI INDUSTRIES, AJI RING ROAD, RAJKOT, GUJARAT-INDIA			
DATE OF REGISTRATION	27/03/2014		
TITLE	HANDLE		
PRIORITY NA			

DESIGN NUMBER	259826	
CLASS	12-11	
1)BAJAJ AUTO LIMITED, AN INDIAN COMPANY, INCORPORATED UNDER THE COMPANIES ACT OF 1956, HAVING ITS PRINCIPAL PLACE OF BUSINESS AT NEW 2ND & 3RD FLOOR, KHIVRAJ BUILDING, NO. 616, ANNASALAI, CHENNAI - 600006, STATE OF TAMIL NADU, INDIA, AND REGISTERED OFFICE AT AKURDI, PUNE-411035, STATE OF MAHARASHTRA, INDIA		
DATE OF REGISTRATION	29/01/2014	
TITLE	MOTORCYCLE	
PRIORITY NA		

DESIGN NUMBER	261022	
CLASS	08-07	
1)SH. RAJNEESH GODANI, PROPRIETOR M/S GODANI METAL CO., B-14, INDUSTRIAL ESTATE, ALIGARH-202001 (UTTAR PRADESH) (INDIAN NATIONAL)		
DATE OF REGISTRATION	18/03/2014	
TITLE	DOOR BOLT	
PRIORITY NA		

DESIGN NUMBER	261920		
CLASS	04-02		
1)EBNAT AG, A SWISS COMPANY OF INDUSTRIESTRASSE 34, 9642 EBNAT-KAPPEL, SWITZERLAND			
DATE OF REGISTRATION	22/04/2014		
TITLE	TOOTHBRUSH		
PRIORITY			
PRIORITY NUMBER	DATE	COUNTRY	
770206201	24/10/2013	WIPO	

DESIGN NUMBER	260771	
CLASS	13-03	
1)M/S V-GUARD INDUSTRIES LTD., AN INDIAN COMPANY INCORPORATED UNDER THE COMPANIES ACT OF 1956 WHOSE ADDRESS IS 33/2905 F, VENNALA HIGH SCHOOL ROAD, VENNALA, KOCHI-682028, KERALA STATE, INDIA		
DATE OF REGISTRATION	04/03/2014	
TITLE	STABILIZERS	
PRIORITY NA		
DESIGN NUMBER	260849	
CLASS	12-16	
1)MITRAS BIKES PRIVATE LIMITED, 308, SUNEHRI BAGH APARTMENTS, SECTOR 13, ROHINI, DELHI 110085, DELHI STATE, INDIA, A PRIVATE LIMITED COMPANY INCORPORATED UNDER THE INDIAN COMPANIES ACT, 1956		
DATE OF REGISTRATION	10/03/2014	
TITLE	SEAT FOR CYCLES, BICYCLES AND TRICYCLES	
PRIORITY NA		
DESIGN NUMBER	260883	
CLASS	07-03	
1)MA DESIGN INDIA PRIVATE LIMITED, A COMPANY INCORPORATED IN INDIA HAVING ITS PRINCIPAL PLACE OF BUSINESS AT A-41, SECTOR-80, PHASE-II, NOIDA-201305, U.P. INDIA		
DATE OF REGISTRATION	10/03/2014	
TITLE	CHEESE KNIFE	
PRIORITY NA		

DESIGN NUMBER	259587		
CLASS	24-01		
1)SEKISUI MEDICAL CO., LTD., A JAPANESE CORPORATION, OF 13-5, NIHONBASHI 3-CHOME, CHOU-KU, TOKYO, JAPAN			
DATE OF REGISTRATION	23/01/2014		
TITLE	LIQUID CHROMATOGRAPH		
PRIORITY			
PRIORITY NUMBER	DATE	COUNTRY	
2013-017073	26/07/2013	JAPAN	
DESIGN NUMBER	259244		
CLASS	12-16		
1)BAJAJ AUTO LIMITED, AN INDIAN COMPANY, INCORPORATED UNDER THE COMPANIES ACT OF 1956, HAVING ITS PRINCIPAL PLACE OF BUSINESS AT NEW 2ND & 3RD FLOOR, KHIVRAJ BUILDING, NO. 616, ANNASALAI, CHENNAI - 600006, STATE OF TAMIL NADU, INDIA, AND REGISTERED OFFICE AT AKURDI, PUNE-411035, STATE OF MAHARASHTRA, INDIA			
DATE OF REGISTRATION	06/01/2014		
TITLE	WHEEL RIM FOR VEHICLE		
PRIORITY NA			
DESIGN NUMBER	261329		
CLASS	15-07		
1)PRADEEPKUMAR NANDLAL DHOOT, INDIAN NATIONAL OF GANGAPURWALA, 2275 ADAT BAZAR, AHMEDNAGAR-414001, MAHARASHTRA, INDIA			
DATE OF REGISTRATION	28/03/2014		
TITLE	RIGHT DRAWER BASESTAND FOR REFRIGERATOR		
PRIORITY NA			

DESIGN NUMBER	256251		
CLASS	20-03		
1)M/S. MAHINDRA REVA ELECTRIC VEHICLES PRIVATE LIMITED, HAVING ITS PLACE OF BUSINESS AT NO. 122 E, BOMMASANDRA INDUSTRIAL ESTATE, OFF HOSUR ROAD, BANGALORE-560099, KARNATAKA, INDIA			
DATE OF REGISTRATION	06/09/2013		
TITLE	DISPLAY BOARD FOR ELECTRIC VEHICLE CHARGING POINT		
PRIORITY NA			
DESIGN NUMBER	259815		
CLASS	26-06		
1)BAJAJ AUTO LIMITED, AN INDIAN COMPANY, INCORPORATED UNDER THE COMPANIES ACT OF 1956, HAVING ITS PRINCIPAL PLACE OF BUSINESS AT NEW 2ND & 3RD FLOOR, KHIVRAJ BUILDING, NO. 616, ANNASALAI, CHENNAI - 600006, STATE OF TAMIL NADU, INDIA, AND REGISTERED OFFICE AT AKURDI, PUNE-411035, STATE OF MAHARASHTRA, INDIA			
DATE OF REGISTRATION	29/01/2014		
TITLE	HEAD LAMP FOR MOTORCYCLE		
PRIORITY NA			
DESIGN NUMBER	258703		
CLASS	09-01		
1)S.C. JOHNSON & SON, INC., A CORPORATION ORGANIZED AND EXISTING UNDER THE LAWS OF THE STATE OF WISCONSIN, UNITED STATES OF AMERICA WHO ARE AMERICAN BY NATIONALITY AND WHOSE ADDRESS IS 1525 HOWE STREET, RACINE, WISCONSIN 53403-2236, UNITED STATES OF AMERICA			
DATE OF REGISTRATION	12/12/2013		
TITLE	DISPENSER WITH CAP		
PRIORITY			
PRIORITY NUMBER	DATE	COUNTRY	
29/458,189	17/06/2013	U.S.A.	

DESIGN NUMBER	261026
CLASS	12-16
1)TATA MOTORS LIMITED, AN INDIAN COMPANY OF BOMBAY HOUSE, 24 HOMI MODY STREET, HUTATMA CHOWK, MUMBAI 400001, MAHARASHTRA, INDIA	
DATE OF REGISTRATION	18/03/2014
TITLE	BRACKET FOR MOUNTING REMOTE KEYLESS ENTRY CONTROLLER OF A VEHICLE
PRIORITY NA	

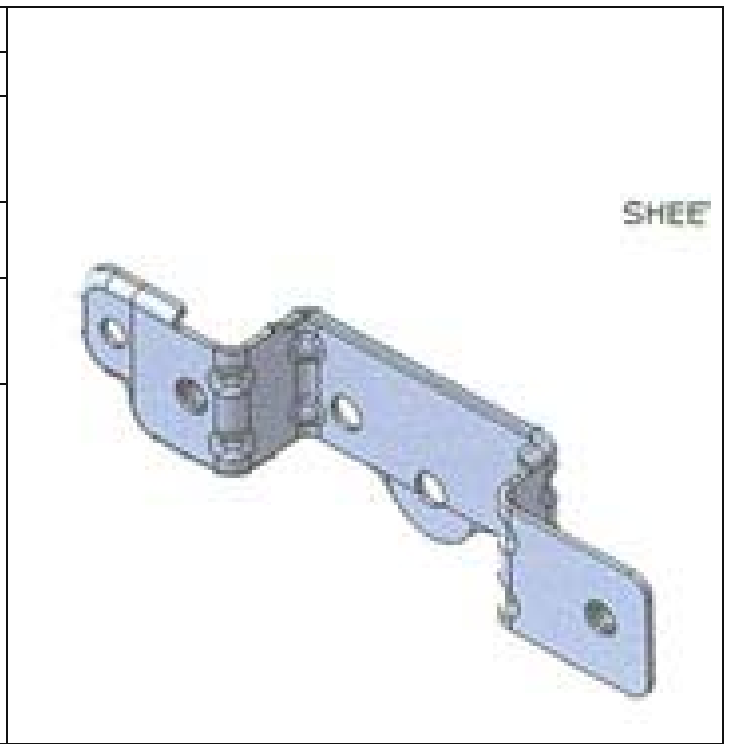

DESIGN NUMBER	261102
CLASS	15-07
1)PRADEEPKUMAR NANDLAL DHOOT, INDIAN NATIONAL OF GANGAPURWALA, 2275 ADAT BAZAR, AHMEDNAGAR-414001, MAHARASHTRA, INDIA	
DATE OF REGISTRATION	19/03/2014
TITLE	BASE STAND ASSEMBLY FOR REFRIGERATOR
PRIORITY NA	



DESIGN NUMBER	260268
CLASS	21-01
1)LUNA MANUFACTURING COMPANY, 6966, AHATA KIDARA, PAHARI DHIRAJ, DELHI-110006 (INDIA), (AN INDIAN PARTNERSHIP FIRM), WHOSE PARTNERS ARE RAJ KUMAR JAIN & KANWAR BHAN JAIN, BOTH INDIAN NATIONALS AND AT THE SAME ABOVE ADDRESS	
DATE OF REGISTRATION	11/02/2014
TITLE	TOY
PRIORITY NA	



DESIGN NUMBER	260430	
CLASS	09-03	
1)PARIS PERFUMES & COSMETICS PVT LTD. AN INDIAN NATIONAL COMPANY INCORPORATED UNDER THE COMPANIES ACT 1956 BARODA-JAMBUSAR N. H. WAY ROAD, AT & PO. DABHASA, TA. PADRA-391440, DIST. BARODA (GUJARAT), INDIA		
DATE OF REGISTRATION	18/02/2014	
TITLE	CONTAINER	
PRIORITY NA		
DESIGN NUMBER	260888	
CLASS	09-07	
1)MA DESIGN INDIA PRIVATE LIMITED, A COMPANY INCORPORATED IN INDIA HAVING ITS PRINCIPAL PLACE OF BUSINESS AT A-41, SECTOR-80, PHASE-II, NOIDA-201305, U.P. INDIA		
DATE OF REGISTRATION	10/03/2014	
TITLE	STOPPER FOR BOTTLE	
PRIORITY NA		
DESIGN NUMBER	259496	
CLASS	11-02	
1)AMAR SINGH YADAV, TRADING AS M/S. S. N. GLASS DECORATORS, SITUATED AT 2/778, SUHAG NAGAR, FIROZABAD (U.P.) INDIA, OF ABOVE ADDRESS		
DATE OF REGISTRATION	20/01/2014	
TITLE	FLOWER VASE	
PRIORITY NA		

DESIGN NUMBER	258365		
CLASS	12-16		
1)DAIMLER INDIA COMMERCIAL VEHICLES PRIVATE LIMITED, AN INDIAN COMPANY INCORPORATED UNDER THE LAWS OF INDIA, OF UNIT 201, 2ND FLOOR CAMPUS 3B, RMZ MILLENNIA BUSINESS PARK NO. 143, DR. MGR ROAD, PERUNGUDI, CHENNAI-600096, INDIA			
DATE OF REGISTRATION	25/11/2013		
TITLE	BUMPER FOR VEHICLES		
PRIORITY			
PRIORITY NUMBER	DATE	COUNTRY	
002244459-0008	27/05/2013	OHIM	
DESIGN NUMBER	261176		
CLASS	09-01		
1)SH. GURPREET SINGH, AN INDIAN NATIONAL, TRADING AS M/S. JAGAIT INTERNATIONAL, J-43, BHAGAT SINGH PARK, G. T. KARNAL ROAD, SIRASPUR, DELHI-110042			
DATE OF REGISTRATION	21/03/2014		
TITLE	BOTTLE		
PRIORITY NA			
DESIGN NUMBER	259731		
CLASS	12-16		
1)HERO MOTOCORP LIMITED, A COMPANY INCORPORATED UNDER THE INDIAN COMPANIES ACT, HAVING ITS OFFICE AT 34, COMMUNITY CENTRE, BASANT LOK, VASANT VIHAR, NEW DELHI-110057			
DATE OF REGISTRATION	28/01/2014		
TITLE	FAIRING FOR A TWO WHEELED VEHICLE		
PRIORITY NA			

DESIGN NUMBER	260851	
CLASS	12-16	
1)MITRAS BIKES PRIVATE LIMITED, 308, SUNEHRI BAGH APARTMENTS, SECTOR 13, ROHINI, DELHI 110085, DELHI STATE, INDIA, A PRIVATE LIMITED COMPANY INCORPORATED UNDER THE INDIAN COMPANIES ACT, 1956		
DATE OF REGISTRATION	10/03/2014	
TITLE	BACK REST FOR BICYCLES AND TRICYCLES	
PRIORITY NA		
DESIGN NUMBER	261174	
CLASS	02-04	
1)KHADIM INDIA LIMITED, AN INDIAN COMPANY HAVING ITS REGISTERED OFFICE AT KANKARIA ESTATE, 5TH FLOOR, 6, LITTLE RUSSELL STREET KOLKATA 700071, WEST BENGAL, INDIA		
DATE OF REGISTRATION	21/03/2014	
TITLE	FOOTWEAR	
PRIORITY NA		
DESIGN NUMBER	261287	
CLASS	08-06	
1)(1) KASHYAP A. PATEL (2) SANDIP S. GHONIYA (3) VINAYBHAI M. PATEL (4) PARESH D. RAIYANI ALL INDIAN NATIONAL PARTNERS OF YAKSH SALES CORPORATION AN INDIAN PARTNERSHIP FIRM HAVING ITS PRINCIPAL PLACE OF BUSINESS AT SANSKAR SOCIETY, STREET NO. 1, PLOT NO. 28, NEAR BALAJI INDUSTRIES, AJI RING ROAD, RAJKOT, GUJARAT-INDIA		
DATE OF REGISTRATION	27/03/2014	
TITLE	HANDLE	
PRIORITY NA		

DESIGN NUMBER	261350	
CLASS	08-07	
1)SH. NEERAJ MAHESHWARI, PROPRIETOR M/S CENT METAL INDUSTRIES, B-12, INDUSTRIAL ESTATE, ALIGARH-202001 (UTTAR PRADESH) (INDIAN NATIONAL)		
DATE OF REGISTRATION	28/03/2014	
TITLE	DOOR BOLT	
PRIORITY NA		

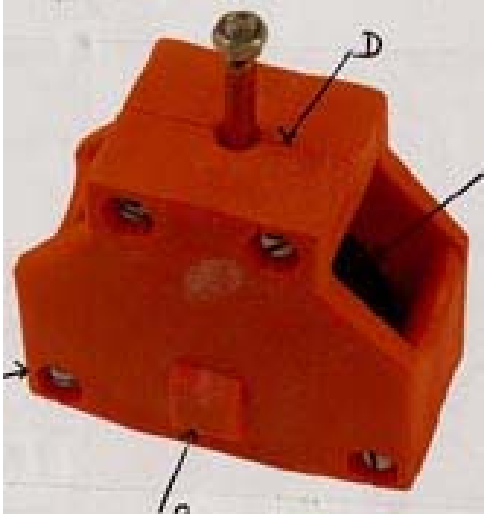
DESIGN NUMBER	256795	
CLASS	12-05	
1)M/S. KUMBHOJKAR PLASTIC MOULDERS, A REGISTERED PARTNERSHIP FIRM WHOSE PARTNERS ARE 1) ARUN SHAMRAO KUMBHOJKAR AND 2) ANAND ARUN KUMBHOJKAR, BOTH RESIDING AT 425/3, SHARAD CHNADRA, FLAT 1, TMV COLONY, MUKUND NAGAR ROAD, PUNE 411037 MAHARASHTRA, INDIA AND HAVING OFFICE AT 129, NARAYAN PETH, SITAPHAL BAUG COLONY, NEAR MATI GANAPATI, PUNE 411030 MAHARASHTRA, INDIA		
DATE OF REGISTRATION	26/09/2013	
TITLE	CABLE CARRIER CRANES	
PRIORITY NA		

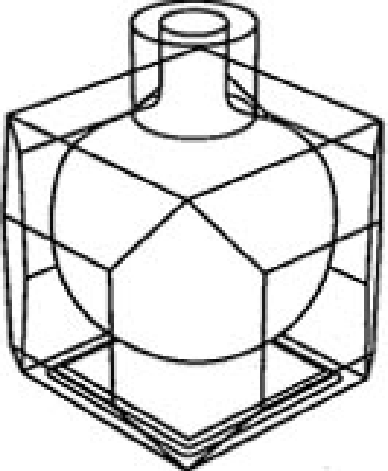
DESIGN NUMBER	261755	
CLASS	09-01	
1)CHRISTIAN LOUBOUTIN, A FRENCH CITIZEN, OF 1 RUE VOLNEY, 75002 PARIS, FRANCE		
DATE OF REGISTRATION	15/04/2014	
TITLE	COSMETIC BOTTLE	
PRIORITY NA		

DESIGN NUMBER	260729	
CLASS	02-04	
1)KABUSHIKI KAISHA HIMIKO (HIMIKO CO., LTD), 17-10, JINGUMAE 6-CHOME, SHIBUYA-KU, TOKYO, JAPAN, NATIONALITY: JAPAN		
DATE OF REGISTRATION	28/02/2014	
TITLE	INSOLE OF FOOTWEAR	
PRIORITY		
PRIORITY NUMBER	DATE	COUNTRY
2013-025393	30/10/2013	JAPAN

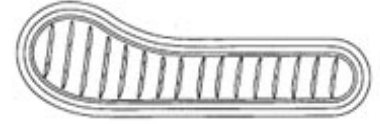



DESIGN NUMBER	260889	
CLASS	07-03	
1)MA DESIGN INDIA PRIVATE LIMITED, A COMPANY INCORPORATED IN INDIA HAVING ITS PRINCIPAL PLACE OF BUSINESS AT A-41, SECTOR-80, PHASE-II, NOIDA-201305, U.P. INDIA		
DATE OF REGISTRATION	10/03/2014	
TITLE	BREAD KNIFE	
PRIORITY NA		







DESIGN NUMBER	259366	
CLASS	09-99	
1)PEPSICO, INC., INCORPORATED IN NORTH CAROLINA OF 700 ANDERSON HILL ROAD, PURCHASE, NEW YORK 10577, UNITED STATES OF AMERICA		
DATE OF REGISTRATION	13/01/2014	
TITLE	COASTER	
PRIORITY		
PRIORITY NUMBER	DATE	COUNTRY
29/460,543	11/07/2013	U.S.A.



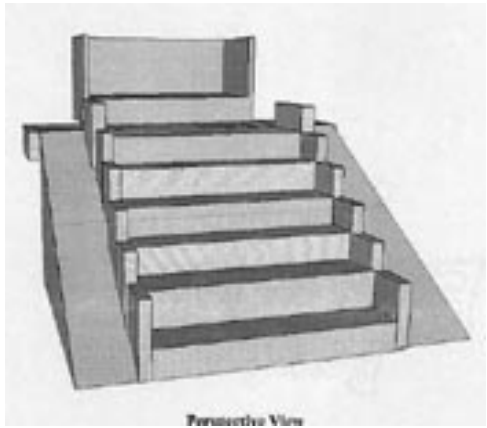

DESIGN NUMBER	259519	
CLASS	06-01	
1)THE SUPREME INDUSTRIES LTD., (AN INDIAN PUBLIC LIMITED COMPANY), 601 CENTRAL PLAZA, 2/6, SARAT BOSE ROAD, KOLKATA - 700020, WEST BENGAL, INDIA		
DATE OF REGISTRATION	20/01/2014	
TITLE	CHAIR	
PRIORITY NA		

DESIGN NUMBER	258366	
CLASS	12-16	
1)DAIMLER INDIA COMMERCIAL VEHICLES PRIVATE LIMITED, AN INDIAN COMPANY INCORPORATED UNDER THE LAWS OF INDIA, OF UNIT 201, 2ND FLOOR CAMPUS 3B, RMZ MILLENNIA BUSINESS PARK NO. 143, DR. MGR ROAD, PERUNGUDI, CHENNAI-600096, INDIA		
DATE OF REGISTRATION	25/11/2013	
TITLE	BUMPER FOR VEHICLES	
PRIORITY		
PRIORITY NUMBER	DATE	COUNTRY
002244459-0009	27/05/2013	OHIM



DESIGN NUMBER	257564	
CLASS	30-99	
1)MANOJ GOYAL, 15/84 CHOPASNI HOUSING BOARD, JODHPUR, RAJASTHAN, 342001, NATIONALITY: INDIAN		
DATE OF REGISTRATION	18/10/2013	
TITLE	STAIRCASE FOR SCREENING OF ACTIVITY OF MICE	
PRIORITY NA		



DESIGN NUMBER	259732	
CLASS	12-16	
1)HERO MOTOCORP LIMITED, A COMPANY INCORPORATED UNDER THE INDIAN COMPANIES ACT, HAVING ITS OFFICE AT 34, COMMUNITY CENTRE, BASANT LOK, VASANT VIHAR, NEW DELHI-110057		
DATE OF REGISTRATION	28/01/2014	
TITLE	SIDE FAIRING FOR A TWO WHEELED VEHICLE	
PRIORITY NA		
DESIGN NUMBER	260270	
CLASS	21-01	
1)PARAG JAIN, AN INDIAN NATIONAL, SOLE PROPRIETOR OF LUNA TOYS, (AN INDIAN SOLE PROPRIETARY FIRM) 1329, GALI NO. 3, FAIZ GANJ, BAHADUR GARH ROAD, DELHI-110006, INDIA		
DATE OF REGISTRATION	11/02/2014	
TITLE	TOY	
PRIORITY NA		
DESIGN NUMBER	260890	
CLASS	07-06	
1)MA DESIGN INDIA PRIVATE LIMITED, A COMPANY INCORPORATED IN INDIA HAVING ITS PRINCIPAL PLACE OF BUSINESS AT A-41, SECTOR-80, PHASE-II, NOIDA-201305, U.P. INDIA		
DATE OF REGISTRATION	10/03/2014	
TITLE	NAPKIN HOLDER	
PRIORITY NA		

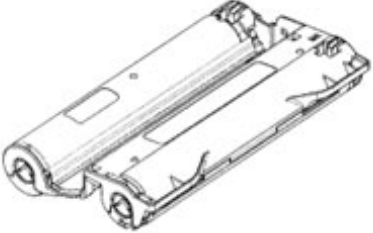

DESIGN NUMBER	259520	
CLASS	06-01	
1)THE SUPREME INDUSTRIES LTD., (AN INDIAN PUBLIC LIMITED COMPANY), 601 CENTRAL PLAZA, 2/6, SARAT BOSE ROAD, KOLKATA - 700020, WEST BENGAL, INDIA		
DATE OF REGISTRATION	20/01/2014	
TITLE	CHAIR	
PRIORITY NA		

DESIGN NUMBER	258367		
CLASS	06-01		
1)DAIMLER INDIA COMMERCIAL VEHICLES PRIVATE LIMITED, AN INDIAN COMPANY INCORPORATED UNDER THE LAWS OF INDIA, OF UNIT 201, 2ND FLOOR CAMPUS 3B, RMZ MILLENNIA BUSINESS PARK NO. 143, DR. MGR ROAD, PERUNGUDI, CHENNAI-600096, INDIA			
DATE OF REGISTRATION	25/11/2013		
TITLE	SEAT FOR VEHICLES		
PRIORITY			
PRIORITY NUMBER	DATE	COUNTRY	
002244335-0001	27/05/2013	OHIM	

DESIGN NUMBER	259733		
CLASS	12-16		
1)HERO MOTOCORP LIMITED, A COMPANY INCORPORATED UNDER THE INDIAN COMPANIES ACT, HAVING ITS OFFICE AT 34, COMMUNITY CENTRE, BASANT LOK, VASANT VIHAR, NEW DELHI-110057			
DATE OF REGISTRATION	28/01/2014		
TITLE	INSTRUMENT CLUSTER FOR A TWO WHEELED VEHICLE		
PRIORITY NA			

DESIGN NUMBER	260271		
CLASS	21-01		
1) PARAG JAIN, AN INDIAN NATIONAL, SOLE PROPRIETOR OF LUNA TOYS, (AN INDIAN SOLE PROPRIETARY FIRM) 1329, GALI NO. 3, FAIZ GANJ, BAHADUR GARH ROAD, DELHI-110006, INDIA			
DATE OF REGISTRATION	11/02/2014		
TITLE	TOY		
PRIORITY NA			
DESIGN NUMBER	261114		
CLASS	18-02		
1) CANON KABUSHIKI KAISHA, A JAPANESE CORPORATION OF 30-2, SHIMOMARUKO 3-CHOME, OHTA-KU, TOKYO, JAPAN			
DATE OF REGISTRATION	19/03/2014		
TITLE	INK RIBBON CASSETTE FOR PRINTER		
PRIORITY			
PRIORITY NUMBER	DATE	COUNTRY	
2013-021757	20/09/2013	JAPAN	
DESIGN NUMBER	260023		
CLASS	12-08		
1) BAJAJ AUTO LIMITED, AN INDIAN COMPANY, INCORPORATED UNDER THE COMPANIES ACT OF 1956, HAVING ITS PRINCIPAL PLACE OF BUSINESS AT NEW 2ND & 3RD FLOOR, KHIVRAJ BUILDING, NO. 616, ANNASALAI, CHENNAI - 600006, STATE OF TAMIL NADU, INDIA, AND REGISTERED OFFICE AT AKURDI, PUNE-411035, STATE OF MAHARASHTRA, INDIA			
DATE OF REGISTRATION	03/02/2014		
TITLE	VEHICLE		
PRIORITY NA			



DESIGN NUMBER	259131	
CLASS	23-01	
1)ASHIRVAD PIPES PVT. LTD, A COMPANY REGISTERED UNDER THE COMPANIES ACT 1956 HAVING ITS REGISTERED OFFICE AT 4-B, ATTIBELE INDUSTRIAL AREA, HOSUR ROAD, BANGALORE-562107, KARNATAKA, INDIA;		
DATE OF REGISTRATION	30/12/2013	
TITLE	SEALING RING	
PRIORITY NA		
DESIGN NUMBER	261179	
CLASS	06-04	
1)WIM PLAST LIMITED, A PUBLIC LIMITED COMPANY REGISTERED UNDER THE PROVISION OF COMPANIES ACT, 1956, HAVING OFFICE ADDRESS AT 1ST FLOOR, CORPORATE AVENUE, 'B' WING, CELLO HOUSE, SONAWALA ROAD, GOREGAON (EAST), MUMBAI-400063, MAHARASHTRA, INDIA		
DATE OF REGISTRATION	21/03/2014	
TITLE	CUPBOARD	
PRIORITY NA		
DESIGN NUMBER	259734	
CLASS	12-11	
1)HERO MOTOCORP LIMITED, A COMPANY INCORPORATED UNDER THE INDIAN COMPANIES ACT, HAVING ITS OFFICE AT 34, COMMUNITY CENTRE, BASANT LOK, VASANT VIHAR, NEW DELHI-110057		
DATE OF REGISTRATION	28/01/2014	
TITLE	TWO WHEELED VEHICLE	
PRIORITY NA		



DESIGN NUMBER	260905	
CLASS	26-05	
1)M/S KINGO PRODUCTS (INDIA) 7512/84-C, STREET NO. 9, NEW AMAR NAGAR, DHABA ROAD, LUDHIANA-141003 (PUNJAB) INDIA AN INDIAN PROPRIETORSHIP FIRM WHOSE PROPRIETOR IS:- KULWANT SINGH BEING INDIAN NATIONALS OF THE ABOVE ADDRESS		
DATE OF REGISTRATION	11/03/2014	
TITLE	CONCEALED LIGHTING SYSTEM	
PRIORITY NA		
DESIGN NUMBER	260028	
CLASS	09-01	
1)PRAMIT SANGHAVI AND DEWANG SANGHAVI, PARTNERS TRADING AS V2 CORP., A PARTNERSHIP FIRM, INDIAN, MANUFACTURERS AND MERCHANTS, WHOSE ADDRESS IS WZ-8/1, INDUSTRIAL AREA, KIRTI NAGAR, NEW DELHI-110015, INDIA		
DATE OF REGISTRATION	03/02/2014	
TITLE	BOTTLE	
PRIORITY NA		
DESIGN NUMBER	255463	
CLASS	04-02	
1)SHREE SIMANDHAR INDUSTRIES IS A PROPRIETORSHIP FIRM OF 21, NEW MANU BHUVAN, BHAGAT SINGH ROAD, VILE PARLE (W) MUMBAI-400056, MAHARASHTRA, INDIA		
DATE OF REGISTRATION	23/07/2013	
TITLE	HAIR BRUSH	
PRIORITY NA		

DESIGN NUMBER	260893	
CLASS	15-03	
1)TRACTORS AND FARM EQUIPMENT LIMITED, COMPANY INCORPORATED UNDER THE COMPANIES ACT, 1956, HAVING ITS REGISTERED OFFICE AT NO. 861, ANNASALAI, CHENNAI-600002, TAMIL NADU, INDIA		
DATE OF REGISTRATION	10/03/2014	
TITLE	SEED PLANTER	
PRIORITY NA		

DESIGN NUMBER	259736	
CLASS	12-16	
1)HERO MOTOCORP LIMITED, A COMPANY INCORPORATED UNDER THE INDIAN COMPANIES ACT, HAVING ITS OFFICE AT 34, COMMUNITY CENTRE, BASANT LOK, VASANT VIHAR, NEW DELHI-110057		
DATE OF REGISTRATION	28/01/2014	
TITLE	FRONT FAIRING FOR A TWO WHEELED VEHICLE	
PRIORITY NA		

DESIGN NUMBER	261428	
CLASS	08-07	
1)MR. NIRMAL SINGH, AN INDIAN CITIZEN, PROPRIETOR OF M/S. GURU HARKRISHAN MECHANICAL WORKS, AN INDIAN PROPRIETORSHIP COMPANY OF WZ-87, GALI NO. 27, SANT GARH, TILAK NAGAR, NEW DELHI-110018, INDIA		
DATE OF REGISTRATION	01/04/2014	
TITLE	DOOR CLOSER	
PRIORITY NA		

DESIGN NUMBER	260904	
CLASS	03-01	
1)VENUS INTERNATIONAL, OSWAL COMPLEX, G.T. ROAD, INDUSTRIAL AREA-C, LUDHIANA-141003 INDIA AN INDIAN PROPRIETORSHIP FIRM WHOSE PROPRIETOR IS:- BHIMSAIN CHHABRA BEING INDIAN NATIONALS OF THE ABOVE ADDRESS		
DATE OF REGISTRATION	11/03/2014	
TITLE	TOOL BOX FOR SPANNERS	
PRIORITY NA		
DESIGN NUMBER	260948	
CLASS	12-16	
1)TRACTORS AND FARM EQUIPMENT LIMITED, COMPANY INCORPORATED UNDER THE COMPANIES ACT, 1956, HAVING ITS REGISTERED OFFICE AT NO. 861, ANNASALAI, CHENNAI-600002, TAMIL NADU, INDIA		
DATE OF REGISTRATION	13/03/2014	
TITLE	ENGINE COVER	
PRIORITY NA		
DESIGN NUMBER	260272	
CLASS	21-01	
1)PARAG JAIN, AN INDIAN NATIONAL, SOLE PROPRIETOR OF LUNA TOYS, (AN INDIAN SOLE PROPRIETARY FIRM) 1329, GALI NO. 3, FAIZ GANJ, BAHADUR GARH ROAD, DELHI-110006, INDIA		
DATE OF REGISTRATION	11/02/2014	
TITLE	TOY	
PRIORITY NA		

DESIGN NUMBER	260635		
CLASS	15-05		
1)KRISHAN KUMAR JANGRA, AN INDIAN CITIZEN HAVING ADDRESS AT SANJEEV JANGRA ENGG. WORKS, VPO BADO PATTI, BUS STAND, BEHBAL PUR, HISAR (HARYANA), INDIA AND DHANANJAI KUMAR SHARMA, AN INDIAN CITIZEN HAVING ADDRESS AT SANJEEV JANGRA ENGG. WORKS, VPO BADO PATTI, BUS STAND, BEHBAL PUR, HISAR (HARYANA), INDIA			
DATE OF REGISTRATION	26/02/2014		
TITLE	VEGETABLE WASHER		
PRIORITY NA			
DESIGN NUMBER	257169		
CLASS	08-07		
1)WELMADE LOCKING SYSTEMS PVT. LTD., A COMPANY INCORPORATED UNDER THE INDIAN COMPANIES ACT, AT J-61, M.I.D.C., BHOSARI, PUNE-411 026, MAHARASHTRA, INDIA.			
DATE OF REGISTRATION	03/10/2013		
TITLE	KEY		
PRIORITY NA			
DESIGN NUMBER	261300		
CLASS	14-99		
1)IDOIT CO., LTD., NOS. 635, 637, 639, AND 641, 237 SANGIDAEHAK-RO, SIHEUNG-SI, GYEONGGI-DO, KOREA, NATIONALITY: KOREA			
DATE OF REGISTRATION	27/03/2014		
TITLE	SATELLITE ANTENNA SUPPORT		
PRIORITY			
PRIORITY NUMBER	DATE	COUNTRY	
30-2014-0006211	07/02/2014	REPUBLIC OF KOREA	

DESIGN NUMBER	259735	
CLASS	12-16	
1)HERO MOTOCORP LIMITED, A COMPANY INCORPORATED UNDER THE INDIAN COMPANIES ACT, HAVING ITS OFFICE AT 34, COMMUNITY CENTRE, BASANT LOK, VASANT VIHAR, NEW DELHI-110057		
DATE OF REGISTRATION	28/01/2014	
TITLE	FENDER FOR A TWO WHEELED VEHICLE	
PRIORITY NA		
DESIGN NUMBER	259190	
CLASS	12-16	
1)M/S. PRIMROSE MULTIPLAST PVT. LIMITED; A COMPANY INCORPORATED AND EXISTING UNDER THE LAWS OF INDIAN COMPANIES ACT, 1956; OF THE ADDRESS: 2416, M.I.E., BAHADURGARH-124507, HARYANA		
DATE OF REGISTRATION	03/01/2014	
TITLE	FRONT GUARD PILLAR FOR VEHICLES	
PRIORITY NA		
DESIGN NUMBER	261302	
CLASS	13-03	
1)LARSEN & TOUBRO LIMITED, AN INDIAN COMPANY INCORPORATED UNDER THE COMPANIES ACT, 1956 OF L & T HOUSE, BALLARD ESTATE, MUMBAI 400001, STATE OF MAHARASHTRA, INDIA		
DATE OF REGISTRATION	27/03/2014	
TITLE	ELECTROMAGNETIC CONTACTOR	
PRIORITY NA		

DESIGN NUMBER	259737	
CLASS	12-11	
1)HERO MOTOCORP LIMITED, A COMPANY INCORPORATED UNDER THE INDIAN COMPANIES ACT, HAVING ITS OFFICE AT 34, COMMUNITY CENTRE, BASANT LOK, VASANT VIHAR, NEW DELHI-110057		
DATE OF REGISTRATION	28/01/2014	
TITLE	TWO WHEELED VEHICLE	
PRIORITY NA		
		
DESIGN NUMBER	261435	
CLASS	15-07	
1)WHIRLPOOL OF INDIA LIMITED, AN INDIAN COMPANY HAVING ITS CORPORATE OFFICE AT 'WHIRLPOOL HOUSE', PLOT NO. 40, SECTOR-44, GURGAON-122002, HARYANA, INDIA		
DATE OF REGISTRATION	01/04/2014	
TITLE	REFRIGERATOR	
PRIORITY NA		
		
DESIGN NUMBER	261127	
CLASS	24-02	
1)KABUSHIKI KAISHA TOSHIBA, A JAPANESE CORPORATION, OF 1-1, SHIBAURA 1-CHOME, MINATO-KU, TOKYO, JAPAN		
DATE OF REGISTRATION	20/03/2014	
TITLE	BIOMEDICAL SIGNAL RECORDER	
PRIORITY		
PRIORITY NUMBER	DATE	COUNTRY
2013-022112	25/09/2013	JAPAN
		

DESIGN NUMBER	261788	
CLASS	09-01	
1)BDN PHARMACEUTICALS, HAVING THE PRINCIPLE OFFICE AT 229, NEAR ZENDA CHOWK, DHARAMPETH, NAGPUR-440010, INDIA A PARTNERSHIP CONCERN HAVING THE PARTNERS 1) SATISH SHRIRAM DIDOLKAR AND 2) ANAND SATISH DIDOLKAR RESIDING AT W-4, HINGNA MIDC INDUSTRIAL AREA, NAGPUR-440028, INDIA		
DATE OF REGISTRATION	16/04/2014	
TITLE	BOTTLE	
PRIORITY NA		
DESIGN NUMBER	260898	
CLASS	13-03	
1)ROLEX SWITCHGEAR, OPPOSITE NEW TEHSIL, P.O. AHMEDGARH-148021 (PUNJAB) INDIA AN INDIAN PROPRIETORSHIP FIRM WHOSE PROPRIETOR IS POONAM JAIN BEING INDIAN NATIONALS OF THE ABOVE ADDRESS		
DATE OF REGISTRATION	11/03/2014	
TITLE	AUTOMATIC MOTOR STARTER	
PRIORITY NA		
DESIGN NUMBER	258307	
CLASS	13-03	
1)SCHNEIDER ELECTRIC INDUSTRIES SAS, A COMPANY INCORPORATED UNDER THE LAWS OF FRANCE, OF THE ADDRESS 35, RUE JOSEPH MONIER, 92500 RUEIL-MALMAISON, FRANCE		
DATE OF REGISTRATION	22/11/2013	
TITLE	TERMINAL BLOCK USEN AS A CABLING DEVICE FOR MOTOR-STARTERS	
PRIORITY		
PRIORITY NUMBER	DATE	COUNTRY
002268748-0001	04/07/2013	OHIM

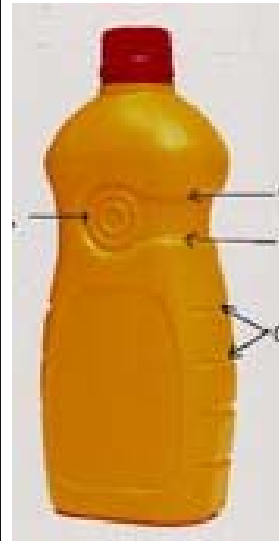



DESIGN NUMBER	259192	
CLASS	07-01	
1)RAVISSANT PRIVATE LIMITED, AN INDIAN COMPANY, OF THE ADDRESS 50-51, COMMERCIAL COMPLEX, NEW FRIENDS COLONY, NEW DELHI-110065, INDIA		
DATE OF REGISTRATION	03/01/2014	
TITLE	BOWL	
PRIORITY NA		

DESIGN NUMBER	261258	
CLASS	06-10	
1)RAJILKUMAR MAGANLAL TRAMBADIA (ADULT & INDIAN NATIONAL) PROPRIETOR OF SHREE NILKANTHVARIVI CREATION (INDIAN PROPRIETORSHIP CONCERN) HAVING PLACE OF BUSINESS AT: NAVRANGPARA-8, MAVDI PLOT, RAJKOT-GUJARAT-(INDIA)		
DATE OF REGISTRATION	27/03/2014	
TITLE	CURTAIN BRACKET	
PRIORITY NA		



DESIGN NUMBER	259739	
CLASS	12-16	
1)HERO MOTOCORP LIMITED, A COMPANY INCORPORATED UNDER THE INDIAN COMPANIES ACT, HAVING ITS OFFICE AT 34, COMMUNITY CENTRE, BASANT LOK, VASANT VIHAR, NEW DELHI-110057		
DATE OF REGISTRATION	28/01/2014	
TITLE	FRONT VISOR FOR A TWO WHEELED VEHICLE	
PRIORITY NA		

DESIGN NUMBER	261787	
CLASS	26-02	
1)JALARAM INDUSTRIES, HAVING THE PRINCIPAL OFFICE AT 241, BOMBAY TALKIES COMPOUND, SHREE RAM MARG, MALAD (W), MUMBAI-400064 MAHARASHTRA, INDIA A PROPRIETARY CONCERN HAVING THE PROPRIETOR - ASHOK RAMANLAL PANCHAL RESIDING AT D/11, SHALIMAR APT, NEXT TO H.D.F.C. BANK, MARVE ROAD, MALAD (W), MUMBAI-400064, MAHARASHTRA, INDIA, AN INDIAN NATIONAL		
DATE OF REGISTRATION	16/04/2014	
TITLE	OIL LAMP	
PRIORITY NA		
DESIGN NUMBER	260828	
CLASS	31-01	
1)KISHAN INDUSTRIES OF METODA G. I. D. C., PLOT NO. G-1613, NEAR BALAJI MULTIFLEX, F-ROAD, STREET NO. A-7, METODA, TALUKA-LODHKA, DISTRICT-RAJKOT, STATE OF GUJARAT, INDIA, AN INDIAN PARTNERSHIP FIRM WHOSE PARTNERS ARE RAKESH SAVJIBHAI PARSANA, SAVJIBHAI DUNGARBHAI PARSANA, PARSOTTAMBHAI DUNGARBHAI PARSANA AND KISHAN PARSOTTAMBHAI PARSANA, INDIAN NATIONALS OF THE ABOVE ADDRESS		
DATE OF REGISTRATION	07/03/2014	
TITLE	JUICER	
PRIORITY NA		
DESIGN NUMBER	261303	
CLASS	15-03	
1)MILLTEC MACHINERY PRIVATE LIMITED OF NO. 51-A, 1ST PHASE KIADB INDL AREA, BOMMASANDRA, BANGALORE-560099, STATE OF KARNATAKA, INDIA, AN INDIAN COMPANY		
DATE OF REGISTRATION	27/03/2014	
TITLE	GRAIN PRE-CLEANER	
PRIORITY NA		

DESIGN NUMBER	261437		
CLASS	09-03		
1)COLGATE-PALMOLIVE COMPANY, A DELAWARE CORPORATION, 300 PARK AVENUE, NEW YORK, NEW YORK 10022, UNITED STATES OF AMERICA			
DATE OF REGISTRATION	01/04/2014		
TITLE	CONTAINER		
PRIORITY			
PRIORITY NUMBER	DATE	COUNTRY	
29/472,029	07/11/2013	U.S.A.	
DESIGN NUMBER	261045		
CLASS	09-01		
1)ITC LIMITED, AN INDIAN COMPANY WITHIN THE MEANING OF THE COMPANIES ACT, 1956 OF VIRGINIA HOUSE, 37, J. L. NEHRU ROAD, KOLKATA - 700071, WEST BENGAL, INDIA			
DATE OF REGISTRATION	18/03/2014		
TITLE	BOTTLE		
PRIORITY NA			
DESIGN NUMBER	261080		
CLASS	26-99		
1)MA DESIGN INDIA PRIVATE LIMITED, A COMPANY INCORPORATED IN INDIA HAVING ITS PRINCIPAL PLACE OF BUSINESS AT A-41, SECTOR-80, PHASE-II, NOIDA-201305, U.P. INDIA			
DATE OF REGISTRATION	19/03/2014		
TITLE	SNUFFER		
PRIORITY NA			

DESIGN NUMBER	261128		
CLASS	09-03		
1)COLGATE-PALMOLIVE COMPANY, A DELAWARE CORPORATION, 300 PARK AVENUE, NEW YORK, NEW YORK 10022, UNITED STATES OF AMERICA			
DATE OF REGISTRATION	20/03/2014		
TITLE	CONTAINER		
PRIORITY			
PRIORITY NUMBER	DATE	COUNTRY	
29/471,157	29/10/2013	U.S.A.	
DESIGN NUMBER	260864		
CLASS	26-05		
1)B.N.K. ENERGY ALTERNATIVES, 307, SURYA COMPLEX, 21, VEER SAVARKAR BLOCK, SHAKARPUR, DELHI-110092, INDIA (AN INDIAN PROPRIETORSHIP FIRM WHOSE PROPRIETOR IS: SH. SANTOSH RAJGARHIA. AN INDIAN NATIONAL OF THE ABOVE ADDRESS			
DATE OF REGISTRATION	10/03/2014		
TITLE	LED LAMP		
PRIORITY NA			
DESIGN NUMBER	259392		
CLASS	31-01		
1)HAVELLS INDIA LIMITED HAVING REGISTERED OFFICE AT 1, RAJ NARAIN MARG, CIVIL LINES, DELHI 110054			
DATE OF REGISTRATION	15/01/2014		
TITLE	MIXER GRINDER		
PRIORITY NA			



DESIGN NUMBER	258308		
CLASS	13-03		
1)SCHNEIDER ELECTRIC INDUSTRIES SAS, A COMPANY INCORPORATED UNDER THE LAWS OF FRANCE, OF THE ADDRESS 35, RUE JOSEPH MONIER, 92500 RUEIL-MALMAISON, FRANCE			
DATE OF REGISTRATION	22/11/2013		
TITLE	TERMINAL BLOCK USED AS A CABLING DEVICE FOR MOTOR-STRATERS		
PRIORITY			
PRIORITY NUMBER	DATE	COUNTRY	
002268748-0002	04/07/2013	OHIM	
DESIGN NUMBER	259193		
CLASS	07-01		
1)RAVISSANT PRIVATE LIMITED, AN INDIAN COMPANY, OF THE ADDRESS 50-51, COMMERCIAL COMPLEX, NEW FRIENDS COLONY, NEW DELHI-110065, INDIA			
DATE OF REGISTRATION	03/01/2014		
TITLE	BOWL		
PRIORITY NA			
DESIGN NUMBER	261260		
CLASS	06-10		
1)RAJILKUMAR MAGANLAL TRAMBADIA (ADULT & INDIAN NATIONAL) PROPRIETOR OF SHREE NILKANTHVARIVI CREATION (INDIAN PROPRIETORSHIP CONCERN) HAVING PLACE OF BUSINESS AT: NAVRANGPARA-8, MAVDI PLOT, RAJKOT-GUJARAT-(INDIA)			
DATE OF REGISTRATION	27/03/2014		
TITLE	CURTAIN BRACKET		
PRIORITY NA			



DESIGN NUMBER	259740	
CLASS	12-11	
1)HERO MOTOCORP LIMITED, A COMPANY INCORPORATED UNDER THE INDIAN COMPANIES ACT, HAVING ITS OFFICE AT 34, COMMUNITY CENTRE, BASANT LOK, VASANT VIHAR, NEW DELHI-110057		
DATE OF REGISTRATION	28/01/2014	
TITLE	TWO WHEELED VEHICLE	
PRIORITY NA		
DESIGN NUMBER	261046	
CLASS	09-01	
1)ITC LIMITED, AN INDIAN COMPANY WITHIN THE MEANING OF THE COMPANIES ACT, 1956 OF VIRGINIA HOUSE, 37, J. L. NEHRU ROAD, KOLKATA - 700071, WEST BENGAL, INDIA		
DATE OF REGISTRATION	18/03/2014	
TITLE	BOTTLE	
PRIORITY NA		
DESIGN NUMBER	261131	
CLASS	03-04	
1)M/S. ORIENT ELECTRICALS (A DIVISION OF ORIENT PAPER & INDUSTRIES LTD.), 11, INDUSTRIAL ESTATE, SECTOR-6, FARIDABAD, HARYANA-121006		
DATE OF REGISTRATION	20/03/2014	
TITLE	CEILING FAN	
PRIORITY NA		

DESIGN NUMBER	257880	
CLASS	08-05	
1)ANTONEY THOMAS, NJONDICKAL (H), OLAYAMPADI(P.O.), MATHAMANGALAM, KANNURE, KERALA.PIN-670306		
DATE OF REGISTRATION	30/10/2013	
TITLE	AGRECULTURE IMPLEMENT FOR REMOVING SHELL-RUBBER	
PRIORITY NA		

DESIGN NUMBER	258309	
CLASS	13-03	
1)SCHNEIDER ELECTRIC INDUSTRIES SAS, A COMPANY INCORPORATED UNDER THE LAWS OF FRANCE, OF THE ADDRESS 35, RUE JOSEPH MONIER, 92500 RUEIL-MALMAISON, FRANCE		
DATE OF REGISTRATION	22/11/2013	
TITLE	TERMINAL BLOCK USED AS A CABLING DEVICE FOR MOTOR- STRATERS	
PRIORITY		
PRIORITY NUMBER	DATE	COUNTRY
002268748-0003	04/07/2013	OHIM

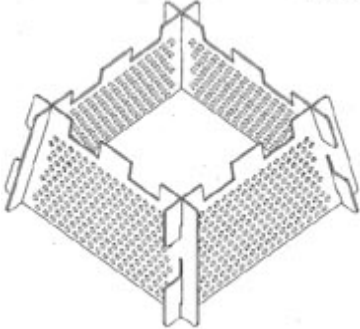
DESIGN NUMBER	259196	
CLASS	02-02	
1)M/S. ROSHAN ENTERPRISES IS A PROPRIETORSHIP FIRM OF GALA NO. 5, GROUND FLOOR, SWASTIK HAMBERS, BELOW KURLA NURSING HOME, PIPE ROAD, KURLA (WEST), MUMBAI- 400070		
DATE OF REGISTRATION	03/01/2014	
TITLE	TROUSER	
PRIORITY NA		

DESIGN NUMBER	256048		
CLASS	12-16		
1)ULPA PRODUCTS AN INDIAN PARTNERSHIP FIRM WHOSE PARTNERS ARE 01. SHAILESH J. PATEL, 02. PRANAV S. PATEL AND 03. KRUNAL S. PATEL, INDIAN NATIONAL WHOSE ADDRESS IS PLOT NO. 6, OHM INDUSTRIAL PARK, COSTAL HIGHWAY, VILLAGE DEHRI, UMBERGAON-396170, DIST. VALSAD, GUJARAT			
DATE OF REGISTRATION	26/08/2013		
TITLE	HANDGRIP FOR TWO-WHEELERS		
PRIORITY NA			
DESIGN NUMBER	261198		
CLASS	08-05		
1)J. V. GOPALAKRISHNA AN INDIAN NATIONAL RESIDING AT 4420, 4TH CROSS, J BLOCK, KANAKADASANAGARA DATTAGALLI 3RD STAGE, MYSORE-570023, KARNATAKA, INDIA			
DATE OF REGISTRATION	24/03/2014		
TITLE	HAND TOOL FOR SURFACE SANDING		
PRIORITY NA			
DESIGN NUMBER	259850		
CLASS	07-02		
1)STANDARD BRANDS (UK) LIMITED, A COMPANY ORGANIZED AND EXISTING UNDER THE LAWS OF UNITED KINGDOM, HAVING PLACE OF BUSINESS AT 4, CLEEVE COURT, CLEEVE ROAD, LEATHERHEAD, SURREY, KT22 7SD, UNITED KINGDOM			
DATE OF REGISTRATION	30/01/2014		
TITLE	COOKING STOVE		
PRIORITY			
PRIORITY NUMBER	DATE	COUNTRY	
001380810-0002	06/08/2013	OHIM	

DESIGN NUMBER	260916		
CLASS	31-00		
1)SANTOS, OF 140-150 AVENUE ROGER SALENGRO, 69120 VAULX-EN-VELIN, FRANCE, A FRENCH SOCIÉTÉ PAR ACTIONS SIMPLIFIÉE			
DATE OF REGISTRATION	11/03/2014		
TITLE	JUICE EXTRACTOR		
PRIORITY			
PRIORITY NUMBER	DATE	COUNTRY	
002311027-0001	17/09/2013	OHIM	
DESIGN NUMBER	261047		
CLASS	09-01		
1)TATA CHEMICALS LIMITED, A COMPANY REGISTERED IN INDIA, HAVING ITS REGISTERED OFFICE AT BOMBAY HOUSE, 24 HOMI MODI STREET, FORT, MUMBAI-400001, STATE OF MAHARASHTRA, INDIA, OF ABOVE ADDRESS			
DATE OF REGISTRATION	18/03/2014		
TITLE	BOTTLE		
PRIORITY NA			
DESIGN NUMBER	261132		
CLASS	03-04		
1)M/S. ORIENT ELECTRICALS (A DIVISION OF ORIENT PAPER & INDUSTRIES LTD.), 11, INDUSTRIAL ESTATE, SECTOR-6, FARIDABAD, HARYANA-121006			
DATE OF REGISTRATION	20/03/2014		
TITLE	CEILING FAN		
PRIORITY NA			

DESIGN NUMBER	260874	
CLASS	09-05	
1) ABDUL NAZER, AN INDIAN CITIZEN, HAVING OFFICE AT NO. 37, DODDENAKUNDI INDUSTRIAL AREA, WHITEFIELD ROAD, MAHADEVAPURA, BANGALORE-560048, INDIA		
DATE OF REGISTRATION	10/03/2014	
TITLE	PACKGE FOR FOOD	
PRIORITY NA		
DESIGN NUMBER	258147	
CLASS	12-15	
1) COMPAGNIE GENERALE DES ETABLISSEMENTS MICHELIN, 12 COURS SABLON - F-63000, CLERMONT-FERRAND, FRANCE, AND MICHELIN RECHERCHE ET TECHNIQUE S.A., ROUTE LOUIS BRAILLE 10- CH-1763, GRANGES-PACCOT, SWITZERLAND		
DATE OF REGISTRATION	14/11/2013	
TITLE	TIRE	
PRIORITY		
PRIORITY NUMBER	DATE	COUNTRY
13/2443	27/05/2013	FRANCE
DESIGN NUMBER	258310	
CLASS	13-03	
1) SCHNEIDER ELECTRIC INDUSTRIES SAS, A COMPANY INCORPORATED UNDER THE LAWS OF FRANCE, OF THE ADDRESS 35, RUE JOSEPH MONIER, 92500 RUEIL-MALMAISON, FRANCE		
DATE OF REGISTRATION	22/11/2013	
TITLE	TERMINAL BLOCK USED AS A CABLING DEVICE FOR MOTOR-STARTERS	
PRIORITY		
PRIORITY NUMBER	DATE	COUNTRY
002268748-0004	04/07/2013	OHIM

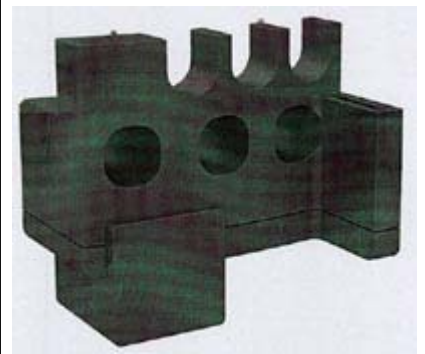
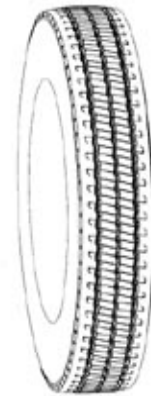

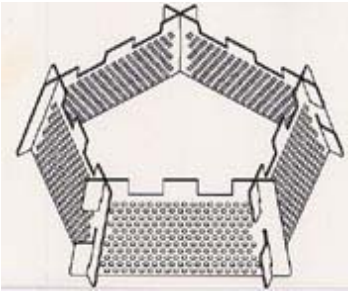
DESIGN NUMBER	261307		
CLASS	12-08		
1)BAYERISCHE MOTOREN WERKE AKTIENGESELLSCHAFT, OF PETUELRING 130, 80809, MUENCHEN, GERMANY, A GERMAN COMPANY			
DATE OF REGISTRATION	27/03/2014		
TITLE	CAR		
PRIORITY			
PRIORITY NUMBER	DATE	COUNTRY	
DE 402013100991.8	30/09/2013	GERMANY	
DESIGN NUMBER	259851		
CLASS	07-02		
1)STANDARD BRANDS (UK) LIMITED, A COMPANY ORGANIZED AND EXISTING UNDER THE LAWS OF UNITED KINGDOM, HAVING PLACE OF BUSINESS AT 4, CLEEVE COURT, CLEEVE ROAD, LEATHERHEAD, SURREY, KT22 7SD, UNITED KINGDOM			
DATE OF REGISTRATION	30/01/2014		
TITLE	COOKING STOVE		
PRIORITY			
PRIORITY NUMBER	DATE	COUNTRY	
001380810-0003	06/08/2013	OHIM	