

INTRODUCTION

In view of the recent amendment made in the Designs (Amendment) Rules, 2008 with effect from 17/06/2008, Publication of the matter relating to Designs is being published in the Official Journal of The Patent Office. This Journal is being published on weekly basis on every Friday covering the various proceedings on Designs as required according to the provisions of under Rule 22, 25, 27 and 39 of the Design (Amendment) Rules, 2008. All the enquiries on this Official Journal and other information as required by the public should be addressed to the Controller General of Patents, Designs & Trade Marks. Suggestions and comments are requested from all quarters so that the content can be enriched.

THE DESIGNS ACT 2000
SECTION 30
DESIGN ASSIGNMENT

The Design stands in the name of PRICOL LIMITED registered under the Designs Act, 2000 has been assigned in the Register of Designs in the name as follows:-

Design No.	Class	Name
208678 220942 230973	24-01	SKANRAY TECHNOLOGIES PRIVATE LIMITED, A COMPANY INCORPORATED UNDER THE PROVISIONS OF THE COMPANIES ACT, 1956, AND HAVING ITS REGISTERED OFFICE AT PLOT # 15- 17, HEBBAL INDUSTRIAL AREA, MYSORE 570 016, STATE OF KARNATAKA,INDIA

CANCELLATION PROCEEDINGS
under Section 19 of the Designs Act, 2000

“The Asstt. Controller of Patents & Designs passed an order on 26/9/2014 to cancel the registration of registered Design No. 228502 dated 9/4/2010 under class 09-01 titled as ‘Bottle’ in the name of Reliance Plast, (an Indian sole proprietorship concern), having office at 202, Pooja Residency, Derasar Lane, Borivali (West), Mumbai – 400092, Maharashtra, India, whose proprietor is Jawahar Jain, (Indian national) of above address”

COPYRIGHT PUBLICATION

SL NO	REGISTERED DESIGN NUMBERS	RENEWED ON
1.	239400	20.08.2014
2.	239042	20.08.2014
3.	240220	20.08.2014
4.	240057	20.08.2014
5.	195685	21.08.2014
6.	195719	21.08.2014
7.	233813	21.08.2014
8.	233814	21.08.2014
9.	234494	21.08.2014
10.	216998	21.08.2014
11.	232160	21.08.2014
12.	239382	21.08.2014
13.	239782	21.08.2014
14.	241745	21.08.2014
15.	249189	21.08.2014

REGISTRATION OF DESIGNS

The following designs have been registered. They are now open for public inspection. In the following each entry the Date of Registration is shown. The Priority Number, Priority Date and Priority Country are also shown

DESIGN NUMBER	259137		
CLASS	08-06		
1)GODREJ & BOYCE MFG. CO. LTD. OF LOCKS DIVISION (PLANT-18), PIROJSHANAGAR, VIKHROLI, MUMBAI - 400079, MAHARASHTRA, INDIA, INDIAN COMPANY			
DATE OF REGISTRATION	30/12/2013		
TITLE	HANDLE		
PRIORITY NA			
DESIGN NUMBER	259507		
CLASS	11-02		
1)AMAR SINGH YADAV, TRADING AS M/S. S. N. GLASS DECORATORS, SITUATED AT 2/778, SUHAG NAGAR, FIROZABAD (U.P.) INDIA, OF ABOVE ADDRESS			
DATE OF REGISTRATION	20/01/2014		
TITLE	FLOWER VASE		
PRIORITY NA			
DESIGN NUMBER	257955		
CLASS	08-09		
1)KYOSHIN KOGYO CO., LTD, A CORPORATION INCORPORATED UNDER THE LAWS OF JAPAN, HAVING ITS OFFICE AT 20-7, EBIE 7-CHOME, FUKUSHIMA-KU, OSAKA-SHI, OSAKA, JAPAN			
DATE OF REGISTRATION	04/11/2013		
TITLE	COLLET CHUCK FOR PIPE EXPANDER		
PRIORITY			
PRIORITY NUMBER	DATE	COUNTRY	
30-2013-0023157	02/05/2013	REPUBLIC OF KOREA	

DESIGN NUMBER	250672	
CLASS	12-08	
1)MAN TRUCK & BUS AG, A GERMAN COMPANY OF DACHAUER STR. 667, 80995 MUNICH, GERMANY		
DATE OF REGISTRATION	03/01/2013	
TITLE	DRIVER'S CAB OF A UTILITY VEHICLE	
PRIORITY		
PRIORITY NUMBER	DATE	COUNTRY
001335210	04/07/2012	OHIM







DESIGN NUMBER	258173	
CLASS	18-01	
1)CASIO KEISANKI KABUSHIKI KAISHA DOING BUSINESS AS CASIO COMPUTER CO., LTD. A JAPANESE COMPANY, INCORPORATED IN JAPAN OF 6-2, HON-MACHI 1-CHOME, SHIBUYA-KU, TOKYO, JAPAN		
DATE OF REGISTRATION	14/11/2013	
TITLE	CALCULATOR	
PRIORITY NA		



DESIGN NUMBER	258893	
CLASS	12-16	
1)HONDA MOTOR CO., LTD., A JAPANESE CORPORATION, OF 1-1, MINAMI-AOYAMA 2-CHOME, MINATO-KU, TOKYO, 107-8556, JAPAN		
DATE OF REGISTRATION	20/12/2013	
TITLE	FRONT BUMPER FOR AUTOMOBILE	
PRIORITY		
PRIORITY NUMBER	DATE	COUNTRY
2013-014750	28/06/2013	JAPAN

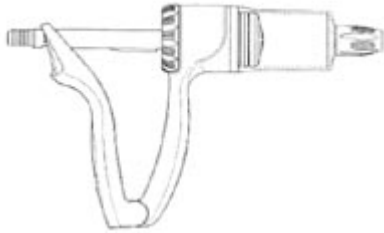

DESIGN NUMBER	259139		
CLASS	08-06		
1)GODREJ & BOYCE MFG. CO. LTD. OF LOCKS DIVISION (PLANT-18), PIROJSHANAGAR, VIKHROLI, MUMBAI - 400079, MAHARASHTRA, INDIA, INDIAN COMPANY			
DATE OF REGISTRATION	30/12/2013		
TITLE	HANDLE		
PRIORITY NA			
DESIGN NUMBER	258293		
CLASS	09-05		
1)SANDVIK INTELLECTUAL PROPERTY AB OF SE-811 81 SANDVIKEN, SWEDEN, A SWEDISH COMPANY			
DATE OF REGISTRATION	21/11/2013		
TITLE	BLISTER PACK		
PRIORITY			
PRIORITY NUMBER	DATE	COUNTRY	
001373427	05/06/2013	OHIM	
DESIGN NUMBER	258563		
CLASS	06-01		
1)STEELCASE INC., 901- 44TH STREET S.E. GRAND RAPIDS, MICHIGAN 49508, USA, NATIONALITY: U.S.A.			
DATE OF REGISTRATION	05/12/2013		
TITLE	CHAIR		
PRIORITY			
PRIORITY NUMBER	DATE	COUNTRY	
29/457, 269	07/06/2013	U.S.A.	

DESIGN NUMBER	259409		
CLASS	24-02		
1)HENKE-SASS, WOLF GMBH, OF KELTENSTRASSE 1, 78532 TUTTLINGEN, GERMANY, A GERMAN COMPANY			
DATE OF REGISTRATION	15/01/2014		
TITLE	VETERINARY INJECTOR		
PRIORITY			
PRIORITY NUMBER	DATE	COUNTRY	
002276147-0001/0003	17/07/2013	OHIM	
DESIGN NUMBER	259509		
CLASS	11-02		
1)AMAR SINGH YADAV, TRADING AS M/S. S. N. GLASS DECORATORS, SITUATED AT 2/778, SUHAG NAGAR, FIROZABAD (U.P.) INDIA, OF ABOVE ADDRESS			
DATE OF REGISTRATION	20/01/2014		
TITLE	FLOWER VASE		
PRIORITY NA			
DESIGN NUMBER	259561		
CLASS	12-16		
1)HONDA MOTOR CO., LTD., A JAPANESE CORPORATION, OF 1-1, MINAMI-AOYAMA 2-CHOME, MINATO-KU, TOKYO, JAPAN			
DATE OF REGISTRATION	22/01/2014		
TITLE	SIDE COVER FOR MOTORCYCLE		
PRIORITY			
PRIORITY NUMBER	DATE	COUNTRY	
2013-016972	25/07/2013	JAPAN	

DESIGN NUMBER	257813		
CLASS	03-04		
1)KHAITAN (INDIA) LIMITED, AN INDIAN COMPANY OF 46C, JAWAHAR LAL NEHRU ROAD, KOLKATA 700071, WEST BENGAL, INDIA.			
DATE OF REGISTRATION	28/10/2013		
TITLE	CEILING FAN		
PRIORITY NA			
DESIGN NUMBER	250675		
CLASS	12-16		
1)MAN TRUCK & BUS AG, A GERMAN COMPANY OF DACHAUER STR. 667, 80995 MUNICH, GERMANY			
DATE OF REGISTRATION	03/01/2013		
TITLE	FRONT BUMPER OF A UTILITY VEHICLE		
PRIORITY			
PRIORITY NUMBER	DATE	COUNTRY	
001335210	04/07/2012	OHIM	
DESIGN NUMBER	259138		
CLASS	08-06		
1)GODREJ & BOYCE MFG. CO. LTD. OF LOCKS DIVISION (PLANT-18), PIROJSHANAGAR, VIKHROLI, MUMBAI - 400079, MAHARASHTRA, INDIA, INDIAN COMPANY			
DATE OF REGISTRATION	30/12/2013		
TITLE	HANDLE		
PRIORITY NA			

DESIGN NUMBER	258292	
CLASS	09-05	
1)SANDVIK INTELLECTUAL PROPERTY AB OF SE-811 81 SANDVIKEN, SWEDEN, A SWEDISH COMPANY		
DATE OF REGISTRATION	21/11/2013	
TITLE	BLISTER PACK	
PRIORITY		
PRIORITY NUMBER	DATE	COUNTRY
001373427	05/06/2013	OHIM

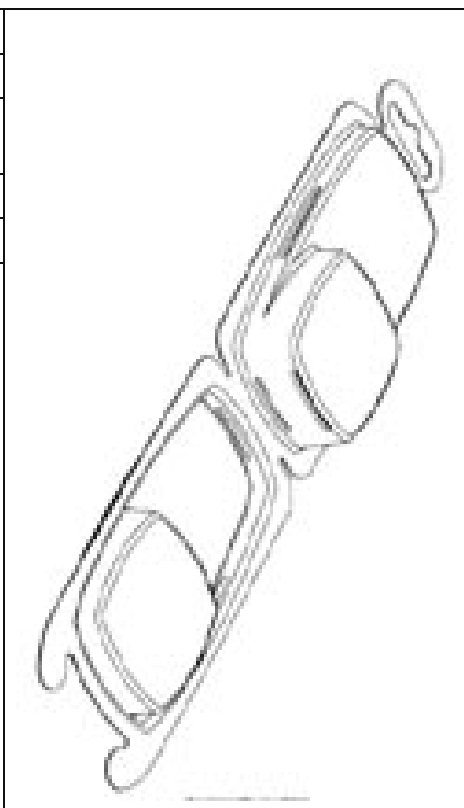



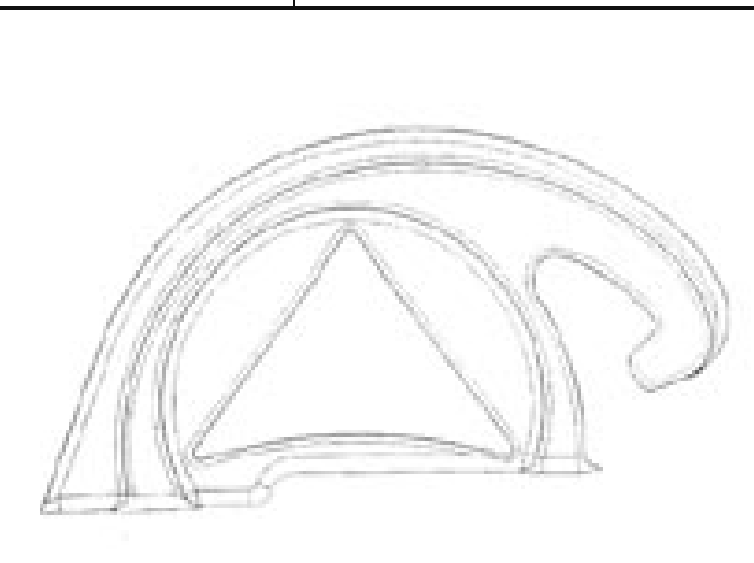

DESIGN NUMBER	259408	
CLASS	24-02	
1)HENKE-SASS, WOLF GMBH, OF KELTENSTRASSE 1, 78532 TUTTLINGEN, GERMANY, A GERMAN COMPANY		
DATE OF REGISTRATION	15/01/2014	
TITLE	HOOK FOR AN INJECTOR	
PRIORITY		
PRIORITY NUMBER	DATE	COUNTRY
002276147-0001/0003	17/07/2013	OHIM





DESIGN NUMBER	259508	
CLASS	11-02	
1)AMAR SINGH YADAV, TRADING AS M/S. S. N. GLASS DECORATERS, SITUATED AT 2/778, SUHAG NAGAR, FIROZABAD (U.P.) INDIA, OF ABOVE ADDRESS		
DATE OF REGISTRATION	20/01/2014	
TITLE	FLOWER VASE	
PRIORITY NA		

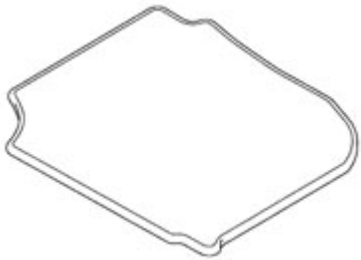

DESIGN NUMBER	259652		 <p>PERSPECTIVE VIEW</p>
CLASS	19-06		
1)SCHWAN-STABILO SCHWANHAEUSSER GMBH & CO. KG, A COMPANY ORGANIZED UNDER THE LAWS OF GERMANY, HAVING ITS ADDRESS AT SCHWANWEG 1, 90562 HEROLDSBERG, GERMANY			
DATE OF REGISTRATION	24/01/2014		
TITLE	WRITING INSTRUMENT		
PRIORITY NA			
DESIGN NUMBER	257812		
CLASS	03-04		
1)KHAITAN (INDIA) LIMITED, AN INDIAN COMPANY OF 46C, JAWAHAR LAL NEHRU ROAD, KOLKATA 700071, WEST BENGAL, INDIA			
DATE OF REGISTRATION	28/10/2013		
TITLE	CEILING FAN		
PRIORITY NA			
DESIGN NUMBER	250674		
CLASS	12-16		
1)MAN TRUCK & BUS AG, A GERMAN COMPANY OF DACHAUER STR. 667, 80995 MUNICH, GERMANY			
DATE OF REGISTRATION	03/01/2013		
TITLE	FRONT GRILL OF A UTILTY VEHICLE		
PRIORITY			
PRIORITY NUMBER	DATE	COUNTRY	
001335210	04/07/2012	OHIM	

DESIGN NUMBER	256184		
CLASS	09-01		
1)PEARL POLYMERS LIMITED, OF A-97/2, OKHLA INDUSTRIAL AREA, PHASE 2, NEW DELHI-110020, INDIA, A COMPANY INCORPORATED UNDER THE COMPANIES ACT, 1956, OF THE ABOVE ADDRESS			
DATE OF REGISTRATION	03/09/2013		
TITLE	BOTTLE		
PRIORITY NA			
DESIGN NUMBER	259101		
CLASS	06-11		
1)HONDA ACCESS CORP., OF 18-4, 8-CHOME, NOBIDOME, NIIZA-SHI, SAITAMA, JAPAN			
DATE OF REGISTRATION	30/12/2013		
TITLE	FLOOR MAT FOR VEHICLE		
PRIORITY			
PRIORITY NUMBER	DATE	COUNTRY	
2013-016440	19/07/2013	JAPAN	
DESIGN NUMBER	259513		
CLASS	11-02		
1)AMAR SINGH YADAV, TRADING AS M/S. S. N. GLASS DECORATERS, SITUATED AT 2/778, SUHAG NAGAR, FIROZABAD (U.P.) INDIA, OF ABOVE ADDRESS			
DATE OF REGISTRATION	20/01/2014		
TITLE	FLOWER VASE		
PRIORITY NA			

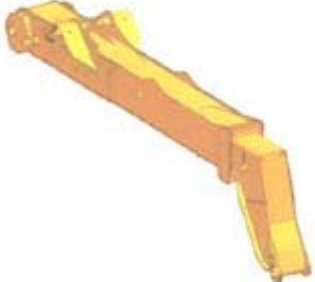
DESIGN NUMBER	255439	
CLASS	25-04	
1)DIRECTOR GENERAL, DEFENCE RESEARCH & DEVELOPMENT ORGANIZATION(DRDO), MINISTRY OF DEFENCE, GOVT. OF INDIA, ROOM NO. 348, B-WING, DRDO BHAVAN, RAJAJI MARG, NEW DELHI-110105, INDIA		
DATE OF REGISTRATION	26/07/2013	
TITLE	CENTRAL DECK FOR MOUNTAIN FOOTBRIDGE	
PRIORITY NA		
DESIGN NUMBER	259823	
CLASS	12-16	
1)BAJAJ AUTO LIMITED, AN INDIAN COMPANY, INCORPORATED UNDER THE COMPANIES ACT OF 1956, HAVING ITS PRINCIPAL PLACE OF BUSINESS AT NEW 2ND & 3RD FLOOR, KHIVRAJ BUILDING, NO. 616, ANNASALAI, CHENNAI - 600006, STATE OF TAMIL NADU, INDIA, AND REGISTERED OFFICE AT AKURDI, PUNE-411035, STATE OF MAHARASHTRA, INDIA		
DATE OF REGISTRATION	29/01/2014	
TITLE	WHEEL RIM FOR MOTORCYCLE	
PRIORITY NA		
DESIGN NUMBER	257819	
CLASS	12-16	
1)JCB INDIA LIMITED, AN INDIAN COMPANY HAVING ITS REGISTERED OFFICE AT B-1/1-1, 2ND FLOOR, MOHAN CO-OPERATIVE INDUSTRIAL ESTATE, MATHURA ROAD, NEW DELHI, INDIA AND WORKS AT 23/7, MATHURA ROAD, BALLABGARH, HARYANA, INDIA.		
DATE OF REGISTRATION	28/10/2013	
TITLE	BOOM OF TELESCOPIC HANDLER (LOADALL)	
PRIORITY NA		

DESIGN NUMBER	254621	
CLASS	12-08	
1)DONGFENG COMMERCIAL VEHICLE CO., LTD. A COMPANY INCORPORATED UNDER THE LAWS OF CHINA, NATIONALITY: CHINA, ADDRESS AT, NO. 2, WEST CHECHENG ROAD, ZHANGWAN DISTRICT, SHIYAN, HUBEI 442001 CHINA		
DATE OF REGISTRATION	20/06/2013	
TITLE	TRUCK	
PRIORITY		
PRIORITY NUMBER	DATE	COUNTRY
201230654080.4	26/12/2012	CHINA





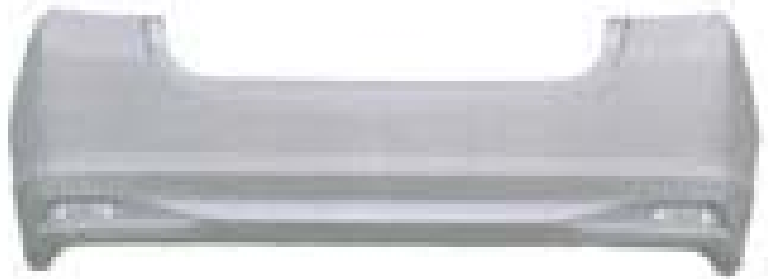



DESIGN NUMBER	258895	
CLASS	12-16	
1)HONDA MOTOR CO., LTD., A JAPANESE CORPORATION, OF 1-1, MINAMI-AOYAMA 2-CHOME, MINATO-KU, TOKYO, 107-8556, JAPAN		
DATE OF REGISTRATION	20/12/2013	
TITLE	REAR BUMPER FOR AUTOMOBILE	
PRIORITY		
PRIORITY NUMBER	DATE	COUNTRY
2013-014751	28/06/2013	JAPAN





DESIGN NUMBER	258425	
CLASS	15-07	
1)VISHKARMA ENTERPRISES, AN INDIAN COMPANY, OF THE ADDRESS B-14, SANJAY COLONY, SECTOR 22, FARIDABAD-121005, INDIA		
DATE OF REGISTRATION	28/11/2013	
TITLE	LOCKING DEVICE FOR REFRIGERATORS	
PRIORITY NA		



DESIGN NUMBER	258619	
CLASS	08-06	
1)(1) SURESHBHAI NAGJIBHAI VAGHASIYA (2) MAHESHBHAI DAHYABHAI SINGHALA (3) JAGDISHBHAI DAMJIBHAI VAGHASIYA (ALL THE PARTNERS ARE ADULT & INDIAN NATIONAL) PARTNERS OF AAI SHREE KHODIYAR (INDIAN PARTNERSHIP FIRM) HAVING PLACE OF BUSINESS AT: 4, SHREE HARI INDUSTRIAL ZONE, AJI RING ROAD, OPP: INDICA BOTTLING N.H. 8B, RAJKOT-GUJARAT-(INDIA)		
DATE OF REGISTRATION	09/12/2013	
TITLE	HANDLE	
PRIORITY NA		
DESIGN NUMBER	259511	
CLASS	11-02	
1)AMAR SINGH YADAV, TRADING AS M/S. S. N. GLASS DECORATERS, SITUATED AT 2/778, SUHAG NAGAR, FIROZABAD (U.P.) INDIA, OF ABOVE ADDRESS		
DATE OF REGISTRATION	20/01/2014	
TITLE	FLOWER VASE	
PRIORITY NA		
DESIGN NUMBER	255437	
CLASS	25-04	
1)DIRECTOR GENERAL, DEFENCE RESEARCH & DEVELOPMENT ORGANIZATION(DRDO), MINISTRY OF DEFENCE, GOVT. OF INDIA, ROOM NO. 348, B-WING, DRDO BHAVAN, RAJAJI MARG, NEW DELHI-110105, INDIA		
DATE OF REGISTRATION	26/07/2013	
TITLE	CONNECTING RODE FOR MOUNTAIN FOOTBRIDGE	
PRIORITY NA		

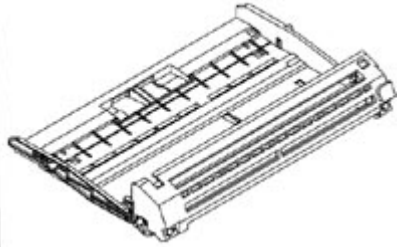
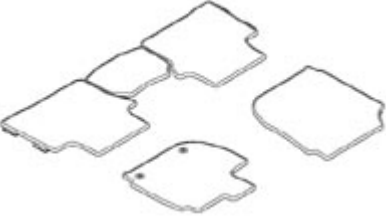

DESIGN NUMBER	259821		
CLASS	10-04		
1)BAJAJ AUTO LIMITED, AN INDIAN COMPANY, INCORPORATED UNDER THE COMPANIES ACT OF 1956, HAVING ITS PRINCIPAL PLACE OF BUSINESS AT NEW 2ND & 3RD FLOOR, KHIVRAJ BUILDING, NO. 616, ANNASALAI, CHENNAI - 600006, STATE OF TAMIL NADU, INDIA, AND REGISTERED OFFICE AT			
AKURDI, PUNE-411035, STATE OF MAHARASHTRA, INDIA			
DATE OF REGISTRATION	29/01/2014		
TITLE	SPEEDOMETER ASSEMBLY FOR MOTORCYCLE		
PRIORITY NA			
DESIGN NUMBER	257817		
CLASS	12-05		
1)JCB INDIA LIMITED, AN INDIAN COMPANY HAVING ITS REGISTERED OFFICE AT B-1/1-1, 2ND FLOOR, MOHAN CO-OPERATIVE INDUSTRIAL ESTATE, MATHURA ROAD, NEW DELHI, INDIA AND WORKS AT			
23/7, MATHURA ROAD, BALLABGARH, HARYANA, INDIA.			
DATE OF REGISTRATION	28/10/2013		
TITLE	TELESCOPIC HANDLER (LOADALL)		
PRIORITY NA			
DESIGN NUMBER	250677		
CLASS	12-16		
1)MAN TRUCK & BUS AG, A GERMAN COMPANY OF			
DACHAUER STR. 667, 80995 MUNICH, GERMANY			
DATE OF REGISTRATION	03/01/2013		
TITLE	FRONT BUMPER OF A UTILITY VEHICLE		
PRIORITY			
PRIORITY NUMBER	DATE	COUNTRY	
001335210	04/07/2012	OHIM	



DESIGN NUMBER	258215		
CLASS	16-03		
1)PANASONIC CORPORATION, A JAPANESE COMPANY ORGANIZED AND EXISTING UNDER THE LAWS OF JAPAN, OF 1006, OAZA KADOMA, KADOMA-SHI, OSAKA 571-8501, JAPAN			
DATE OF REGISTRATION	19/11/2013		
TITLE	CARTRIDGE		
PRIORITY			
PRIORITY NUMBER	DATE	COUNTRY	
2013-010979	20/05/2013	JAPAN	
DESIGN NUMBER	259105		
CLASS	06-11		
1)HONDA ACCESS CORP., OF 18-4, 8-CHOME, NOBIDOME, NIIZA-SHI, SAITAMA, JAPAN			
DATE OF REGISTRATION	30/12/2013		
TITLE	A SET OF FLOOR MATS FOR VEHICLE		
PRIORITY NA			
DESIGN NUMBER	255864		
CLASS	11-01		
1)BIREN VAIDYA, INDIAN NATIONAL, 131, 13TH FLOOR, VALLABH APARTMENTS, 87, BHULABHAI DESAI ROAD, MUMBAI-400026, MAHARASHTRA, INDIA			
DATE OF REGISTRATION	16/08/2013		
TITLE	RING		
PRIORITY NA			

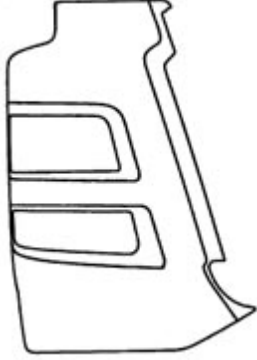

DESIGN NUMBER	259514	
CLASS	11-02	
1)AMAR SINGH YADAV, TRADING AS M/S. S. N. GLASS DECORATERS, SITUATED AT 2/778, SUHAG NAGAR, FIROZABAD (U.P.) INDIA, OF ABOVE ADDRESS		
DATE OF REGISTRATION	20/01/2014	
TITLE	FLOWER VASE	
PRIORITY NA		

DESIGN NUMBER	259580		
CLASS	23-01		
1)HANSGROHE SE, OF AUESTR. 5-9, D-77761 SCHILTACH, GERMANY, A GERMAN COMPANY			
DATE OF REGISTRATION	22/01/2014		
TITLE	SANITARY FAUCET		
PRIORITY			
PRIORITY NUMBER	DATE	COUNTRY	
001379093-0004	26/07/2013	OHIM	

DESIGN NUMBER	255440		
CLASS	25-04		
1)DIRECTOR GENERAL, DEFENCE RESEARCH & DEVELOPMENT ORGANIZATION(DRDO), MINISTRY OF DEFENCE, GOVT. OF INDIA, ROOM NO. 348, B-WING, DRDO BHAVAN, RAJAJI MARG, NEW DELHI-110105, INDIA			
DATE OF REGISTRATION	26/07/2013		
TITLE	FRAME FOR MOUNTAIN FOOTBRIDGE		
PRIORITY NA			

DESIGN NUMBER	259676		
CLASS	19-02		
1)KANGARO INDUSTRIES LIMITED AT B-XXX-6754, FOCAL POINT, LUDHIANA-141010, PUNJAB, INDIA, COMPANY INCORPORATED UNDER THE PROVISIONS OF INDIAN COMPANIES ACT HAVING THEIR ADDRESS OF B-XXX-6754, FOCAL POINT, LUDHIANA-141010, PUNJAB			
DATE OF REGISTRATION	27/01/2014		
TITLE	SCISSORS		
PRIORITY			
PRIORITY NUMBER	DATE	COUNTRY	
002367284	11/12/2013	OHIM	
DESIGN NUMBER	257990		
CLASS	12-16		
1)MAN TRUCK & BUS AG, A GERMAN COMPANY OF DACHAUER STRASSE 667, 80995 MÜNCHEN, GERMANY			
DATE OF REGISTRATION	06/11/2013		
TITLE	BUMPER FOR VEHICLES		
PRIORITY NA			
DESIGN NUMBER	258737		
CLASS	06-08		
1)SURAJ NEDIYAMBATHU (INDIAN) PROPRIETOR OF M/S S.S INDUSTRIES, EDAVOOR, KALADY, ERNAKULAM, PIN-683544, KERALA, INDIA			
DATE OF REGISTRATION	16/12/2013		
TITLE	CLOTHES HANGER		
PRIORITY NA			

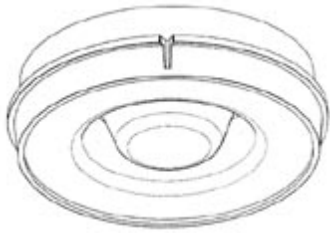

DESIGN NUMBER	255866		
CLASS	11-01		
1)BIREN VAIDYA, INDIAN NATIONAL, 131, 13TH FLOOR, VALLABH APARTMENTS, 87, BHULABHAI DESAI ROAD, MUMBAI-400026, MAHARASHTRA, INDIA			
DATE OF REGISTRATION	16/08/2013		
TITLE	EARRING SET		
PRIORITY NA			
DESIGN NUMBER	259367		
CLASS	09-01		
1)PEPSICO, INC., INCORPORATED IN NORTH CAROLINA OF 700 ANDERSON HILL ROAD, PURCHASE, NEW YORK 10577, UNITED STATES OF AMERICA			
DATE OF REGISTRATION	13/01/2014		
TITLE	BOTTLE		
PRIORITY			
PRIORITY NUMBER	DATE	COUNTRY	
29/460,550	11/07/2013	U.S.A.	
DESIGN NUMBER	259515		
CLASS	11-02		
1)AMAR SINGH YADAV, TRADING AS M/S. S. N. GLASS DECORATERS, SITUATED AT 2/778, SUHAG NAGAR, FIROZABAD (U.P.) INDIA, OF ABOVE ADDRESS			
DATE OF REGISTRATION	20/01/2014		
TITLE	FLOWER VASE		
PRIORITY NA			

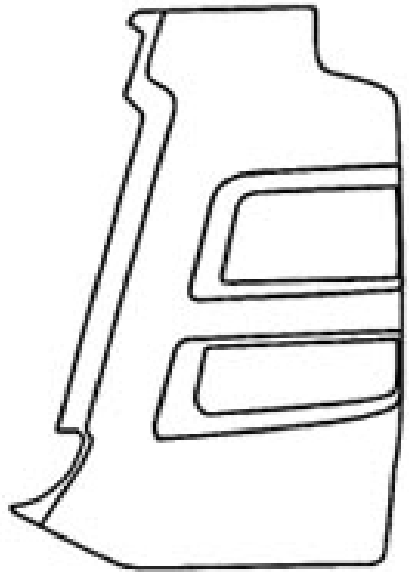

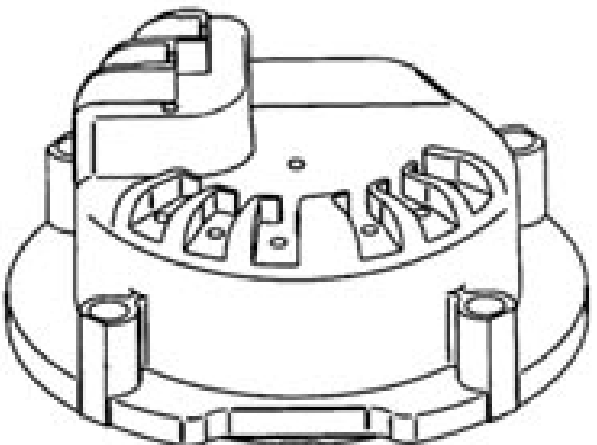
DESIGN NUMBER	257460		
CLASS	24-02		
1)VITROLIFE KFT., A COMPANY ORGANIZED AND EXISTING UNDER THE LAWS OF HUNGARY, HAVING PLACE OF BUSINESS AT GOGOL U. 9/B, SZEGED, 6722, HUNGARY			
DATE OF REGISTRATION	11/10/2013		
TITLE	CELL CULTURE DISH		
PRIORITY			
PRIORITY NUMBER	DATE	COUNTRY	
001369862-0002	25/04/2013	OHIM	
DESIGN NUMBER	255441		
CLASS	25-04		
1)DIRECTOR GENERAL, DEFENCE RESEARCH & DEVELOPMENT ORGANIZATION(DRDO), MINISTRY OF DEFENCE, GOVT. OF INDIA, ROOM NO. 348, B-WING, DRDO BHAVAN, RAJAJI MARG, NEW DELHI-110105, INDIA			
DATE OF REGISTRATION	26/07/2013		
TITLE	CLAMP FOR MOUNTAIN FOOTBRIDGE		
PRIORITY NA			
DESIGN NUMBER	259682		
CLASS	08-06		
1)MUKESHBHAI GORDHANBHAI RAKHOLIYA AN INDIAN NATIONAL SOLE PROPRIETOR OF RAMESHWAR METAL AN INDIAN PROPRIETORSHIP FIRM HAVING ITS PRINCIPAL PLACE OF BUSINESS AT 4, PARSANA SOCIETY, 50 FEET MAIN ROAD, B/H. 73 NO. SCHOOL, RAJKOT-360 002, GUJARAT - INDIA			
DATE OF REGISTRATION	27/01/2014		
TITLE	HANDLE		
PRIORITY NA			



DESIGN NUMBER	257991	
CLASS	12-16	
1)MAN TRUCK & BUS AG, A GERMAN COMPANY OF DACHAUER STRASSE 667, 80995 MÜNCHEN, GERMANY		
DATE OF REGISTRATION	06/11/2013	
TITLE	LEFT BUMPER FOR VEHICLES	
PRIORITY NA		

DESIGN NUMBER	258234	
CLASS	10-04	
1)ROSEMOUNT INC., A CORPORATION ORGANIZED AND EXISTING UNDER THE LAWS OF THE STATE OF MINNESOTA OF 8200 MARKET BOULEVARD, CHANHASSEN, MINNESOTA 55317, UNITED STATES OF AMERICA; NATIONALITY: U.S.A.		
DATE OF REGISTRATION	19/11/2013	
TITLE	TRANSMITTER PUCK FOR MEASURING TEMPERATURE	
PRIORITY		
PRIORITY NUMBER	DATE	COUNTRY
29/459,537	01/07/2013	U.S.A.

DESIGN NUMBER	259140	
CLASS	08-06	
1)GODREJ & BOYCE MFG. CO. LTD. OF LOCKS DIVISION (PLANT-18), PIROJSHANAGAR, VIKHROLI, MUMBAI - 400079, MAHARASHTRA, INDIA, INDIAN COMPANY		
DATE OF REGISTRATION	30/12/2013	
TITLE	HANDLE	
PRIORITY NA		

DESIGN NUMBER	258424			
CLASS	15-07			
1)VISHKARMA ENTERPRISES, AN INDIAN COMPANY, OF THE ADDRESS B-14, SANJAY COLONY, SECTOR 22, FARIDABAD-121005, INDIA				
DATE OF REGISTRATION	28/11/2013			
TITLE	LOCKING DEVICE FOR REFRIGERATORS			
PRIORITY NA				
DESIGN NUMBER	258564			
CLASS	06-01			
1)STEELCASE INC., 901-44TH STREET, S.E., GRAND RAPIDS, MICHIGAN 49508 USA, NATIONALITY: USA				
DATE OF REGISTRATION	05/12/2013			
TITLE	CHAIR			
PRIORITY				
PRIORITY NUMBER	DATE	COUNTRY		
29/457, 263	07/06/2013	U.S.A.		
DESIGN NUMBER	259510			
CLASS	11-02			
1)AMAR SINGH YADAV, TRADING AS M/S. S. N. GLASS DECORATERS, SITUATED AT 2/778, SUHAG NAGAR, FIROZABAD (U.P.) INDIA, OF ABOVE ADDRESS				
DATE OF REGISTRATION	20/01/2014			
TITLE	FLOWER VASE			
PRIORITY NA				

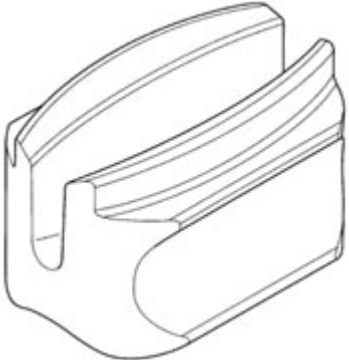

DESIGN NUMBER	255436		
CLASS	25-04		
1)DIRECTOR GENERAL, DEFENCE RESEARCH & DEVELOPMENT ORGANIZATION(DRDO), MINISTRY OF DEFENCE, GOVT. OF INDIA, ROOM NO. 348, B-WING, DRDO BHAVAN, RAJAJI MARG, NEW DELHI-110105, INDIA			
DATE OF REGISTRATION	26/07/2013		
TITLE	FRAME FOR MOUNTAIN FOOTBRIDGE		
PRIORITY NA			
DESIGN NUMBER	257816		
CLASS	12-16		
1)JCB INDIA LIMITED, AN INDIAN COMPANY HAVING ITS REGISTERED OFFICE AT B-1/1-1, 2ND FLOOR, MOHAN CO-OPERATIVE INDUSTRIAL ESTATE, MATHURA ROAD, NEW DELHI, INDIA AND WORKS AT 23/7, MATHURA ROAD, BALLABGARH, HARYANA, INDIA.			
DATE OF REGISTRATION	28/10/2013		
TITLE	CHASSIS OF TELESCOPIC HANDLER (LOADALL)		
PRIORITY NA			
DESIGN NUMBER	250676		
CLASS	12-16		
1)MAN TRUCK & BUS AG, A GERMAN COMPANY OF DACHAUER STR. 667, 80995 MUNICH, GERMANY			
DATE OF REGISTRATION	03/01/2013		
TITLE	FRONT BUMPER OF A UTILITY VEHICLE		
PRIORITY			
PRIORITY NUMBER	DATE	COUNTRY	
001335210	04/07/2012	OHIM	



DESIGN NUMBER	258209		
CLASS	07-02		
1) RAYES PLASTICWARE., (A PARTNERSHIP FIRM REGISTERED UNDER INDIAN PARTNERSHIP ACT, 1932), AT 1005, PINE WOOD, RAHEJA WILLOWS, AKURLI ROAD, KANDIVALI (EAST), MUMBAI-400101. MAHARASHTRA, INDIA. WHOSE PARTNERS ARE (1) MANISH KABRA. (INDIAN NATIONAL), & (2) MAHESH KUMAR KABRA. (INDIAN NATIONAL), ALL ARE HAVING ABOVE ADDRESS			
DATE OF REGISTRATION	19/11/2013		
TITLE	CASSEROLE		
PRIORITY NA			
DESIGN NUMBER	258998		
CLASS	28-03		
1) EYE COMFORT LIMITED, A COMPANY ORGANIZED AND EXISTING UNDER THE LAWS OF THE UNITED KINGDOM, OF 25-51 YORK STREET, BELFAST, COUNTRY ANTRIM BT15 1ED, NORTHERN IRELAND, UNITED KINGDOM			
DATE OF REGISTRATION	26/12/2013		
TITLE	APPLIANCE FOR MASSAGING THE EYELIDS		
PRIORITY			
PRIORITY NUMBER	DATE	COUNTRY	
002285494-0001	01/08/2013	OHIM	
DESIGN NUMBER	259516		
CLASS	11-02		
1) AMAR SINGH YADAV, TRADING AS M/S. S. N. GLASS DECORATORS, SITUATED AT 2/778, SUHAG NAGAR, FIROZABAD (U.P.) INDIA, OF ABOVE ADDRESS			
DATE OF REGISTRATION	20/01/2014		
TITLE	FLOWER VASE		
PRIORITY NA			

DESIGN NUMBER	255442	
CLASS	25-04	
1)DIRECTOR GENERAL, DEFENCE RESEARCH & DEVELOPMENT ORGANIZATION(DRDO), MINISTRY OF DEFENCE, GOVT. OF INDIA, ROOM NO. 348, B-WING, DRDO BHAVAN, RAJAJI MARG, NEW DELHI-110105, INDIA		
DATE OF REGISTRATION	26/07/2013	
TITLE	SPIKE FOR MOUNTAIN FOOTBRIDGE	
PRIORITY NA		

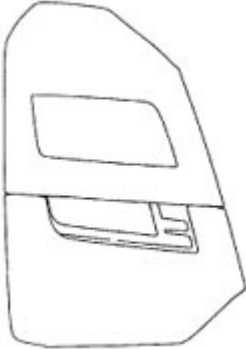
DESIGN NUMBER	259685	
CLASS	08-06	
1)BHARATBHAI BHURABHAI DOMADIA AND KALPESHBHAI VELJIBHAI DOMADIA BOTH INDIAN NATIONAL PARTNERS OF APEX TECHNO CAST AN INDIAN PARTNERSHIP FIRM HAVING ITS PRINCIPAL PLACE OF BUSINESS AT 5, AJI VASAHA, OPP. WESTERN MINERAL, 80 FEET ROAD, RAJKOT, GUJARAT-INDIA		
DATE OF REGISTRATION	27/01/2014	
TITLE	HANDLE	
PRIORITY NA		

DESIGN NUMBER	257822	
CLASS	16-05	
1)JANAK ARVINDBHAI MISTRY, 1, GANESH PARK-B, ADAJAN ROAD, SURAT 395009 IN THE STATE OF GUJARAT WITHIN THE UNION OF INDIA, WHO IS INDIAN BY NATIONALITY		
DATE OF REGISTRATION	28/10/2013	
TITLE	DIAMOND IMAGING APPARATUS	
PRIORITY NA		

DESIGN NUMBER	257993		
CLASS	12-16		
1)MAN TRUCK & BUS AG, A GERMAN COMPANY OF DACHAUER STRASSE 667, 80995 MÜNCHEN, GERMANY			
DATE OF REGISTRATION	06/11/2013		
TITLE	RIGHT BUMPER FOR VEHICLES		
PRIORITY NA			
DESIGN NUMBER	247765		
CLASS	09-03		
1)GLEN APPLIANCES PVT. LTD., I 34 DLF INDUSTRIAL AREA, PHASE 1, FARIDABAD INDIA, AN INDIAN COMPANY			
DATE OF REGISTRATION	10/09/2012		
TITLE	PACKAGING BOX		
PRIORITY NA			
DESIGN NUMBER	250683		
CLASS	12-16		
1)MAN TRUCK & BUS AG, A GERMAN COMPANY OF DACHAUER STR. 667, 80995 MUNICH, GERMANY			
DATE OF REGISTRATION	03/01/2013		
TITLE	FRONT BUMPER OF A UTILITY VEHICLE		
PRIORITY			
PRIORITY NUMBER	DATE	COUNTRY	
001335210	04/07/2012	OHIM	



DESIGN NUMBER	258904	
CLASS	23-01	
1)ASHIRVAD PIPES PVT. LTD, A COMPANY REGISTERED UNDER THE COMPANIES ACT 1956 HAVING ITS REGISTERED OFFICE AT 4-B, ATTIBELE INDUSTRIAL AREA, HOSUR ROAD, BANGALORE-562107, KARNATAKA, INDIA; NATIONALITY: INDIAN		
DATE OF REGISTRATION	20/12/2013	
TITLE	SEALING RING	
PRIORITY NA		
DESIGN NUMBER	259094	
CLASS	19-06	
1)K-NINE WRITING SYSTEMS PVT. LTD. (AN INDIAN PROPRIETORSHIP FIRM) UNIT NO: A-301/302, SUNFLOWER BUILDING, PLOT NO-36 A, SHIVNERI MARG, OFF GOREGAON-MULUND LINK ROAD, AMBEDKAR CHOWK, GOREGAON-EAST, MUMBAI-400063. STATE OF MAHARASHTRA, INDIA.		
DATE OF REGISTRATION	27/12/2013	
TITLE	PEN	
PRIORITY NA		
DESIGN NUMBER	259149	
CLASS	13-03	
1)AI-AZIZ PLASTICS PVT. LTD., (CO. REGISTERED) WHOSE ADDRESS 125, AMAR INDL. ESTATE, A. K. ROAD, SAKINAKA, ANDHERI-(E), MUMBAI-400072		
DATE OF REGISTRATION	31/12/2013	
TITLE	JUNCTION BOX	
PRIORITY NA		



DESIGN NUMBER	258426	
CLASS	15-07	
1)VISHKARMA ENTERPRISES, AN INDIAN COMPANY, OF THE ADDRESS B-14, SANJAY COLONY, SECTOR 22, FARIDABAD-121005, INDIA		
DATE OF REGISTRATION	28/11/2013	
TITLE	LOCKING DEVICE FOR REFRIGERATORS	
PRIORITY NA		
DESIGN NUMBER	258620	
CLASS	08-06	
1)(1) SURESHBHAI NAGJIBHAI VAGHASIYA (2) MAHESHBHAI DAHYABHAI SINGHALA (3) JAGDISHBHAI DAMJIBHAI VAGHASIYA (ALL THE PARTNERS ARE ADULT & INDIAN NATIONAL) PARTNERS OF AAI SHREE KHODIYAR (INDIAN PARTNERSHIP FIRM) HAVING PLACE OF BUSINESS AT: 4, SHREE HARI INDUSTRIAL ZONE, AJI RING ROAD, OPP: INDICA BOTTLING N.H. 8B, RAJKOT-GUJARAT-(INDIA)		
DATE OF REGISTRATION	09/12/2013	
TITLE	HANDLE	
PRIORITY NA		
DESIGN NUMBER	259512	
CLASS	11-02	
1)AMAR SINGH YADAV, TRADING AS M/S. S. N. GLASS DECORATERS, SITUATED AT 2/778, SUHAG NAGAR, FIROZABAD (U.P.) INDIA, OF ABOVE ADDRESS		
DATE OF REGISTRATION	20/01/2014	
TITLE	FLOWER VASE	
PRIORITY NA		



DESIGN NUMBER	255438	
CLASS	25-04	
1)DIRECTOR GENERAL, DEFENCE RESEARCH & DEVELOPMENT ORGANIZATION(DRDO), MINISTRY OF DEFENCE, GOVT. OF INDIA, ROOM NO. 348, B-WING, DRDO BHAVAN, RAJAJI MARG, NEW DELHI-110105, INDIA		
DATE OF REGISTRATION	26/07/2013	
TITLE	DECK JOINING FOR MOUNTAIN FOOTBRIDGE	
PRIORITY NA		

DESIGN NUMBER	259662	
CLASS	09-01	
1)SANJAY GOSALIA AN INDIVIDUAL-INDIAN RESIDENT OF 9/15, MORJI VELJI BLD, 1ST FLR ROOM NO-30, DR. M.B. VELKAR STREET, (KALBAT LANE), KALBADEVI ROAD, MUMBAI-400002, MAHARASHTRA, INDIA		
DATE OF REGISTRATION	24/01/2014	
TITLE	BOTTLE	
PRIORITY NA		

DESIGN NUMBER	257818	
CLASS	12-16	
1)JCB INDIA LIMITED, AN INDIAN COMPANY HAVING ITS REGISTERED OFFICE AT B-1/1-1, 2ND FLOOR, MOHAN CO-OPERATIVE INDUSTRIAL ESTATE, MATHURA ROAD, NEW DELHI, INDIA AND WORKS AT 23/7, MATHURA ROAD, BALLABGARH, HARYANA, INDIA		
DATE OF REGISTRATION	28/10/2013	
TITLE	CAB OF TELESCOPIC HANDLER (LOADALL)	
PRIORITY NA		

DESIGN NUMBER	250678		
CLASS	12-16		
1)MAN TRUCK & BUS AG, A GERMAN COMPANY OF DACHAUER STR. 667, 80995 MUNICH, GERMANY			
DATE OF REGISTRATION	03/01/2013		
TITLE	FRONT BUMPER OF A UTILITY VEHICLE		
PRIORITY			
PRIORITY NUMBER	DATE	COUNTRY	
001335210	04/07/2012	OHIM	
DESIGN NUMBER	255907		
CLASS	16-06		
1)JORAN LUNDH C/O GOXS LIMITED SUITE 919, 9TH FLOOR, TOWER 333 CANTON ROAD HONG KONG CITY (KOWLOON), HONG KONG			
DATE OF REGISTRATION	19/08/2013		
TITLE	GLASSES		
PRIORITY			
PRIORITY NUMBER	DATE	COUNTRY	
002191346 -0001	26/02/2013	OHIM	
DESIGN NUMBER	255443		
CLASS	25-04		
1)DIRECTOR GENERAL, DEFENCE RESEARCH & DEVELOPMENT ORGANIZATION(DRDO), MINISTRY OF DEFENCE, GOVT. OF INDIA, ROOM NO. 348, B-WING, DRDO BHAVAN, RAJAJI MARG, NEW DELHI-110105, INDIA			
DATE OF REGISTRATION	26/07/2013		
TITLE	ANCHORING PLATE FOR MOUNTAIN FOOTBRIDGE		
PRIORITY NA			

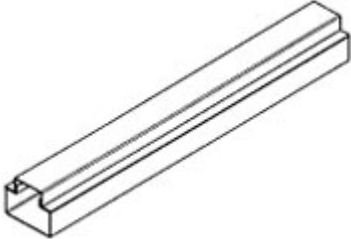
DESIGN NUMBER	257994		
CLASS	12-16		
1)MAN TRUCK & BUS AG, A GERMAN COMPANY OF DACHAUER STRASSE 667, 80995 MÜNCHEN, GERMANY			
DATE OF REGISTRATION	06/11/2013		
TITLE	LEFT BUMPER FOR VEHICLES		
PRIORITY NA			
DESIGN NUMBER	260283		
CLASS	23-04		
1)GREE ELECTRIC APPLIANCES, INC. OF ZHUHAI, A COMPANY DULY ORGANIZED AND EXISTING UNDER THE LAWS OF P.R. CHINA OF QIANSHAN JINJI WEST ROAD, ZHUHAI CITY, GUANGDONG 519070, P.R. CHINA			
DATE OF REGISTRATION	11/02/2014		
TITLE	AIR CONDITIONER		
PRIORITY			
PRIORITY NUMBER	DATE	COUNTRY	
201330398897.4	20/08/2013	CHINA	
DESIGN NUMBER	256664		
CLASS	09-01		
1)MAP OF THE HEART PTY LTD, OF THE ADDRESS SHOP 5, 1000-1008 PITTWATER ROAD, COLLAROY, NEW SOUTH WALES 2097, AUSTRALIA			
DATE OF REGISTRATION	20/09/2013		
TITLE	PERFUME BOTTLE		
PRIORITY			
PRIORITY NUMBER	DATE	COUNTRY	
348505	22/03/2013	AUSTRALIA	

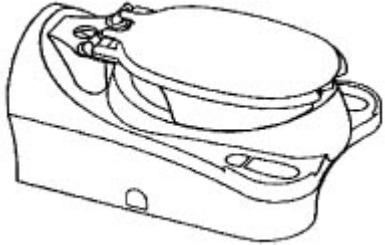
DESIGN NUMBER	254811	
CLASS	25-02	
1)UPPALAPATI VENKATESWARA RAO, WHOSE ADDRESS IS M/S RAMA INDUSTRIES, PLOT NO. 216, R. S. NO. 112, 4TH CROSS ROAD, KONDAPALLY INDUSTRIAL PARK, VIJAYAWADA RURAL-521228, KRISHNA DISTRICT, ANDHRA PRADESH, INDIA, AND WHOSE NATIONALITY IS INDIA		
DATE OF REGISTRATION	26/06/2013	
TITLE	FITTING ASSEMBLY FOR DOOR AND WINDOW	
PRIORITY NA		
DESIGN NUMBER	253753	
CLASS	06-05	
1)CARBORUNDUM UNIVERSAL LIMITED, AN INDIAN COMPANY OF PARRY HOUSE, 6TH FLOOR, NO. 43, MOORE STREET, CHENNAI 600001, INDIA		
DATE OF REGISTRATION	07/05/2013	
TITLE	COMPOSITE SPACE SAVING UNIT	
PRIORITY NA		
DESIGN NUMBER	258238	
CLASS	23-02	
1)CHERN EE PIN OF BLK 163, YUNG PING RD#17-84, SINGAPORE-610163		
DATE OF REGISTRATION	19/11/2013	
TITLE	WATER CLOSET	
PRIORITY NA		

DESIGN NUMBER	258853	
CLASS	19-02	
1)KANIN (INDIA) AT B-XXX-6754, FOCAL POINT, LUDHIANA-141010, PUNJAB, INDIA, AN INDIAN PARTNERSHIP FIRM, WHOSE PARTNERS ARE ARIHANT JAIN, VISHWA JAIN, MS. NEELAM JAIN, AMBRISH JAIN, GAUTAM JAIN AND AMIT JAIN (ALL INDIAN NATIONALS) HAVING THEIR ADDRESS OF B-XXX-6754, FOCAL POINT, LUDHIANA-141010, PUNJAB		
DATE OF REGISTRATION	19/12/2013	
TITLE	TACKER	
PRIORITY		
PRIORITY NUMBER	DATE	COUNTRY
002314989-0001	25/09/2013	OHIM





DESIGN NUMBER	259521	
CLASS	06-01	
1)THE SUPREME INDUSTRIES LTD., (AN INDIAN PUBLIC LIMITED COMPANY), 601 CENTRAL PLAZA, 2/6, SARAT BOSE ROAD, KOLKATA - 700020, WEST BENGAL, INDIA		
DATE OF REGISTRATION	20/01/2014	
TITLE	TABLE BASE	
PRIORITY NA		







DESIGN NUMBER	255445	
CLASS	25-04	
1)DIRECTOR GENERAL, DEFENCE RESEARCH & DEVELOPMENT ORGANIZATION(DRDO), MINISTRY OF DEFENCE, GOVT. OF INDIA, ROOM NO. 348, B-WING, DRDO BHAVAN, RAJAJI MARG, NEW DELHI-110105, INDIA		
DATE OF REGISTRATION	26/07/2013	
TITLE	LAUNCHING FRAME FOR MOUNTAIN FOOTBRIDGE	
PRIORITY NA		



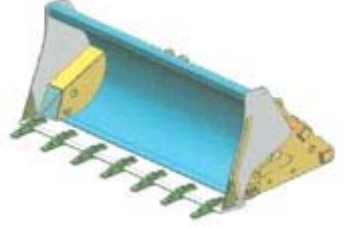

DESIGN NUMBER	256731		
CLASS	24-01		
1)PHOTOCURE ASA; A NORWEGIAN COMPANY OF HOFFSVEIEN 4, 0275 OSLO, NORWAY			
DATE OF REGISTRATION	24/09/2013		
TITLE	LIGHT TREATMENT APPARATUS FOR PHOTODYNAMIC TREATMENT OF CERVIX		
PRIORITY			
PRIORITY NUMBER	DATE	COUNTRY	
001368286	09/04/2013	OHIM	
DESIGN NUMBER	254813		
CLASS	25-02		
1)UPPALAPATI VENKATESWARA RAO, WHOSE ADDRESS IS M/S RAMA INDUSTRIES, PLOT NO. 216, R. S. NO. 112, 4TH CROSS ROAD, KONDAPALLY INDUSTRIAL PARK, VIJAYAWADA RURAL-521228, KRISHNA DISTRICT, ANDHRA PRADESH, INDIA, AND WHOSE NATIONALITY IS INDIA			
DATE OF REGISTRATION	26/06/2013		
TITLE	FITTING ASSEMBLY FOR DOOR AND WINDOW		
PRIORITY NA			
DESIGN NUMBER	258777		
CLASS	13-02		
1)M/S G. M. MODULAR PVT. LTD., 405/406, SHALIMAR MORYA PARK, BEHIND HYUNDAI SHOWROOM, ANDHERI (WEST), MUMBAI-400053., (INDIA)			
DATE OF REGISTRATION	17/12/2013		
TITLE	DOCK STATION FOR ELECTRONIC DEVICES		
PRIORITY NA			



DESIGN NUMBER	259525	
CLASS	05-05	
1)SATHEESAN V C/O AVID APPAREL INDUSTRIES, B-17, SECTOR-58 NOIDA-201301 (UP) INDIA, INDIAN		
DATE OF REGISTRATION	20/01/2014	
TITLE	TEXTILE FABRIC	
PRIORITY NA		
DESIGN NUMBER	255447	
CLASS	25-04	
1)DIRECTOR GENERAL, DEFENCE RESEARCH & DEVELOPMENT ORGANIZATION(DRDO), MINISTRY OF DEFENCE, GOVT. OF INDIA, ROOM NO. 348, B-WING, DRDO BHAVAN, RAJAJI MARG, NEW DELHI-110105, INDIA		
DATE OF REGISTRATION	26/07/2013	
TITLE	PUSHING ARRANGEMENT FOR MOUNTAIN FOOTBRIDGE	
PRIORITY NA		
DESIGN NUMBER	258012	
CLASS	08-06	
1)MR. TULESHBHAI DAYALJIBHAI PATEL., AN INDIAN NATIONAL., HAVING ITS PRINCIPAL PLACE OF BUSINESS AT, "KRISHNA", NR. ARYA DAIRY FARM, LEUVA PATEL BOARDING MAIN ROAD, MAVDI PLOT, RAJKOT. GUJARAT-INDIA		
DATE OF REGISTRATION	06/11/2013	
TITLE	HANDLE	
PRIORITY NA		



DESIGN NUMBER	258033	
CLASS	12-16	
1)JCB INDIA LIMITED, AN INDIAN COMPANY HAVING ITS REGISTERED OFFICE AT B-1/1-1, 2ND FLOOR, MOHAN CO-OPERATIVE INDUSTRIAL ESTATE, MATHURA ROAD, NEW DELHI, INDIA AND WORKS AT 23/7, MATHURA ROAD, BALLABGARH, HARYANA, INDIA.		
DATE OF REGISTRATION	07/11/2013	
TITLE	HIGH DUMP SHOVEL OF BACKHOE LOADER	
PRIORITY NA		
DESIGN NUMBER	255446	
CLASS	25-04	
1)DIRECTOR GENERAL, DEFENCE RESEARCH & DEVELOPMENT ORGANIZATION(DRDO), MINISTRY OF DEFENCE, GOVT. OF INDIA, ROOM NO. 348, B-WING, DRDO BHAVAN, RAJAJI MARG, NEW DELHI-110105, INDIA		
DATE OF REGISTRATION	26/07/2013	
TITLE	LOAD BEARING FRAME FOR MOUNTAIN FOOTBRIDGE	
PRIORITY NA		
DESIGN NUMBER	258032	
CLASS	12-16	
1)JCB INDIA LIMITED, AN INDIAN COMPANY HAVING ITS REGISTERED OFFICE AT B-1/1-1, 2ND FLOOR, MOHAN CO-OPERATIVE INDUSTRIAL ESTATE, MATHURA ROAD, NEW DELHI, INDIA AND WORKS AT 23/7, MATHURA ROAD, BALLABGARH, HARYANA, INDIA.		
DATE OF REGISTRATION	07/11/2013	
TITLE	CAB OF BACKHOE LOADER	
PRIORITY NA		

DESIGN NUMBER	258664	
CLASS	09-02	
1)SHANKER PLASTIC PRODUCTS, I.G.C. PHASE-I, SAMBA-184121 (J & K) INDIA AN INDIAN PROPRIETORSHIP FIRM WHOSE PROPRIETOR IS:- PARVEEN SHARMA BEING INDIAN NATIONALS OF THE ABOVE ADDRESS		
DATE OF REGISTRATION	11/12/2013	
TITLE	WATER TANK	
PRIORITY NA		

DESIGN NUMBER	258780	
CLASS	14-03	
1)M/S G. M. MODULAR PVT. LTD., 405/406, SHALIMAR MORYA PARK, BEHIND HYUNDAI SHOWROOM, ANDHERI (WEST), MUMBAI-400053., (INDIA)		
DATE OF REGISTRATION	17/12/2013	
TITLE	REMOTE CONTROL	
PRIORITY NA		

DESIGN NUMBER	258405	
CLASS	26-99	
1)EARTH FRIENDLY INDIA PVT. LTD., PLOT NO. 3-A, TIVIM INDUSTRIAL ESTATE, KARASWADA, MAPUSA, BARDEZ GOA-403507, INDIA		
DATE OF REGISTRATION	27/11/2013	
TITLE	LIGHTING APPARATUS	
PRIORITY NA		

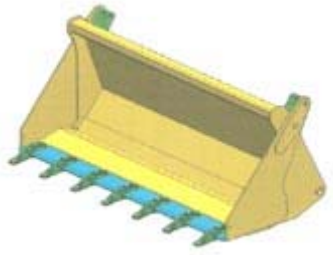
DESIGN NUMBER	254996		
CLASS	06-04		
1)GODREJ & BOYCE MFG. CO. LTD., AN INDIAN COMPANY INCORPORATED UNDER THE COMPANIES ACT, 1913, OF GODREJ INTERIO, PLANT 4, PIROJSHANAGER, VIKHROLI (WEST), MUMBAI-400079, INDIA			
DATE OF REGISTRATION	04/07/2013		
TITLE	CUPBOARD		
PRIORITY NA			
DESIGN NUMBER	255642		
CLASS	09-05		
1)SOCIÉTÉ DES PRODUITS NESTLÉ S.A. A COMPANY INCORPORATED UNDER THE LAWS OF THE SWITZERLAND HAVING ITS REGISTERED OFFICE AT 1800 VEVEY, SWITZERLAND			
DATE OF REGISTRATION	05/08/2013		
TITLE	CAPSULE FOR BEVERAGE DISPENSER		
PRIORITY			
PRIORITY NUMBER	DATE	COUNTRY	
139551	07/02/2013	SWITZERLAND	
DESIGN NUMBER	259893		
CLASS	12-08		
1)TATA MOTORS LIMITED, AN INDIAN COMPANY OF BOMBAY HOUSE, 24 HOMI MODY STREET, HUTATMA CHOWK, MUMBAI 400001, MAHARASHTRA, INDIA			
DATE OF REGISTRATION	31/01/2014		
TITLE	CAR		
PRIORITY NA			

DESIGN NUMBER	258034		
CLASS	12-16		
1)JCB INDIA LIMITED, AN INDIAN COMPANY HAVING ITS REGISTERED OFFICE AT B-1/1-1, 2ND FLOOR, MOHAN CO-OPERATIVE INDUSTRIAL ESTATE, MATHURA ROAD, NEW DELHI, INDIA AND WORKS AT 23/7, MATHURA ROAD, BALLABGARH, HARYANA, INDIA.			
DATE OF REGISTRATION	07/11/2013		
TITLE	MULTI PURPOSE SHOVEL OF BACKHOE LOADER		
PRIORITY NA			
DESIGN NUMBER	254484		
CLASS	24-02		
1)EPPENDORF AG, A BODY CORPORATE INCORPORATED UNDER THE LAWS OF GERMANY, HAVING ITS REGISTERED OFFICE AT BARKHAUSENWEG 1, DE-22339, HAMBURG, GERMANY			
DATE OF REGISTRATION	13/06/2013		
TITLE	BUCKET USED FOR CENTRIFUGE DEVICE		
PRIORITY			
PRIORITY NUMBER	DATE	COUNTRY	
402012005801.7	14/12/2012	GERMANY	
DESIGN NUMBER	255504		
CLASS	23-04		
1)KONINKLIJKE PHILIPS N.V., A COMPANY ORGANIZED AND EXISTING UNDER THE LAWS OF THE KINGDOM OF THE NETHERLANDS, RESIDING AT EINDHOVEN, WHOSE POST-OFFICE ADDRESS IS HIGH TECH CAMPUS 5, 5656 AE EINDHOVEN, THE NETHERLANDS			
DATE OF REGISTRATION	25/07/2013		
TITLE	AIR PURIFIER & HUMIDIFIER		
PRIORITY			
PRIORITY NUMBER	DATE	COUNTRY	
002190801-0001	25/02/2013	OHIM	

DESIGN NUMBER	259629		
CLASS	14-02		
1)SAMSUNG ELECTRONICS CO., LTD. 129, SAMSUNG-RO, YEONGTONG-GU, SUWON-SI, GYEONGGI-DO, 443-742, REPUBLIC OF KOREA, A COMPANY OF REPUBLIC OF KOREA			
DATE OF REGISTRATION	23/01/2014		
TITLE	TONER CARTRIDGE FOR COPY MACHINE		
PRIORITY			
PRIORITY NUMBER	DATE	COUNTRY	
30-2013-0038446	25/07/2013	REPUBLIC OF KOREA	
DESIGN NUMBER	255657		
CLASS	23-99		
1)SCIENCE FOR SOCIETY., REGISTERED UNDER THE SOCIETIES REGISTRATION ACT, 1860, AND HAVING OUR ADDRESS AT C/O. ADV. B.R.TIDKE, BEHIND BAHETI HOSPITAL, BANSILAL NAGAR, AMBAJOGAI, DIST. BEED-431517., MAHARASHTRA, INDIA			
DATE OF REGISTRATION	06/08/2013		
TITLE	SOLAR DRYER		
PRIORITY NA			
DESIGN NUMBER	258047		
CLASS	12-16		
1)JCB INDIA LIMITED, AN INDIAN COMPANY HAVING ITS REGISTERED OFFICE AT B-1/1-1, 2ND FLOOR, MOHAN CO-OPERATIVE INDUSTRIAL ESTATE, MATHURA ROAD, NEW DELHI, INDIA AND WORKS AT 23/7, MATHURA ROAD, BALLABGARH, HARYANA, INDIA.			
DATE OF REGISTRATION	08/11/2013		
TITLE	LOADER ARM FOR BACKHOE LOADER		
PRIORITY NA			

DESIGN NUMBER	255908	
CLASS	16-06	
1)JORAN LUNDH C/O GOXS LIMITED SUITE 919, 9TH FLOOR, TOWER 333 CANTON ROAD HONG KONG CITY (KOWLOON), HONG KONG		
DATE OF REGISTRATION	19/08/2013	
TITLE	GLASSES	
PRIORITY		
PRIORITY NUMBER	DATE	COUNTRY
002191346 -0005	26/02/2013	OHIM





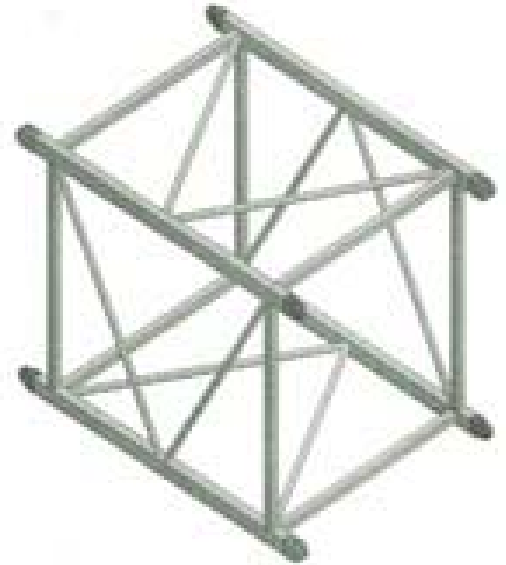

DESIGN NUMBER	255444	
CLASS	25-04	
1)DIRECTOR GENERAL, DEFENCE RESEARCH & DEVELOPMENT ORGANIZATION(DRDO), MINISTRY OF DEFENCE, GOVT. OF INDIA, ROOM NO. 348, B-WING, DRDO BHAVAN, RAJAJI MARG, NEW DELHI-110105, INDIA		
DATE OF REGISTRATION	26/07/2013	
TITLE	LAUNCHING BEAM PANEL FOR MOUNTAIN FOOTBRIDGE	
PRIORITY NA		





DESIGN NUMBER	260284	
CLASS	23-04	
1)GREE ELECTRIC APPLIANCES, INC. OF ZHUHAI, A COMPANY DULY ORGANIZED AND EXISTING UNDER THE LAWS OF P.R. CHINA OF QIANSHAN JINJI WEST ROAD, ZHUHAI CITY, GUANGDONG 519070, P.R. CHINA		
DATE OF REGISTRATION	11/02/2014	
TITLE	AIR CONDITIONER	
PRIORITY		
PRIORITY NUMBER	DATE	COUNTRY
201330547699.X	13/11/2013	CHINA

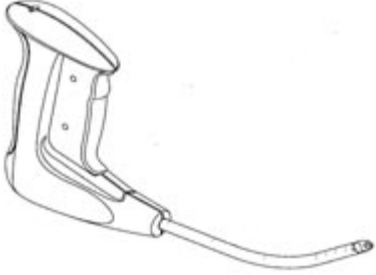

DESIGN NUMBER	254812	
CLASS	25-02	
1)UPPALAPATI VENKATESWARA RAO, WHOSE ADDRESS IS M/S RAMA INDUSTRIES, PLOT NO. 216, R. S. NO. 112, 4TH CROSS ROAD, KONDAPALLY INDUSTRIAL PARK, VIJAYAWADA RURAL-521228, KRISHNA DISTRICT, ANDHRA PRADESH, INDIA, AND WHOSE NATIONALITY IS INDIA		
DATE OF REGISTRATION	26/06/2013	
TITLE	FITTING ASSEMBLY FOR DOOR AND WINDOW	
PRIORITY NA		
DESIGN NUMBER	253754	
CLASS	06-05	
1)CARBORUNDUM UNIVERSAL LIMITED, AN INDIAN COMPANY OF PARRY HOUSE, 6TH FLOOR, NO. 43, MOORE STREET, CHENNAI 600 001, INDIA		
DATE OF REGISTRATION	07/05/2013	
TITLE	COMPOSITE SPACE SAVING UNIT	
PRIORITY NA		
DESIGN NUMBER	258239	
CLASS	23-02	
1)CHERN EE PIN OF BLK 163, YUNG PING RD#17-84, SINGAPORE-610163		
DATE OF REGISTRATION	19/11/2013	
TITLE	WATER CLOSET	
PRIORITY NA		

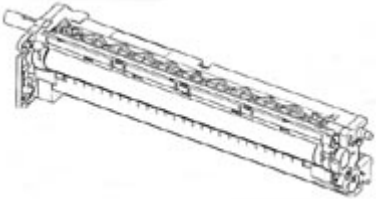
DESIGN NUMBER	256121		
CLASS	24-01		
1)ETHICON, INC., A CORPORATION FORMED UNDER THE LAW OF THE STATE OF NEW JERSEY, OF U.S. HWY. ROUTE 22, SOMERVILLE, NJ 08876, U.S.A.			
DATE OF REGISTRATION	30/08/2013		
TITLE	APPLICATOR INSTRUMENT FOR DISPENSING SURGICAL FASTENERS		
PRIORITY			
PRIORITY NUMBER	DATE	COUNTRY	
29/447,570	05/03/2013	U.S.A.	
DESIGN NUMBER	258607		
CLASS	12-11		
1)SWAPNIL BABURAO DHANDEKAR, HAVING ADDRESS, SR NO 36/2, SANJEEVANI NIVAS, KONDHWA BUDRUK, PUNE 411048. RAVINRA MARUTI TRIMBAKE, HAVING ADDRESS, SR NO 55, SAI NIVAS SOSITY BUNGLOW NO 11A, UNDRI PUNE 411048			
DATE OF REGISTRATION	06/12/2013		
TITLE	ELECTRIC BICYCLE		
PRIORITY NA			
DESIGN NUMBER	257261		
CLASS	12-16		
1)VOLVO LASTVAGNAR AB, OF 405 08 GÖTEBORG, SWEDEN			
DATE OF REGISTRATION	08/10/2013		
TITLE	FRONT PANEL FOR VEHICLE		
PRIORITY			
PRIORITY NUMBER	DATE	COUNTRY	
002219568-0004	12/04/2013	OHIM	

DESIGN NUMBER	257496			
CLASS	13-03			
1)NORMAN R. BYRNE (A CITIZEN OF UNITED STATES OF AMERICA) WHOSE ADDRESS IS 2736, HONEY GREEK AVE, NE ADA, MI 49301, UNITED STATES OF AMERICA				
DATE OF REGISTRATION	14/10/2013			
TITLE	ELECTRICAL POWER UNIT FOR A WORK SURFACE			
PRIORITY				
PRIORITY NUMBER	DATE	COUNTRY		
29/452,254	15/04/2013	U.S.A.		
DESIGN NUMBER	259630			
CLASS	14-02			
1)SAMSUNG ELECTRONICS CO., LTD. 129, SAMSUNG-RO, YEONGTONG-GU, SUWON-SI, GYEONGGI-DO, 443-742, REPUBLIC OF KOREA, A COMPANY OF REPUBLIC OF KOREA				
DATE OF REGISTRATION	23/01/2014			
TITLE	TONER CARTRIDGE FOR COPY MACHINE			
PRIORITY				
PRIORITY NUMBER	DATE	COUNTRY		
30-2013-0038443	25/07/2013	REPUBLIC OF KOREA		
DESIGN NUMBER	256259			
CLASS	09-01			
1)PEPSICO, INC., INCORPORATED IN NORTH CAROLINA OF 700 ANDERSON HILL ROAD, PURCHASE, NEW YORK 10577, UNITED STATES OF AMERICA				
DATE OF REGISTRATION	06/09/2013			
TITLE	CONTAINER-POD			
PRIORITY				
PRIORITY NUMBER	DATE	COUNTRY		
29/447,925	07/03/2013	U.S.A.		

DESIGN NUMBER	254499	
CLASS	22-01	
1)MAGPUL INDUSTRIES CORPORATION, 400 YOUNG COURT, UNIT 1, ERIE, COLORADO 80516, UNITED STATES OF AMERICA, A COLORADO CORPORATION		
DATE OF REGISTRATION	13/06/2013	
TITLE	RAIL COVER PANEL FOR A FIREARM	
PRIORITY		
PRIORITY NUMBER	DATE	COUNTRY
29/440,791	27/12/2012	U.S.A.



DESIGN NUMBER	258952	
CLASS	24-02	
1)MR. SACHIN G. LOKAPURE(INDIA). A PROPRIETOR OF SAGLO® RESEARCH EQUIPMENT HAVING ITS PRINCIPAL PLACE OF BUSINESS 5099, NEAR ASHA TALKIES, OPP. OMKAR APPT, SHANIWAR PETH, MIRAJ- 416410, DIST-SANGLI, MAHARASHTRA, INDIA		
DATE OF REGISTRATION	24/12/2013	
TITLE	MICROBIAL ELECTROLYSIS BATTERY	
PRIORITY NA		

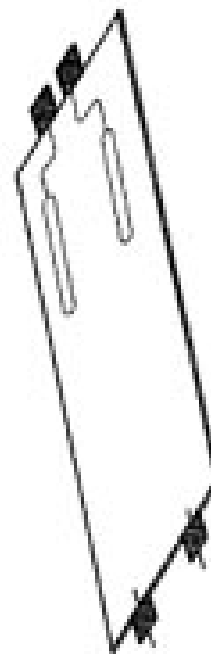

DESIGN NUMBER	258496	
CLASS	02-04	
1)JOSE JOSEPH, MAXY JOSEPH, SONIA TONY AND ABEY JOSEPH, TRADING IN PARTNERSHIP AS M/S. JOSCO RUBBERS, AT 8/50, MOONALINGAL, OPP. TO FIRE STATION, CALICUT-673032, KERALA, INDIA		
DATE OF REGISTRATION	29/11/2013	
TITLE	FOOTWEAR	
PRIORITY NA		



DESIGN NUMBER	259502		
CLASS	11-02		
1)AMAR SINGH YADAV, TRADING AS M/S. S. N. GLASS DECORATERS, SITUATED AT 2/778, SUHAG NAGAR, FIROZABAD (U.P.) INDIA, OF ABOVE ADDRESS			
DATE OF REGISTRATION	20/01/2014		
TITLE	FLOWER VASE		
PRIORITY NA			
DESIGN NUMBER	257271		
CLASS	26-06		
1)VOLVO LASTVAGNAR AB, OF 405 08 GÖTEBORG, SWEDEN			
DATE OF REGISTRATION	08/10/2013		
TITLE	HEADLAMP FOR VEHICLE		
PRIORITY			
PRIORITY NUMBER	DATE	COUNTRY	
002219600-0001	12/04/2013	OHIM	
DESIGN NUMBER	259632		
CLASS	23-01		
1)HANS GROHE SE, OF AUESTR. 5-9, D-77761 SCHILTACH, GERMANY, A GERMAN COMPANY			
DATE OF REGISTRATION	23/01/2014		
TITLE	SANITARY FAUCET		
PRIORITY			
PRIORITY NUMBER	DATE	COUNTRY	
001379093-0002	26/07/2013	OHIM	



DESIGN NUMBER	257759		
CLASS	12-16		
1)JCB INDIA LIMITED, AN INDIAN COMPANY HAVING ITS REGISTERED OFFICE AT B-1/1-1, 2ND FLOOR, MOHAN CO-OPERATIVE INDUSTRIAL ESTATE, MATHURA ROAD, NEW DELHI, INDIA AND WORKS AT 23/7, MATHURA ROAD, BALLABGARH, HARYANA, INDIA			
DATE OF REGISTRATION	25/10/2013		
TITLE	BOOM FOR SKID STEER LOADER		
PRIORITY NA			
DESIGN NUMBER	257941		
CLASS	15-07		
1)PRADEEPKUMAR NANDLAL DHOOT, INDIAN NATIONAL OF GANGAPURWALA, 2275 ADAT BAZAR, AHMEDNAGAR-414 001, MAHARASHTRA, INDIA.			
DATE OF REGISTRATION	01/11/2013		
TITLE	REFRIGERATOR		
PRIORITY NA			
DESIGN NUMBER	258149		
CLASS	24-02		
1)DEPUY (IRELAND), OF LOUGHBEG INDUSTRIAL ESTATE, RINGASKIDDY, CO CORK, IRELAND			
DATE OF REGISTRATION	14/11/2013		
TITLE	ORTHOPAEDIC SURGICAL INSTRUMENT		
PRIORITY			
PRIORITY NUMBER	DATE	COUNTRY	
29/457,168	07/06/2013	U.S.A.	



DESIGN NUMBER	256122		
CLASS	24-01		
1)ETHICON, INC., A CORPORATION FORMED UNDER THE LAW OF THE STATE OF NEW JERSEY, OF U.S. HWY. ROUTE 22, SOMERVILLE, NJ 08876, U.S.A.			
DATE OF REGISTRATION	30/08/2013		
TITLE	TIP OF SURGICAL APPLICATOR INSTRUMENT		
PRIORITY			
PRIORITY NUMBER	DATE	COUNTRY	
29/447,579	05/03/2013	U.S.A.	
DESIGN NUMBER	254496		
CLASS	22-01		
1)MAGPUL INDUSTRIES CORPORATION, 400 YOUNG COURT, UNIT 1, ERIE, COLORADO 80516, UNITED STATES OF AMERICA, A COLORADO CORPORATION			
DATE OF REGISTRATION	13/06/2013		
TITLE	RAIL COVER PANEL FOR A FIREARM		
PRIORITY			
PRIORITY NUMBER	DATE	COUNTRY	
29/440,345	20/12/2012	U.S.A.	
DESIGN NUMBER	259449		
CLASS	09-04		
1)ENRICH PLASTIC BAZAR., (A PARTNERSHIP FIRM REGISTERED UNDER INDIAN PARTNERSHIP ACT, 1932), AT SHOP NO. 2/3, MARKAZ VIEW CHS LTD., 137-139, S. V. ROAD, JOGESHWARI (WEST), MUMBAI-400102. MAHARASHTRA, INDIA. WHOSE PARTNERS ARE (1) BADRE ALAM SHAMSI. (INDIAN NATIONAL), (2) SAUD ALAM SHAMSI. (INDIAN NATIONAL), (3) TAHA ALAM SHAMSI. (INDIAN NATIONAL), (4) FAHD ALAM SHAMSI. (INDIAN NATIONAL) & (5) ASAD ALAM SHAMSI. (INDIAN NATIONAL), ALL ARE HAVING ABOVE ADDRESS			
DATE OF REGISTRATION	16/01/2014		
TITLE	BASKET		
PRIORITY NA			

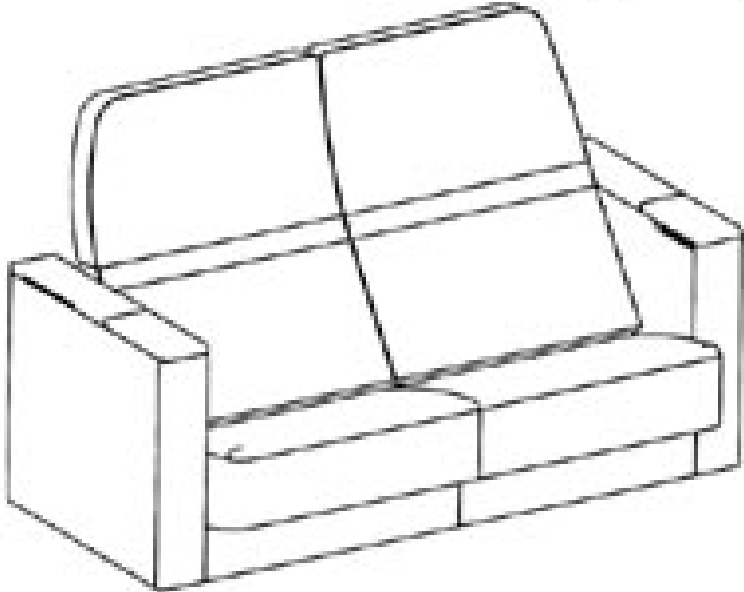

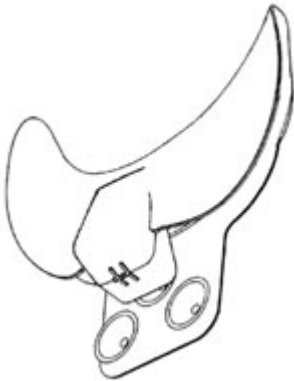
DESIGN NUMBER	259501	
CLASS	11-02	
1)AMAR SINGH YADAV, TRADING AS M/S. S. N. GLASS DECORATERS, SITUATED AT 2/778, SUHAG NAGAR, FIROZABAD (U.P.) INDIA, OF ABOVE ADDRESS		
DATE OF REGISTRATION	20/01/2014	
TITLE	FLOWER VASE	
PRIORITY NA		

DESIGN NUMBER	257262	
CLASS	12-16	
1)VOLVO LASTVAGNAR AB, OF 405 08 GÖTEBORG, SWEDEN		
DATE OF REGISTRATION	08/10/2013	
TITLE	FRONT PANEL FOR VEHICLE	
PRIORITY		
PRIORITY NUMBER	DATE	COUNTRY
002219568-0005	12/04/2013	OHIM

DESIGN NUMBER	257499	
CLASS	06-01	
1)ETIHAD AIRWAYS, A PRIVATE JOINT STOCK COMPANY ORGANIZED UNDER THE LAWS OF THE UAE, PO BOX 35566, NEW AIRPORT ROAD, ABU DHABI, UNITED ARAB EMIRATES.		
DATE OF REGISTRATION	14/10/2013	
TITLE	SEAT FOR VEHICLES	
PRIORITY		
PRIORITY NUMBER	DATE	COUNTRY
002220285	15/04/2013	EUROPEAN UNION

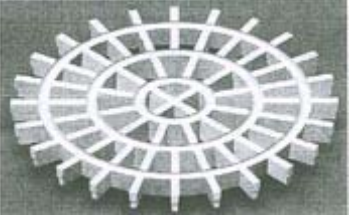
DESIGN NUMBER	258148		
CLASS	24-02		
1)DEPUY (IRELAND), OF LOUGHBEG INDUSTRIAL ESTATE, RINGASKIDDY, CO CORK, IRELAND			
DATE OF REGISTRATION	14/11/2013		
TITLE	ORTHOPAEDIC SURGICAL INSTRUMENT		
PRIORITY			
PRIORITY NUMBER	DATE	COUNTRY	
29/457,168	07/06/2013	U.S.A.	
DESIGN NUMBER	258504		
CLASS	28-03		
1)RIAMBEL PTY LTD, AN AUSTRALIAN COMPANY, OF 19 MARTON ROAD, BALCATT, WESTERN AUSTRALIA 6021, AUSTRALIA			
DATE OF REGISTRATION	29/11/2013		
TITLE	HEAD SUPPORT		
PRIORITY			
PRIORITY NUMBER	DATE	COUNTRY	
201312515	30/05/2013	AUSTRALIA	
DESIGN NUMBER	257295		
CLASS	14-01		
1)JVC KENWOOD CORPORATION, A BODY CORPORATE INCORPORATED UNDER THE LAWS OF JAPAN, HAVING ITS REGISTERED OFFICE AT 3-12, MORIYACHO, KANAGAWA-KU, YOKOHAMA-SHI, KANAGAWA, 221-0022, JAPAN			
DATE OF REGISTRATION	08/10/2013		
TITLE	DIGITAL VIDEO DISC PLAYER FOR VEHICLE		
PRIORITY			
PRIORITY NUMBER	DATE	COUNTRY	
2013-010491	14/05/2013	JAPAN	

DESIGN NUMBER	259503		
CLASS	11-02		
1)AMAR SINGH YADAV, TRADING AS M/S. S. N. GLASS DECORATERS, SITUATED AT 2/778, SUHAG NAGAR, FIROZABAD (U.P.) INDIA, OF ABOVE ADDRESS			
DATE OF REGISTRATION	20/01/2014		
TITLE	FLOWER VASE		
PRIORITY NA			
DESIGN NUMBER	259814		
CLASS	12-11		
1)BAJAJ AUTO LIMITED, AN INDIAN COMPANY, INCORPORATED UNDER THE COMPANIES ACT OF 1956, HAVING ITS PRINCIPAL PLACE OF BUSINESS AT NEW 2ND & 3RD FLOOR, KHIVRAJ BUILDING, NO. 616, ANNASALAI, CHENNAI - 600006, STATE OF TAMIL NADU, INDIA, AND REGISTERED OFFICE AT AKURDI, PUNE-411035, STATE OF MAHARASHTRA, INDIA			
DATE OF REGISTRATION	29/01/2014		
TITLE	GRAB HANDLE FOR MOTORCYCLE		
PRIORITY NA			
DESIGN NUMBER	256140		
CLASS	25-02		
1)BLÜCHER METAL A/S A COMPANY INCORPORATED UNDER THE LAWS OF DENMARK AND HAVING THEIR ADDRESS AT PUGDALVEJ 1, 7480 VILDBJERG, DENMARK			
DATE OF REGISTRATION	30/08/2013		
TITLE	GRATINGS FOR DRAINS		
PRIORITY			
PRIORITY NUMBER	DATE	COUNTRY	
002199984-001	11/03/2013	OHIM	

DESIGN NUMBER	254483		
CLASS	07-07		
1)EPPENDORF AG, A BODY CORPORATE INCORPORATED UNDER THE LAWS OF GERMANY, HAVING ITS REGISTERED OFFICE AT BARKHAUSENWEG 1, DE-22339, HAMBURG, GERMANY			
DATE OF REGISTRATION	13/06/2013		
TITLE	BUCKET USED FOR CENTRIFUGE DEVICE		
PRIORITY			
PRIORITY NUMBER	DATE	COUNTRY	
402012005801.7	14/12/2012	GERMANY	
DESIGN NUMBER	258407		
CLASS	26-99		
1)EARTH FRIENDLY INDIA PVT. LTD., PLOT NO. 3-A, TIVIM INDUSTRIAL ESTATE, KARASWADA, MAPUSA, BARDEZ GOA-403507, INDIA			
DATE OF REGISTRATION	27/11/2013		
TITLE	LIGHTING APPARATUS		
PRIORITY NA			
DESIGN NUMBER	255491		
CLASS	16-06		
1)PATRICK C. HO, A US CITIZEN, HAVING ITS OFFICE AT 4, QUAIL RUN, HILTON, NY 14468, UNITED STATES OF AMERICA			
DATE OF REGISTRATION	29/07/2013		
TITLE	EYEGLOSS FRAME		
PRIORITY			
PRIORITY NUMBER	DATE	COUNTRY	
29/444,327	29/01/2013	U.S.A.	

DESIGN NUMBER	259628	
CLASS	14-02	
1)SAMSUNG ELECTRONICS CO., LTD. 129, SAMSUNG-RO, YEONGTONG-GU, SUWON-SI, GYEONGGI-DO, 443-742, REPUBLIC OF KOREA, A COMPANY OF REPUBLIC OF KOREA		
DATE OF REGISTRATION	23/01/2014	
TITLE	TONER CARTRIDGE FOR COPY MACHINE	
PRIORITY		
PRIORITY NUMBER	DATE	COUNTRY
30-2013-0038445	25/07/2013	REPUBLIC OF KOREA

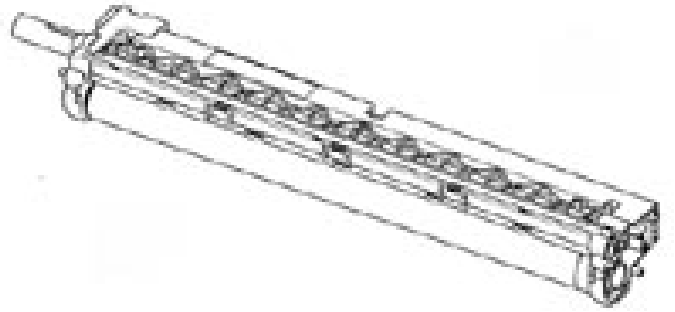

DESIGN NUMBER	259697	
CLASS	12-16	
1)HERO MOTOCORP LIMITED, AN INDIAN COMPANY INCORPORATED UNDER THE COMPANIES ACT, HAVING ITS OFFICE AT 34, COMMUNITY CENTRE, BASANT LOK, VASANT VIHAR, NEW DELHI-110057		
DATE OF REGISTRATION	27/01/2014	
TITLE	FAIRING FOR MOTORCYCLES	
PRIORITY NA		

DESIGN OF THE FAIRING FOR MOTORCYCLES
 HERO MOTOCORP LIMITED

Sheet No. 1/1









PERSPPECTIVE VIEW



DESIGN NUMBER	255652	
CLASS	08-06	
1)CHHANDRAKANTBHAI RANCHODBHAI RANGANI (INDIAN NATIONALS) SOLE PROPRIETOR OF DEV MARKETING (INDIAN PROPRIETORSHIP CONCERN) HAVING PLACE OF BUSINESS AT-NR. BHILAI WAY, BRIDGE FURNITURE STREET, JILLA GARDEN MAIN ROAD, BAPUNAGAR, RAJKOT-GUJARAT (INDIA)		
DATE OF REGISTRATION	06/08/2013	
TITLE	HANDLE	
PRIORITY NA		



DESIGN NUMBER	259404		
CLASS	26-04		
1)COOPER CROUSE-HINDS GMBH, A GERMAN COMPANY OF SENATOR-SCHWARTZ-RING 26, 59494 SOEST, GERMANY			
DATE OF REGISTRATION	15/01/2014		
TITLE	LED MODULE		
PRIORITY			
PRIORITY NUMBER	DATE	COUNTRY	
002274514	15/07/2013	OHIM	
DESIGN NUMBER	259505		
CLASS	11-02		
1)AMAR SINGH YADAV, TRADING AS M/S. S. N. GLASS DECORATERS, SITUATED AT 2/778, SUHAG NAGAR, FIROZABAD (U.P.) INDIA, OF ABOVE ADDRESS			
DATE OF REGISTRATION	20/01/2014		
TITLE	FLOWER VASE		
PRIORITY NA			
DESIGN NUMBER	257769		
CLASS	13-03		
1)DAIWA KASEI KOGYO KABUSHIKI KAISHA, A BODY CORPORATE INCORPORATED UNDER THE LAWS OF JAPAN, HAVING ITS REGISTERED OFFICE AT 1, AZA KAMIHIRACHI, HOBO-CHO, OKAZAKI-SHI, AICHI-KEN, JAPAN			
DATE OF REGISTRATION	25/10/2013		
TITLE	CLIP FOR WIREHARNESS OF VEHICLE		
PRIORITY			
PRIORITY NUMBER	DATE	COUNTRY	
2013-9502	26/04/2013	JAPAN	

DESIGN NUMBER	257944		
CLASS	15-07		
1)PRADEEPKUMAR NANDLAL DHOOT, INDIAN NATIONAL OF GANGAPURWALA, 2275 ADAT BAZAR, AHMEDNAGAR-414 001, MAHARASHTRA, INDIA.			
DATE OF REGISTRATION	01/11/2013		
TITLE	HANDLE FOR REFRIGERATOR		
PRIORITY NA			
DESIGN NUMBER	259405		
CLASS	26-04		
1)COOPER CROUSE-HINDS GMBH, A GERMAN COMPANY OF SENATOR-SCHWARTZ-RING 26, 59494 SOEST, GERMANY			
DATE OF REGISTRATION	15/01/2014		
TITLE	LED MODULE		
PRIORITY			
PRIORITY NUMBER	DATE	COUNTRY	
002274514	15/07/2013	OHIM	
DESIGN NUMBER	259506		
CLASS	11-02		
1)AMAR SINGH YADAV, TRADING AS M/S. S. N. GLASS DECORATERS, SITUATED AT 2/778, SUHAG NAGAR, FIROZABAD (U.P.) INDIA, OF ABOVE ADDRESS			
DATE OF REGISTRATION	20/01/2014		
TITLE	FLOWER VASE		
PRIORITY NA			

DESIGN NUMBER	259643		
CLASS	03-03		
1)TYNOR ORTHOTICS PVT. LTD., A COMPANY INCORPORATED UNDER THE COMPANIES ACT, 1956, HAVING ADDRESS AT D-111, INDUSTRIAL AREA, PHASE-7, MOHALI-160055, PUNJAB, INDIA			
DATE OF REGISTRATION	24/01/2014		
TITLE	UNDER ARM PAD FOR CRUTCH		
PRIORITY NA			
DESIGN NUMBER	257804		
CLASS	08-07		
1)BHARAT HEAVY ELECTRICALS LIMITED, WITH ONE OF ITS REGIONAL OFFICES AT REGIONAL OPERATIONS DIVISION (ROD), PLOT NO. 9/1, DJ BLOCK, 3RD FLOOR, KARUNAMOYEE, SLAT LAKE CITY, KOLKATA-700091, HAVING ITS REGISTERED OFFICE AT BHEL HOUSE SIRI FORT, NEW DELHI-110049, INDIA, AN INDIAN COMPANY.			
DATE OF REGISTRATION	28/10/2013		
TITLE	LOCKING DEVICE FOR HYDRAULIC BUTTERFLY VALVES		
PRIORITY NA			
DESIGN NUMBER	257954		
CLASS	08-09		
1)KYOSHIN KOGYO CO., LTD, A CORPORATION INCORPORATED UNDER THE LAWS OF JAPAN, HAVING ITS OFFICE AT 20-7, EBIE 7-CHOME, FUKUSHIMA-KU, OSAKA-SHI, OSAKA, JAPAN			
DATE OF REGISTRATION	04/11/2013		
TITLE	COLLET CHUCK FOR PIPE EXPANDER		
PRIORITY			
PRIORITY NUMBER	DATE	COUNTRY	
30-2013-0023154	02/05/2013	REPUBLIC OF KOREA	

DESIGN NUMBER	256900		
CLASS	26-04		
1)KONINKLIJKE PHILIPS N.V., A COMPANY ORGANIZED AND EXISTING UNDER THE LAWS OF THE KINGDOM OF THE NETHERLANDS, RESIDING AT EINDHOVEN, WHOSE POST-OFFICE ADDRESS IS HIGH TECH CAMPUS 5, 5656 AE EINDHOVEN, THE NETHERLANDS			
DATE OF REGISTRATION	30/09/2013		
TITLE	LED BULB		
PRIORITY			
PRIORITY NUMBER	DATE	COUNTRY	
002242891-0002	23/05/2013	OHIM	
DESIGN NUMBER	250670		
CLASS	12-16		
1)MAN TRUCK & BUS AG, A GERMAN COMPANY OF DACHAUER STR. 667, 80995 MUNICH, GERMANY			
DATE OF REGISTRATION	03/01/2013		
TITLE	FRONT BUMPER OF A UTILITY VEHICLE		
PRIORITY			
PRIORITY NUMBER	DATE	COUNTRY	
001335210	04/07/2012	OHIM	
DESIGN NUMBER	256331		
CLASS	24-04		
1)PATEL JAGDISH M., B-209, SHREEJI APPT., K.K. NAGAR-UMIYA HALL ROAD, GHATLODIYA, AHMEDABAD-380061			
DATE OF REGISTRATION	10/09/2013		
TITLE	THROAT SPRAYER		
PRIORITY NA			