

## ***CONTINUED FROM PART- 1***

### **INTRODUCTION**

In view of the recent amendment made in the Designs (Amendment) Rules, 2008 with effect from 17/06/2008, Publication of the matter relating to Designs is being published in the Official Journal of The Patent Office. This Journal is being published on weekly basis on every Friday covering the various proceedings on Designs as required according to the provisions of under Rule 22, 25, 27 and 39 of the Design (Amendment) Rules, 2008. All the enquiries on this Official Journal and other information as required by the public should be addressed to the Controller General of Patents, Designs & Trade Marks. Suggestions and comments are requested from all quarters so that the content can be enriched.

## COPYRIGHT PUBLICATION

<b>SL NO</b>	<b>REGISTERED DESIGN NUMBERS</b>	<b>RENEWED ON</b>
1.	186371	14.08.2014
2.	192966	25.07.2014
3.	186015	18.08.2014
4.	203425	14.08.2014
5.	190667	18.08.2014
6.	191903	14.08.2014
7.	190661	01.08.2014
8.	204723	18.08.2014
9.	205344	18.08.2014
10.	188805	25.07.2014
11.	190662	25.07.2014
12.	190663	25.07.2014
13.	190664	25.07.2014
14.	190666	14.08.2014
15.	195311	18.08.2014
16.	196018	14.08.2014
17.	204708	14.08.2014
18.	204707	14.08.2014
19.	204705	18.08.2014
20.	190669	13.08.2014
21.	190668	18.08.2014
22.	195176	25.07.2014

**THE DESIGNS ACT 2000**  
**SECTION 30**  
**DESIGN ASSIGNMENT**

**(01)**

The Design stands in the name of **MOTOROLA, INC** registered under the Designs Act, 2000 has been assigned in the Register of Designs in the name as follows:-

<b>Design No.</b>	<b>Class</b>	<b>Name</b>
<b>225304</b>	<b>14-03</b>	MOTOROLA MOBILITY, INC. OF, 600 NORTH US HIGHWAY 45, LIBERTYVILLE, IL 60048, USA, A DELAWARE CORPORATION

**(02)**

The Design stands in the name of **SARA LEE HOUSEHOLD AND BODY CARE NEDERLAND B.V.** registered under the Designs Act, 2000 has been assigned in the Register of Designs in the name as follows:-

<b>Design No.</b>	<b>Class</b>	<b>Name</b>
<b>210670</b>	<b>23-04</b>	SARA LEE HOUSEHOLD CARE NEDERLAND B.V OF, VLEUTENSEVAART 100, 3532 AD UTRECHT, THE NETHERLANDS, A DUTCH COMPANY

## REGISTRATION OF DESIGNS

The following designs have been registered. They are now open for public inspection. In the following each entry the Date of Registration is shown. The Priority Number, Priority Date and Priority Country are also shown

<b>DESIGN NUMBER</b>	257251		
<b>CLASS</b>	12-16		
<b>1)VOLVO LASTVAGNAR AB, OF 405 08 GÖTEBORG, SWEDEN</b>			
<b>DATE OF REGISTRATION</b>	08/10/2013		
<b>TITLE</b>	GRILLE FOR VEHICLE		
<b>PRIORITY</b>			
<b>PRIORITY NUMBER</b>	<b>DATE</b>	<b>COUNTRY</b>	
002219360-0007	12/04/2013	OHIM	
<b>DESIGN NUMBER</b>	257887		
<b>CLASS</b>	08-06		
<b>1)DIPAKBHAI BHIKHABHAI KHUNT (ADULT &amp; INDIAN NATIONAL) SOLE PROPRIETOR OF OM SAI MANUFACTURE (INDIAN PROPRIETORSHIP CONCERN) HAVING PLACE OF BUSINESS AT- 6/A, PARSANA SOCIETY, 50, FEET ROAD, SHREENATHJI PAN, RAJKOT-360 002-GUJARAT-(INDIA)</b>			
<b>DATE OF REGISTRATION</b>	31/10/2013		
<b>TITLE</b>	HANDLE		
<b>PRIORITY NA</b>			
<b>DESIGN NUMBER</b>	256896		
<b>CLASS</b>	08-06		
<b>1)SANVI ENTERPRISE, AN INDIAN ENTITY HAVING ITS PRINCIPAL PLACE OF BUSINESS AT NATIONAL HIGHWAY 8-B, OPP. PARIN FURNITURE, KOTHARIYA SOLVENT AREA, NEAR DHOKIYA MOTORS, KOTHARIYA, DIST: RAJKOT-360004, GUJARAT, INDIA</b>			
<b>DATE OF REGISTRATION</b>	30/09/2013		
<b>TITLE</b>	CABINET HANDLE		
<b>PRIORITY NA</b>			

<b>DESIGN NUMBER</b>	257260	
<b>CLASS</b>	12-16	
1)VOLVO LASTVAGNAR AB, OF 405 08 GÖTEBORG, SWEDEN		
<b>DATE OF REGISTRATION</b>	08/10/2013	
<b>TITLE</b>	GRILLE FOR VEHICLE	
<b>PRIORITY</b>		
<b>PRIORITY NUMBER</b>	<b>DATE</b>	<b>COUNTRY</b>
002219568-0003	12/04/2013	OHIM







<b>DESIGN NUMBER</b>	257410	
<b>CLASS</b>	12-16	
1)VOLVO LASTVAGNAR AB, OF SE 405 08 GÖTEBORG, SWEDEN		
<b>DATE OF REGISTRATION</b>	10/10/2013	
<b>TITLE</b>	ROOF AIR DEFLECTOR FOR VEHICLES	
<b>PRIORITY</b>		
<b>PRIORITY NUMBER</b>	<b>DATE</b>	<b>COUNTRY</b>
2013/0161	11/04/2013	SWEDEN

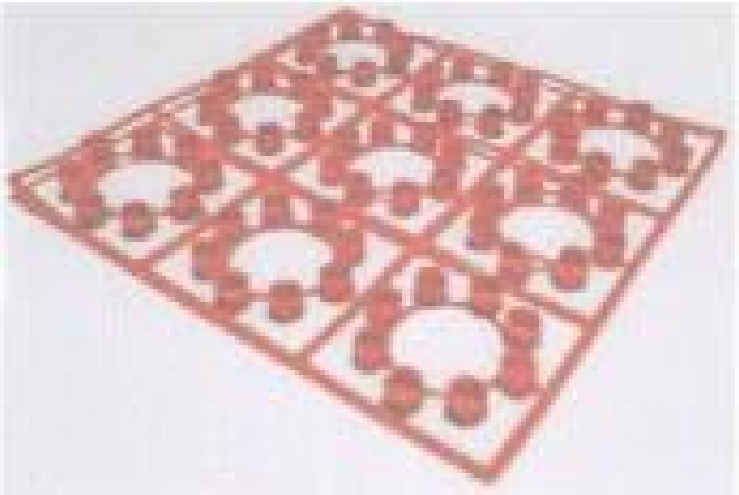

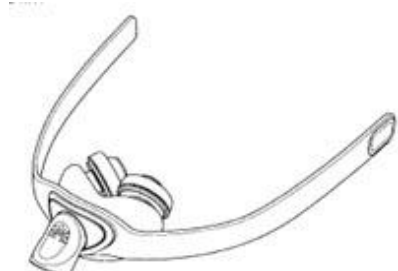
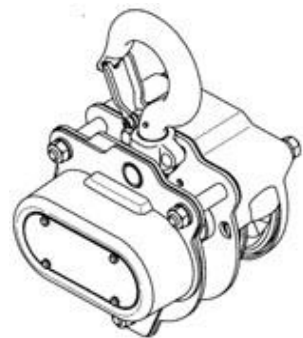
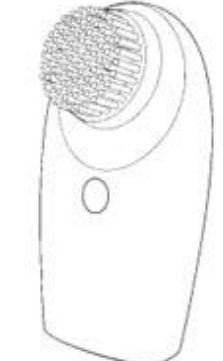

<b>DESIGN NUMBER</b>	257234	
<b>CLASS</b>	21-01	
1)S. M. TRADING CO., AN INDIAN PROPRIETORSHIP FIRM WHOSE PROPRIETOR IS MR. SATISH MANOCHA OF SHOP NO. 101, RANI JHANSI ROAD (RIGHT SIDE), DELHI 110 055, INDIA		
<b>DATE OF REGISTRATION</b>	07/10/2013	
<b>TITLE</b>	CAP FOR TOY PISTOL	
<b>PRIORITY NA</b>		

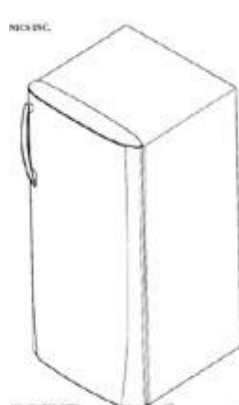

<b>DESIGN NUMBER</b>	257828		
<b>CLASS</b>	24-02		
<b>1)KONINKLIJKE PHILIPS N.V., A COMPANY ORGANIZED AND EXISTING UNDER THE LAWS OF THE KINGDOM OF THE NETHERLANDS, RESIDING AT EINDHOVEN,</b> WHOSE POST-OFFICE ADDRESS IS HIGH TECH CAMPUS 5, 5656 AE EINDHOVEN, THE NETHERLANDS			
<b>DATE OF REGISTRATION</b>	29/10/2013		
<b>TITLE</b>	PATIENT INTERFACE ASSEMBLY FOR RESPIRATORY THERAPY		
<b>PRIORITY</b>			
PRIORITY NUMBER	DATE	COUNTRY	
002233619-0004	07/05/2013	OHIM	
<b>DESIGN NUMBER</b>	251497		
<b>CLASS</b>	12-05		
<b>1)KITO CORPORATION, A JAPANESE CORPORATION OF</b> 2000, TSUIJIARAI, SHOWA-CHO, NAKAKOMA-GUN, YAMANASHI, 409-3853, JAPAN			
<b>DATE OF REGISTRATION</b>	07/02/2013		
<b>TITLE</b>	CHAIN HOIST		
<b>PRIORITY</b>			
PRIORITY NUMBER	DATE	COUNTRY	
2012-019242	09/08/2012	JAPAN	
<b>DESIGN NUMBER</b>	259177		
<b>CLASS</b>	28-03		
<b>1)KONINKLIJKE PHILIPS N.V., A COMPANY ORGANIZED AND EXISTING UNDER THE LAWS OF THE KINGDOM OF THE NETHERLANDS, RESIDING AT EINDHOVEN, WHOSE POST-OFFICE ADDRESS IS</b> HIGH TECH CAMPUS 5, 5656 AE EINDHOVEN, THE NETHERLANDS			
<b>DATE OF REGISTRATION</b>	02/01/2014		
<b>TITLE</b>	FACIAL CLEANSING BRUSH		
<b>PRIORITY</b>			
PRIORITY NUMBER	DATE	COUNTRY	
002280313-0002	24/07/2013	OHIM	

<b>DESIGN NUMBER</b>	258671	
<b>CLASS</b>	12-11	
<b>1)TVS MOTOR COMPANY LIMITED, AN INDIAN COMPANY INCORPORATED UNDER THE COMPANIES ACT, 1956, HAVING ITS REGISTERED OFFICE AT "JAYALAKSHMI ESTATES", 29 (OLD NO. 8) HADDOWS ROAD, CHENNAI 600 006, TAMIL NADU, INDIA</b>		
<b>DATE OF REGISTRATION</b>	11/12/2013	
<b>TITLE</b>	MOTORCYCLE	
<b>PRIORITY NA</b>		
<b>DESIGN NUMBER</b>	258880	
<b>CLASS</b>	09-01	
<b>1)GODREJ CONSUMER PRODUCTS LIMITED, AN INDIAN COMPANY HAVING ITS REGISTERED OFFICE AT PIROJSHANAGAR, EASTERN EXPRESS HIGHWAY, VIKHROLI, MUMBAI-400079, STATE OF MAHARASHTRA, INDIA</b>		
<b>DATE OF REGISTRATION</b>	19/12/2013	
<b>TITLE</b>	SOAP DISPENSER	
<b>PRIORITY NA</b>		
<b>DESIGN NUMBER</b>	259578	
<b>CLASS</b>	05-05	
<b>1)PARRY MURRAY &amp; CO. LTD., COMPANY REGISTERED UNDER THE LAWS OF ENGLAND AND WALES, HAVING ITS PRINCIPAL PLACE OF BUSINESS AT 3RD FLOOR, SIMPSON HOUSE, 6 CHERRY ORCHARD ROAD, CROYDON, CRO 6BA, UNITED KINGDOM</b>		
<b>DATE OF REGISTRATION</b>	22/01/2014	
<b>TITLE</b>	TEXTILE FABRIC	
<b>PRIORITY NA</b>		

<b>DESIGN NUMBER</b>	259669	
<b>CLASS</b>	15-07	
<b>1) LG ELECTRONICS INC.</b> 128 YEOUNI-DAERO, YEONGDEUNGPO - GU, SEOUL 150 - 721, REPUBLIC OF KOREA A CORPORATION INCORPORATED UNDER THE LAWS OF THE REPUBLIC OF KOREA		
<b>DATE OF REGISTRATION</b>	24/01/2014	
<b>TITLE</b>	REFRIGERATOR	
<b>PRIORITY NA</b>		
<b>DESIGN NUMBER</b>	259812	
<b>CLASS</b>	12-11	
<b>1) BAJAJ AUTO LIMITED, AN INDIAN COMPANY, INCORPORATED UNDER THE COMPANIES ACT OF 1956, HAVING ITS PRINCIPAL PLACE OF BUSINESS AT NEW 2ND &amp; 3RD FLOOR, KHIVRAJ BUILDING, NO. 616, ANNASALAI, CHENNAI - 600006, STATE OF TAMIL NADU, INDIA, AND REGISTERED OFFICE AT</b> AKURDI, PUNE-411035, STATE OF MAHARASHTRA, INDIA		
<b>DATE OF REGISTRATION</b>	29/01/2014	
<b>TITLE</b>	SILENCER END CHAMBER FOR MOTORCYCLE	
<b>PRIORITY NA</b>		
<b>DESIGN NUMBER</b>	257584	
<b>CLASS</b>	26-05	
<b>1) M/S SHREE SANT KRIPA INTELLECTUAL, HAVING OFFICE AT</b> 7, AKSHAY COMPLEX, OFF. DHOLE PATIL ROAD, PUNE-411001, MAHARASHTRA, INDIA, AN INDIAN COMPANY		
<b>DATE OF REGISTRATION</b>	21/10/2013	
<b>TITLE</b>	CEILING FIXTURES FOR LAMPS	
<b>PRIORITY NA</b>		



<b>DESIGN NUMBER</b>	257245	
<b>CLASS</b>	12-16	
1)VOLVO LASTVAGNAR AB, OF 405 08 GÖTEBORG, SWEDEN		
<b>DATE OF REGISTRATION</b>	08/10/2013	
<b>TITLE</b>	FRONT PANEL FOR VEHICLE	
<b>PRIORITY</b>		
PRIORITY NUMBER	DATE	COUNTRY
002219360-0001	12/04/2013	OHIM





<b>DESIGN NUMBER</b>	259225	
<b>CLASS</b>	06-01	
1)QUADRIFOGLIO SISTEMI D'ARREDO S.P.A., OF VIA CORNARÈ, 12, 31040 MANSUE'. FRAZIONE BASALGHELLE - ITALY, AN ITALIAN JOINT STOCK COMPANY.		
<b>DATE OF REGISTRATION</b>	03/01/2014	
<b>TITLE</b>	CHAIR	
<b>PRIORITY</b>		
PRIORITY NUMBER	DATE	COUNTRY
TV2013O000027	10/07/2013	ITALY



<b>DESIGN NUMBER</b>	259317	
<b>CLASS</b>	12-11	
1)HONDA MOTOR CO., LTD., A JAPANESE CORPORATION, OF 1-1, MINAMI-AOYAMA 2-CHOME, MINATO-KU, TOKYO, 107-8556, JAPAN		
<b>DATE OF REGISTRATION</b>	10/01/2014	
<b>TITLE</b>	MOTOR SCOOTER	
<b>PRIORITY</b>		
PRIORITY NUMBER	DATE	COUNTRY
2013-016371	18/07/2013	JAPAN





<b>DESIGN NUMBER</b>	259565	
<b>CLASS</b>	02-02	
1)SWASTIKA GARMENTS OF 4, RAMKUMAR RAKSHIT LANE, KOLKATA-700007, WEST BENGAL, INDIA, AN INDIAN PROPRIETORSHIP FIRM WHOSE PROPRIETOR IS BRIJGOPAL MUNDHARA, AN INDIAN OF THE ABOVE ADDRESS		
<b>DATE OF REGISTRATION</b>	22/01/2014	
<b>TITLE</b>	GARMENT SET	
<b>PRIORITY NA</b>		

<b>DESIGN NUMBER</b>	259800	
<b>CLASS</b>	09-01	
1)PARIS PERFUMES & COSMETICS PVT LTD. AN INDIAN NATIONAL COMPANY INCORPORATED UNDER THE COMPANIES ACT 1956 BARODA-JAMBUSAR N. H. WAY ROAD, AT & PO. DABHASA, TA. PADRA-391440, DIST. BARODA (GUJARAT), INDIA.		
<b>DATE OF REGISTRATION</b>	29/01/2014	
<b>TITLE</b>	CONTAINER	
<b>PRIORITY NA</b>		

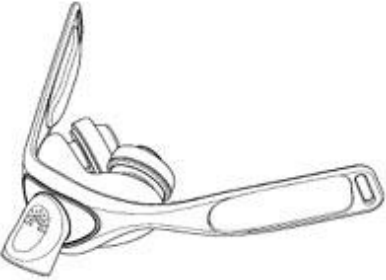
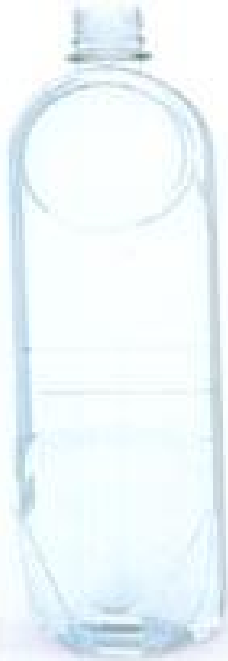
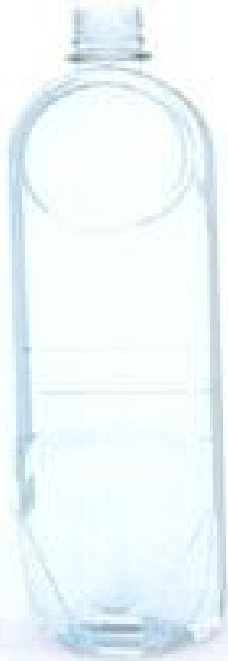
<b>DESIGN NUMBER</b>	257733	
<b>CLASS</b>	09-03	
1)VALEO SERVICE, A FRENCH COMPANY, OF 70 RUE PLEYEL, 93200 SAINT DENIS, FRANCE		
<b>DATE OF REGISTRATION</b>	24/10/2013	
<b>TITLE</b>	PACKAGING FOR WIPER BLADES AND THEIR PARTS	
<b>PRIORITY</b>		
<b>PRIORITY NUMBER</b>	<b>DATE</b>	<b>COUNTRY</b>
201330136192.5	24/04/2013	CHINA

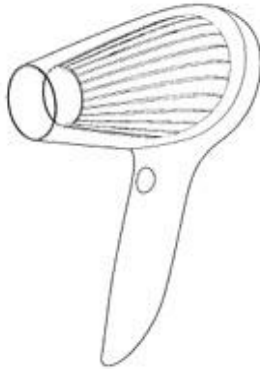
<b>DESIGN NUMBER</b>	257419		
<b>CLASS</b>	21-01		
1)VOLVO LASTVAGNAR AB, OF SE 405 08 GÖTEBORG, SWEDEN.			
<b>DATE OF REGISTRATION</b>	10/10/2013		
<b>TITLE</b>	TOY TRUCK CAB		
<b>PRIORITY</b>			
<b>PRIORITY NUMBER</b>	<b>DATE</b>	<b>COUNTRY</b>	
2013/0173	11/04/2013	SWEDEN	
<b>DESIGN NUMBER</b>	257827		
<b>CLASS</b>	24-02		
1)KONINKLIJKE PHILIPS N.V., A COMPANY ORGANIZED AND EXISTING UNDER THE LAWS OF THE KINGDOM OF THE NETHERLANDS, RESIDING AT EINDHOVEN, WHOSE POST-OFFICE ADDRESS IS HIGH TECH CAMPUS 5, 5656 AE EINDHOVEN, THE NETHERLANDS			
<b>DATE OF REGISTRATION</b>	29/10/2013		
<b>TITLE</b>	PATIENT INTERFACE ASSEMBLY FOR RESPIRATORY THERAPY		
<b>PRIORITY</b>			
<b>PRIORITY NUMBER</b>	<b>DATE</b>	<b>COUNTRY</b>	
002233619-0002	07/05/2013	OHIM	
<b>DESIGN NUMBER</b>	255357		
<b>CLASS</b>	09-01		
1)"RC02 WASHINGTON, INC.", HAVING NATIONALITY OF UNITED STATES OF AMERICA 701 FIFTH AVENUE, SUITE 4200 SEATTLE, WASHINGTON 98104 UNITED STATES OF AMERICA			
<b>DATE OF REGISTRATION</b>	19/07/2013		
<b>TITLE</b>	BOTTLE		
<b>PRIORITY</b>			
<b>PRIORITY NUMBER</b>	<b>DATE</b>	<b>COUNTRY</b>	
29/443,754	22/01/2013	U.S.A.	

<b>DESIGN NUMBER</b>	259176		
<b>CLASS</b>	28-03		
<b>1)KONINKLIJKE PHILIPS N.V., A COMPANY ORGANIZED AND EXISTING UNDER THE LAWS OF THE KINGDOM OF THE NETHERLANDS, RESIDING AT EINDHOVEN, WHOSE POST-OFFICE ADDRESS IS HIGH TECH CAMPUS 5, 5656 AE EINDHOVEN, THE NETHERLANDS</b>			
<b>DATE OF REGISTRATION</b>	02/01/2014		
<b>TITLE</b>	HAIR DRYER		
<b>PRIORITY</b>			
<b>PRIORITY NUMBER</b>	<b>DATE</b>	<b>COUNTRY</b>	
002280313-0001	24/07/2013	OHIM	
<b>DESIGN NUMBER</b>	259441		
<b>CLASS</b>	23-01		
<b>1)PRAKASHBHAI D. JARSANIYA., INDIAN NATIONALITY, SOLE PROPRIETOR OF M/S. ASHOK POLYMERS, INDIAN NATIONALITY, HAVING ADDRESS AT 4, SHREENATHJI ESTATE, NR. G.V.M.M., B/H. DEVBHUMI ESTATE, SINGARVA ROAD, ODHAV, AHMEDABAD-382430, GUJARAT STATE, INDIA</b>			
<b>DATE OF REGISTRATION</b>	16/01/2014		
<b>TITLE</b>	BALL VALVE		
<b>PRIORITY NA</b>			
<b>DESIGN NUMBER</b>	259532		
<b>CLASS</b>	05-05		
<b>1)SATHEESAN V C/O AVID APPAREL INDUSTRIES, B-17, SECTOR-58 NOIDA-201301 (UP) INDIA, INDIAN</b>			
<b>DATE OF REGISTRATION</b>	20/01/2014		
<b>TITLE</b>	TEXTILE FABRIC		
<b>PRIORITY NA</b>			

<b>DESIGN NUMBER</b>	259576	
<b>CLASS</b>	05-05	
<b>1)PARRY MURRAY &amp; CO. LTD., COMPANY REGISTERED UNDER THE LAWS OF ENGLAND AND WALES, HAVING ITS PRINCIPAL PLACE OF BUSINESS AT</b> 3RD FLOOR, SIMPSON HOUSE, 6 CHERRY ORCHARD ROAD, CROYDON, CRO 6BA, UNITED KINGDOM		
<b>DATE OF REGISTRATION</b>	22/01/2014	
<b>TITLE</b>	TEXTILE FABRIC	
<b>PRIORITY NA</b>		

<b>DESIGN NUMBER</b>	259668	
<b>CLASS</b>	15-05	
<b>1)LG ELECTRONICS INC.</b> 128 YEOUNI-DAERO, YEONGDEUNGPO - GU, SEOUL 150 - 721, REPUBLIC OF KOREA A CORPORATION INCORPORATED UNDER THE LAWS OF THE REPUBLIC OF KOREA		
<b>DATE OF REGISTRATION</b>	24/01/2014	
<b>TITLE</b>	WASHING MACHINE	
<b>PRIORITY NA</b>		

<b>DESIGN NUMBER</b>	257583	
<b>CLASS</b>	26-05	
<b>1)M/S SHREE SANT KRIPA INTELLECTUAL, HAVING OFFICE AT</b> 7, AKSHAY COMPLEX, OFF. DHOLE PATIL ROAD, PUNE-411001, MAHARASHTRA, INDIA, AN INDIAN COMPANY		
<b>DATE OF REGISTRATION</b>	21/10/2013	
<b>TITLE</b>	CEILING FIXTURES FOR LAMPS	
<b>PRIORITY NA</b>		

<b>DESIGN NUMBER</b>	257166	
<b>CLASS</b>	03-01	
<b>1)DOMINIK MAREK, OF ZA SOKOLOVNOU 601, 285 04 UHLIRSKE JANOVICE, CZECH REPUBLIC</b>		
<b>DATE OF REGISTRATION</b>	03/10/2013	
<b>TITLE</b>	SHOPPING BAG	
<b>PRIORITY NA</b>		

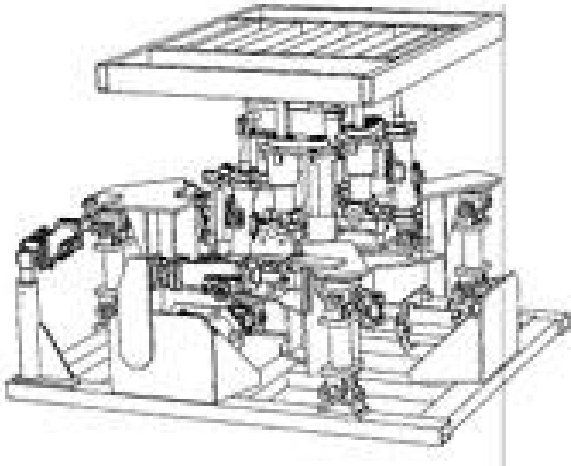
<b>DESIGN NUMBER</b>	257735	
<b>CLASS</b>	15-99	
<b>1)ZEN TECHNOLOGIES LIMITED, WHOSE ADDRESS IS B-42, INDUSTRIAL ESTATE, SANATHNAGAR, HYDERABAD- 500018, ANDHRA PRADESH AND WHOSE NATIONALITY IS INDIA</b>		
<b>DATE OF REGISTRATION</b>	25/10/2013	
<b>TITLE</b>	MOTION PLATFORM ASSEMBLY FOR DRIVING SIMULATORS	
<b>PRIORITY NA</b>		

<b>DESIGN NUMBER</b>	258296	
<b>CLASS</b>	06-04	
<b>1)ASSA ABLOY ASIA PACIFIC LIMITED OF 33/F LAWS COMMERCIAL PLAZA, 788 CHEUNG SHA WAN ROAD, KOWLOON, HONG KONG</b>		
<b>DATE OF REGISTRATION</b>	22/11/2013	
<b>TITLE</b>	SAFE	
<b>PRIORITY NA</b>		

<b>DESIGN NUMBER</b>	258384	
<b>CLASS</b>	02-03	
<b>1)M/S STEELBIRD HI-TECH INDIA LIMITED, A COMPANY INCORPORATED UNDER THE COMPANIES ACT, 1956, HAVING ITS REGISTERED OFFICE AT</b> B2B 17, NEAR METRO PILLAR 540, JANAK PURI, NEW DELHI-110058		
<b>DATE OF REGISTRATION</b>	26/11/2013	
<b>TITLE</b>	HELMET	
<b>PRIORITY NA</b>		

<b>DESIGN NUMBER</b>	259572	
<b>CLASS</b>	05-05	
<b>1)PARRY MURRAY &amp; CO. LTD., COMPANY REGISTERED UNDER THE LAWS OF ENGLAND AND WALES, HAVING ITS PRINCIPAL PLACE OF BUSINESS AT</b> 3RD FLOOR, SIMPSON HOUSE, 6 CHERRY ORCHARD ROAD, CROYDON, CRO 6BA, UNITED KINGDOM		
<b>DATE OF REGISTRATION</b>	22/01/2014	
<b>TITLE</b>	TEXTILE FABRIC	
<b>PRIORITY NA</b>		

<b>DESIGN NUMBER</b>	259664	
<b>CLASS</b>	08-09	
<b>1)CHANDAN JAIN, AN INDIAN NATIONAL, OF THE ADDRESS</b> 6A, SESSION MARG, NEAR SAMARPAN HOSPITAL, KARNAL-132001, HARYANA, INDIA		
<b>DATE OF REGISTRATION</b>	24/01/2014	
<b>TITLE</b>	DOOR CLOSER	
<b>PRIORITY NA</b>		

<b>DESIGN NUMBER</b>	259055	
<b>CLASS</b>	14-03	
<b>1)NOKIA CORPORATION, A FINNISH CORPORATION, OF THE ADDRESS KEILALAHDENTIE 4, ESPOO, FINLAND 02150</b>		
<b>DATE OF REGISTRATION</b>	27/12/2013	
<b>TITLE</b>	TABLET COMPUTER	
<b>PRIORITY</b>		
<b>PRIORITY NUMBER</b>	<b>DATE</b>	<b>COUNTRY</b>
29/464957	22/08/2013	U.S.A.

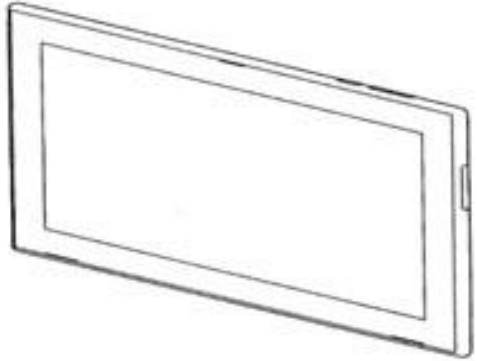

<b>DESIGN NUMBER</b>	257579	
<b>CLASS</b>	26-05	
<b>1)M/S SHREE SANT KRIPA INTELLECTUAL, HAVING OFFICE AT 7, AKSHAY COMPLEX, OFF. DHOLE PATIL ROAD, PUNE-411001, MAHARASHTRA, INDIA, AN INDIAN COMPANY</b>		
<b>DATE OF REGISTRATION</b>	21/10/2013	
<b>TITLE</b>	CEILING FIXTURES FOR LAMPS	
<b>PRIORITY NA</b>		





<b>DESIGN NUMBER</b>	257744	
<b>CLASS</b>	12-08	
<b>1)DR. ING. H.C.F. PORSCHE AKTIENGESELLSCHAFT, A GERMAN COMPANY OF PORSCHEPLATZ 1, 70435 STUTTGART, GERMANY</b>		
<b>DATE OF REGISTRATION</b>	25/10/2013	
<b>TITLE</b>	CAR	
<b>PRIORITY NA</b>		



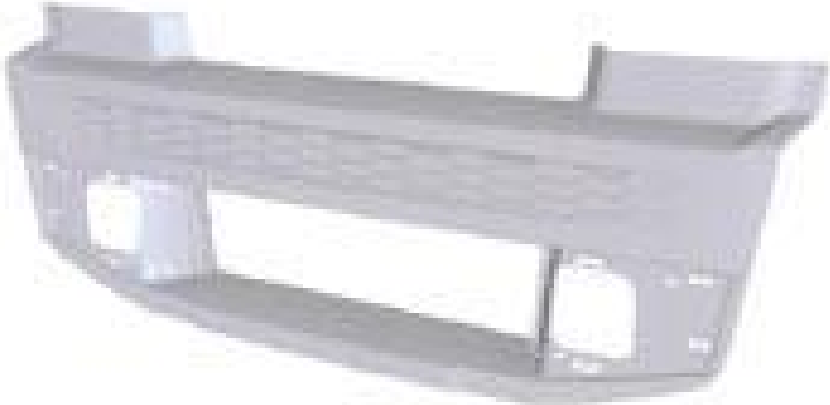

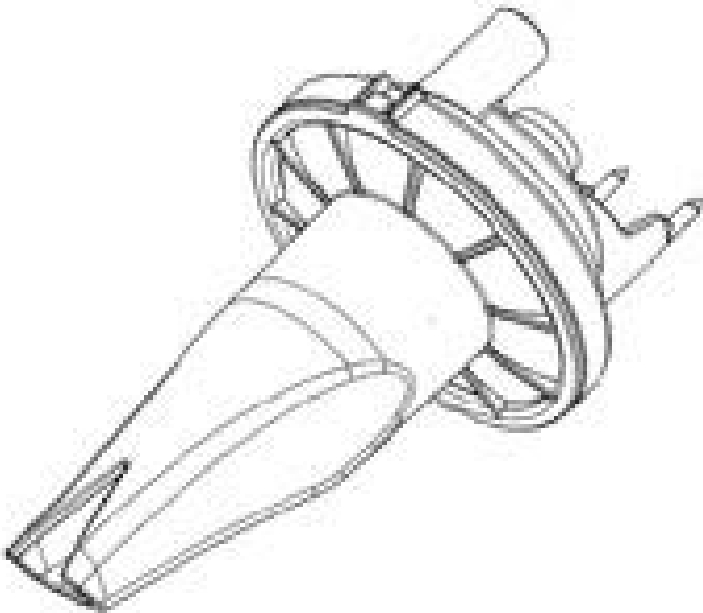
<b>DESIGN NUMBER</b>	257249		
<b>CLASS</b>	12-16		
<b>1)VOLVO LASTVAGNAR AB, OF 405 08 GÖTEBORG, SWEDEN</b>			
<b>DATE OF REGISTRATION</b>	08/10/2013		
<b>TITLE</b>	FRONT PANEL FOR VEHICLE		
<b>PRIORITY</b>			
<b>PRIORITY NUMBER</b>	<b>DATE</b>	<b>COUNTRY</b>	
002219360-0005	12/04/2013	OHIM	

<b>DESIGN NUMBER</b>	257870		
<b>CLASS</b>	15-99		
<b>1)SULZER MIXPAC AG, OF RÜTISTRASSE 7, 9469 HAAG, SWITZERLAND</b>			
<b>DATE OF REGISTRATION</b>	30/10/2013		
<b>TITLE</b>	INDUSTRIAL MIXER		
<b>PRIORITY</b>			
<b>PRIORITY NUMBER</b>	<b>DATE</b>	<b>COUNTRY</b>	
139967	29/05/2013	SWITZERLAND	

<b>DESIGN NUMBER</b>	259194		
<b>CLASS</b>	07-01		
<b>1)RAVISSANT PRIVATE LIMITED, AN INDIAN COMPANY, OF THE ADDRESS 50-51, COMMERCIAL COMPLEX, NEW FRIENDS COLONY, NEW DELHI-110065, INDIA</b>			
<b>DATE OF REGISTRATION</b>	03/01/2014		
<b>TITLE</b>	BOWL		
<b>PRIORITY NA</b>			

<b>DESIGN NUMBER</b>	259552	
<b>CLASS</b>	13-03	
<b>1)YAZAKI CORPORATION, A JAPANESE CORPORATION OF</b> 4-28, MITA 1-CHOME, MINATO-KU, TOKYO 108-8333 JAPAN		
<b>DATE OF REGISTRATION</b>	21/01/2014	
<b>TITLE</b>	HOUSING FOR ELECTRIC CONNECTOR	
<b>PRIORITY</b>		
<b>PRIORITY NUMBER</b>	<b>DATE</b>	<b>COUNTRY</b>
2013-016591	22/07/2013	JAPAN

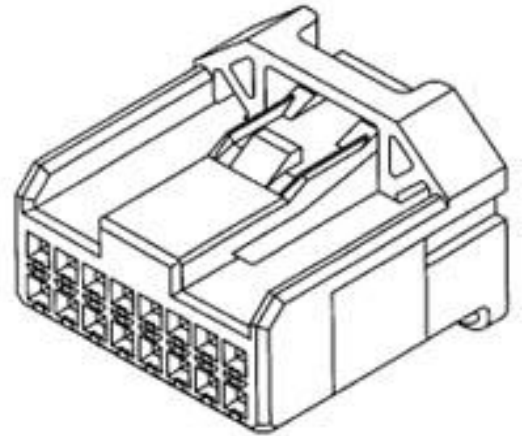



<b>DESIGN NUMBER</b>	259135	
<b>CLASS</b>	13-03	
<b>1)ABB INDIA LIMITED, HAVING REGISTERED OFFICE</b> AT 2ND FLOOR, EAST WING, KHANIJA BHAVAN, 49, RACE COURSE ROAD, BANGALORE 560001, KARNATAKA, INDIA, AN INDIAN COMPANY		
<b>DATE OF REGISTRATION</b>	30/12/2013	
<b>TITLE</b>	CEILING ROSE COVER	
<b>PRIORITY NA</b>		



<b>DESIGN NUMBER</b>	257258	
<b>CLASS</b>	12-16	
<b>1)VOLVO LASTVAGNAR AB, OF</b> 405 08 GÖTEBORG, SWEDEN		
<b>DATE OF REGISTRATION</b>	08/10/2013	
<b>TITLE</b>	FRONT PANEL FOR VEHICLE	
<b>PRIORITY</b>		
<b>PRIORITY NUMBER</b>	<b>DATE</b>	<b>COUNTRY</b>
002219568-0001	12/04/2013	OHIM

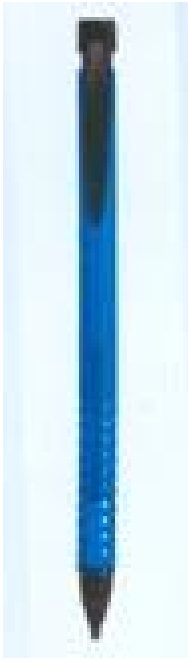

<b>DESIGN NUMBER</b>	257246	
<b>CLASS</b>	12-16	
<b>1)VOLVO LASTVAGNAR AB, OF 405 08 GÖTEBORG, SWEDEN</b>		
<b>DATE OF REGISTRATION</b>	08/10/2013	
<b>TITLE</b>	FRONT PANEL FOR VEHICLE	
<b>PRIORITY</b>		
<b>PRIORITY NUMBER</b>	<b>DATE</b>	<b>COUNTRY</b>
002219360-0002	12/04/2013	OHIM
<b>DESIGN NUMBER</b>	259183	
<b>CLASS</b>	19-06	
<b>1)ADD CORPORATION LIMITED OF BUSINESS PARK, 6TH FLOOR, CHINCHOLI NAKA, S. V. ROAD, MALAD (WEST), MUMBAI-400064, MAHARASHTRA, INDIA, INDIAN COMPANY</b>		
<b>DATE OF REGISTRATION</b>	02/01/2014	
<b>TITLE</b>	PENCIL	
<b>PRIORITY NA</b>		
<b>DESIGN NUMBER</b>	259776	
<b>CLASS</b>	09-01	
<b>1)VFF (INDIA) LIMITED AN INDIAN COMPANY INCORPORATED UNDER THE PROVISIONS OF THE COMPANIES ACT, HAVING OFFICE OPP. SION FORT GARDEN, 109, SION (EAST), MUMBAI-400022, MAHARASHTRA, INDIA</b>		
<b>DATE OF REGISTRATION</b>	29/01/2014	
<b>TITLE</b>	BOTTLE	
<b>PRIORITY NA</b>		

<b>DESIGN NUMBER</b>	257381	
<b>CLASS</b>	10-07	
<b>1)SWATCH AG (SWATCH SA) (SWATCH LTD), A SWISS COMPANY OF</b> JAKOB-STAMPFLI-STRASSE 94, CH-2502 BIEL/BIENNE, SWITZERLAND		
<b>DATE OF REGISTRATION</b>	10/10/2013	
<b>TITLE</b>	WATCH MOVEMENT	
<b>PRIORITY</b>		
<b>PRIORITY NUMBER</b>	<b>DATE</b>	<b>COUNTRY</b>
DM 080 666	16/04/2013	WIPO

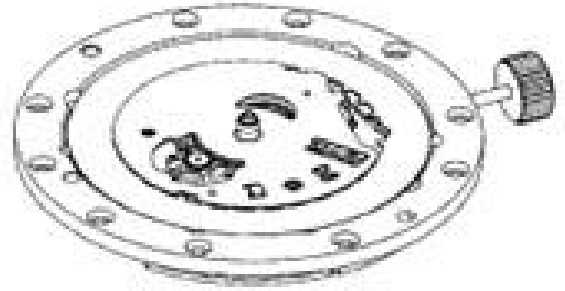





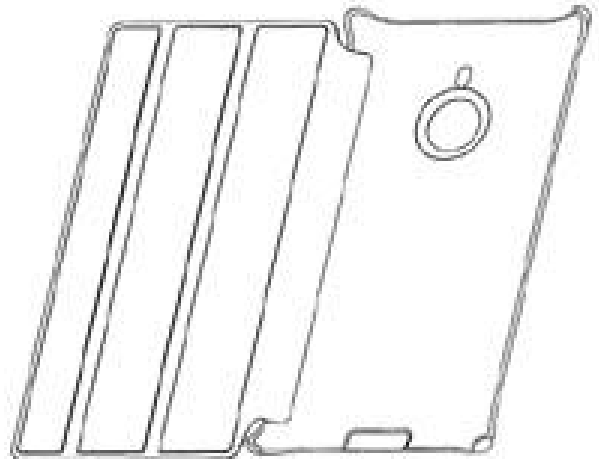

<b>DESIGN NUMBER</b>	258892	
<b>CLASS</b>	12-16	
<b>1)HONDA MOTOR CO., LTD., A JAPANESE CORPORATION, OF</b> 1-1, MINAMI-AOYAMA 2-CHOME, MINATO-KU, TOKYO, 107-8556, JAPAN		
<b>DATE OF REGISTRATION</b>	20/12/2013	
<b>TITLE</b>	INSTRUMENT PANEL FOR AUTOMOBILE	
<b>PRIORITY</b>		
<b>PRIORITY NUMBER</b>	<b>DATE</b>	<b>COUNTRY</b>
2013-014755	28/06/2013	JAPAN

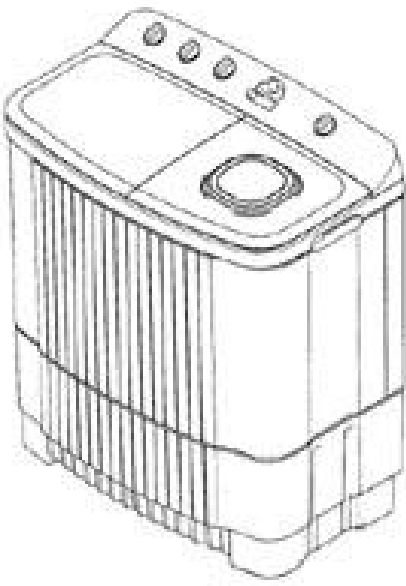

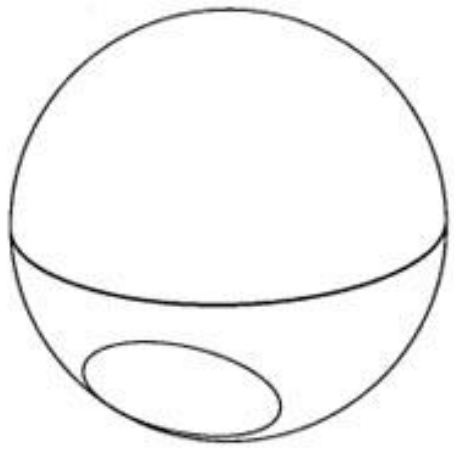
<b>DESIGN NUMBER</b>	259057	
<b>CLASS</b>	14-03	
<b>1)NOKIA CORPORATION, A FINNISH CORPORATION</b> OF THE ADDRESS KEILALAHDENTIE 4, ESPOO, FINLAND 02150		
<b>DATE OF REGISTRATION</b>	27/12/2013	
<b>TITLE</b>	MOBILE PHONE COVER	
<b>PRIORITY</b>		
<b>PRIORITY NUMBER</b>	<b>DATE</b>	<b>COUNTRY</b>
29/465240	26/08/2013	U.S.A.



<b>DESIGN NUMBER</b>	259666	
<b>CLASS</b>	15-05	
<b>1) LG ELECTRONICS INC.</b> 128 YEOUNI-DAERO, YEONGDEUNGPO - GU, SEOUL 150 - 721, REPUBLIC OF KOREA A CORPORATION INCORPORATED UNDER THE LAWS OF THE REPUBLIC OF KOREA		
<b>DATE OF REGISTRATION</b>	24/01/2014	
<b>TITLE</b>	WASHING MACHINE	
<b>PRIORITY NA</b>		
<b>DESIGN NUMBER</b>	257581	
<b>CLASS</b>	26-05	
<b>1) M/S SHREE SANT KRIPA INTELLECTUAL, HAVING OFFICE AT</b> 7, AKSHAY COMPLEX, OFF. DHOLE PATIL ROAD, PUNE-411001, MAHARASHTRA, INDIA, AN INDIAN COMPANY		
<b>DATE OF REGISTRATION</b>	21/10/2013	
<b>TITLE</b>	CEILING FIXTURES FOR LAMPS	
<b>PRIORITY NA</b>		
<b>DESIGN NUMBER</b>	257300	
<b>CLASS</b>	09-03	
<b>1) INTERNATIONAL COSMETIC SUPPLIERS LTD., A CORPORATION ORGANIZED AND EXISTING UNDER THE LAW OF TAIWAN, OF</b> 4F, #96, SECTION 1 CHIEN KUO NORTH ROAD, TAIPEI 10489, TAIWAN		
<b>DATE OF REGISTRATION</b>	08/10/2013	
<b>TITLE</b>	CONTAINER	
<b>PRIORITY NA</b>		

<b>DESIGN NUMBER</b>	257488		
<b>CLASS</b>	07-01		
<b>1)K. B. PRODUCTS PVT. LTD., (AN INDIAN PRIVATE LIMITED COMPANY REGISTERED UNDER THE INDIAN COMPANIES ACT 1956), OF</b> 946, DADIBA COMPOUND, VAL-VILLAGE, ANJUR FATA, TAL. BHIWANDI, DIST-THANE, MAHARASHTRA, PIN-421 302, MAHARASHTRA, INDIA			
<b>DATE OF REGISTRATION</b>	14/10/2013		
<b>TITLE</b>	JAR		
<b>PRIORITY NA</b>			
<b>DESIGN NUMBER</b>	257243		
<b>CLASS</b>	21-01		
<b>1)VOLVO LASTVAGNAR AB, OF</b> 405 08 GÖTEBORG, SWEDEN			
<b>DATE OF REGISTRATION</b>	08/10/2013		
<b>TITLE</b>	TOY TRUCK		
<b>PRIORITY</b>			
<b>PRIORITY NUMBER</b>	<b>DATE</b>	<b>COUNTRY</b>	
002219204-0001	12/04/2013	OHIM	
<b>DESIGN NUMBER</b>	258045		
<b>CLASS</b>	08-08		
<b>1)MUNAWER JAMAL, INDIAN NATIONAL,</b> 7 KM STONE, PREM NAGAR EXPORT ZONE, KANTH ROAD, MORADABAD-244 001, UTTAR PRADESH, INDIA.			
<b>DATE OF REGISTRATION</b>	08/11/2013		
<b>TITLE</b>	WALL HANGER		
<b>PRIORITY NA</b>			

<b>DESIGN NUMBER</b>	258150	
<b>CLASS</b>	26-05	
<b>1)3M INNOVATIVE PROPERTIES COMPANY, A COMPANY INCORPORATED IN THE STATE OF DELAWARE</b> OF 3M CENTER, SAINT PAUL, MINNESOTA 55133-3427, U.S.A.		
<b>DATE OF REGISTRATION</b>	14/11/2013	
<b>TITLE</b>	LIGHTGUIDE LIGHTING ASSEMBLY	
<b>PRIORITY</b>		
<b>PRIORITY NUMBER</b>	<b>DATE</b>	<b>COUNTRY</b>
29/454,868	15/05/2013	U.S.A.

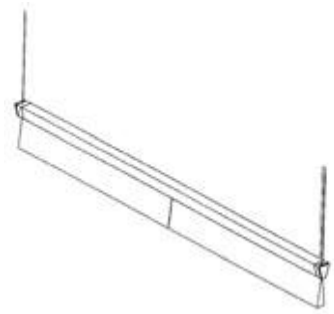

<b>DESIGN NUMBER</b>	259179	
<b>CLASS</b>	28-03	
<b>1)KONINKLIJKE PHILIPS N.V., A COMPANY ORGANIZED AND EXISTING UNDER THE LAWS OF THE KINGDOM OF THE NETHERLANDS, RESIDING AT EINDHOVEN, WHOSE POST-OFFICE ADDRESS IS</b> HIGH TECH CAMPUS 5, 5656 AE EINDHOVEN, THE NETHERLANDS		
<b>DATE OF REGISTRATION</b>	02/01/2014	
<b>TITLE</b>	EPILATOR	
<b>PRIORITY</b>		
<b>PRIORITY NUMBER</b>	<b>DATE</b>	<b>COUNTRY</b>
002280313-0005	24/07/2013	OHIM



<b>DESIGN NUMBER</b>	256601
<b>CLASS</b>	08-06
<b>1)HARESHBHAI SAVJIBHA FACHARA (INDIAN NATIONAL) AND SOLE PROPRIETOR OF M/S. J. B. ENTERPRISE HAVING PLACE OF BUSINESS AT,</b> PLOT NO. 01, SURVEY NO. 31, NR. RAJ FIBER, VAVDI, GONDAL ROAD, RAJKOT. (GUJARAT)	
<b>DATE OF REGISTRATION</b>	19/09/2013
<b>TITLE</b>	HANDLE
<b>PRIORITY NA</b>	

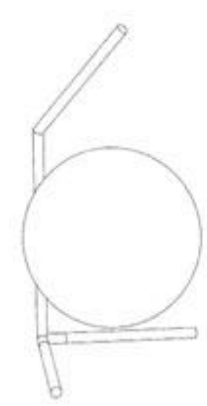
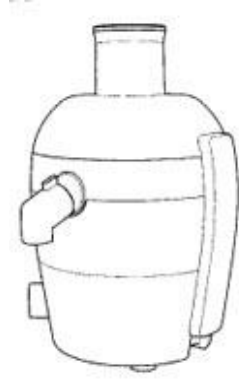

<b>DESIGN NUMBER</b>	259671							
<b>CLASS</b>	23-01							
<b>1) LG ELECTRONICS INC.</b> 128 YEOUI-DAERO, YEONGDEUNGPO - GU, SEOUL 150 - 721, REPUBLIC OF KOREA A CORPORATION INCORPORATED UNDER THE LAWS OF THE REPUBLIC OF KOREA								
<b>DATE OF REGISTRATION</b>	24/01/2014							
<b>TITLE</b>	WATER PURIFIER							
<b>PRIORITY NA</b>								
<b>DESIGN NUMBER</b>	256833							
<b>CLASS</b>	26-05							
<b>1) FLOS S.P.A., AN ITALIAN COMPANY,</b> VIA A. FAINI, 2, I-25073 BOVEZZO, BRESCIA, ITALY.								
<b>DATE OF REGISTRATION</b>	26/09/2013							
<b>TITLE</b>	TABLE LAMP							
<b>PRIORITY</b>								
<table border="1"> <thead> <tr> <th>PRIORITY NUMBER</th> <th>DATE</th> <th>COUNTRY</th> </tr> </thead> <tbody> <tr> <td>BS2013O000012</td> <td>29/03/2013</td> <td>ITALY</td> </tr> </tbody> </table>			PRIORITY NUMBER	DATE	COUNTRY	BS2013O000012	29/03/2013	ITALY
PRIORITY NUMBER	DATE	COUNTRY						
BS2013O000012	29/03/2013	ITALY						
<b>DESIGN NUMBER</b>	257766							
<b>CLASS</b>	31-00							
<b>1) KONINKLIJKE PHILIPS N.V., A COMPANY ORGANIZED AND EXISTING UNDER THE LAWS OF THE KINGDOM OF THE NETHERLANDS, RESIDING AT EINDHOVEN,</b> WHOSE POST-OFFICE ADDRESS IS HIGH TECH CAMPUS 5, 5656 AE EINDHOVEN, THE NETHERLANDS								
<b>DATE OF REGISTRATION</b>	25/10/2013							
<b>TITLE</b>	JUICER							
<b>PRIORITY</b>								
<table border="1"> <thead> <tr> <th>PRIORITY NUMBER</th> <th>DATE</th> <th>COUNTRY</th> </tr> </thead> <tbody> <tr> <td>002233429-0001</td> <td>07/05/2013</td> <td>OHIM</td> </tr> </tbody> </table>			PRIORITY NUMBER	DATE	COUNTRY	002233429-0001	07/05/2013	OHIM
PRIORITY NUMBER	DATE	COUNTRY						
002233429-0001	07/05/2013	OHIM						



<b>DESIGN NUMBER</b>	257250	
<b>CLASS</b>	12-16	
1)VOLVO LASTVAGNAR AB, OF 405 08 GÖTEBORG, SWEDEN		
<b>DATE OF REGISTRATION</b>	08/10/2013	
<b>TITLE</b>	GRILLE FOR VEHICLE	
<b>PRIORITY</b>		
<b>PRIORITY NUMBER</b>	<b>DATE</b>	<b>COUNTRY</b>
002219360-0006	12/04/2013	OHIM

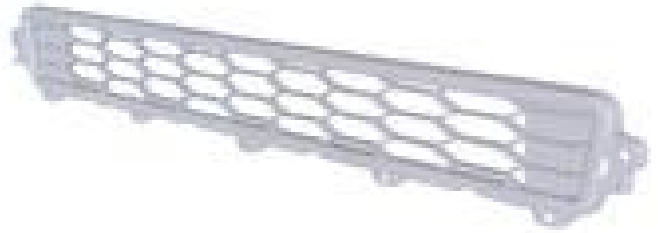

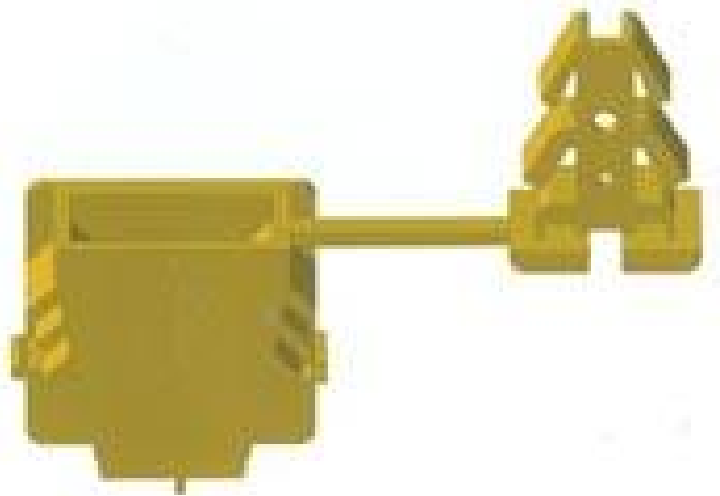

<b>DESIGN NUMBER</b>	254416	
<b>CLASS</b>	08-07	
1)PRAVIN LUNIA, P/O DELTA SEALS & ELECTRICALS, 445, SADHU VASVANI NAGAR, INDORE-452 001, (M.P.)		
<b>DATE OF REGISTRATION</b>	11/06/2013	
<b>TITLE</b>	SECURITY SEAL	
<b>PRIORITY NA</b>		



<b>DESIGN NUMBER</b>	259285	
<b>CLASS</b>	23-01	
1)HANSGROHE SE, OF AUESTR. 5-9, D-77761 SCHILTACH, GERMANY, A GERMAN COMPANY		
<b>DATE OF REGISTRATION</b>	07/01/2014	
<b>TITLE</b>	GRIP FOR A FAUCET	
<b>PRIORITY</b>		
<b>PRIORITY NUMBER</b>	<b>DATE</b>	<b>COUNTRY</b>
001379184-0005	29/07/2013	OHIM

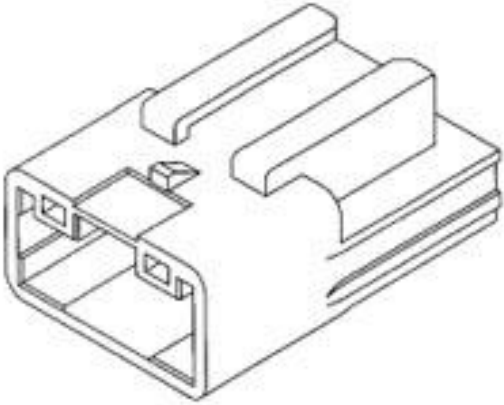

<b>DESIGN NUMBER</b>	259553	
----------------------	--------	--

<b>CLASS</b>	13-03		
<b>1)YAZAKI CORPORATION, A JAPANESE CORPORATION OF</b> 4-28, MITA 1-CHOME, MINATO-KU, TOKYO 108-8333 JAPAN			
<b>DATE OF REGISTRATION</b>	21/01/2014		
<b>TITLE</b>	HOUSING FOR ELECTRIC CONNECTOR		
<b>PRIORITY</b>			
<b>PRIORITY NUMBER</b>	<b>DATE</b>	<b>COUNTRY</b>	
2013-016592	22/07/2013	JAPAN	
<b>DESIGN NUMBER</b>	259099		
<b>CLASS</b>	19-06		
<b>1)K-NINE WRITING SYSTEMS PVT. LTD. (AN INDIAN NATIONAL) UNIT NO:</b> <b>A-301/302, SUNFLOWER BUILDING, PLOT NO-36 A, SHIVNERI MARG,</b> OFF GOREGAON-MULUND LINK ROAD, AMBEDKAR CHOWK, GOREGAON- EAST, MUMBAI-400063, STATE OF MAHARASHTRA, INDIA.			
<b>DATE OF REGISTRATION</b>	27/12/2013		
<b>TITLE</b>	PEN		
<b>PRIORITY NA</b>			
<b>DESIGN NUMBER</b>	257259		
<b>CLASS</b>	12-16		
<b>1)VOLVO LASTVAGNAR AB, OF</b> 405 08 GÖTEBORG, SWEDEN			
<b>DATE OF REGISTRATION</b>	08/10/2013		
<b>TITLE</b>	FRONT PANEL FOR VEHICLE		
<b>PRIORITY</b>			
<b>PRIORITY NUMBER</b>	<b>DATE</b>	<b>COUNTRY</b>	
002219568-0002	12/04/2013	OHIM	

<b>DESIGN NUMBER</b>	257242	
<b>CLASS</b>	12-08	
1)VOLVO LASTVAGNAR AB, OF 405 08 GÖTEBORG, SWEDEN		
<b>DATE OF REGISTRATION</b>	08/10/2013	
<b>TITLE</b>	VEHICLE CAB	
<b>PRIORITY</b>		
<b>PRIORITY NUMBER</b>	<b>DATE</b>	<b>COUNTRY</b>
002219204-0001	12/04/2013	OHIM



<b>DESIGN NUMBER</b>	257829	
<b>CLASS</b>	24-02	
1)KONINKLIJKE PHILIPS N.V., A COMPANY ORGANIZED AND EXISTING UNDER THE LAWS OF THE KINGDOM OF THE NETHERLANDS, RESIDING AT EINDHOVEN, WHOSE POST-OFFICE ADDRESS IS HIGH TECH CAMPUS 5, 5656 AE EINDHOVEN, THE NETHERLANDS		
<b>DATE OF REGISTRATION</b>	29/10/2013	
<b>TITLE</b>	FRAME FOR A PATIENT INTERFACE ASSEMBLY FOR RESPIRATORY THERAPY	
<b>PRIORITY</b>		
<b>PRIORITY NUMBER</b>	<b>DATE</b>	<b>COUNTRY</b>
002233619-0003	07/05/2013	OHIM

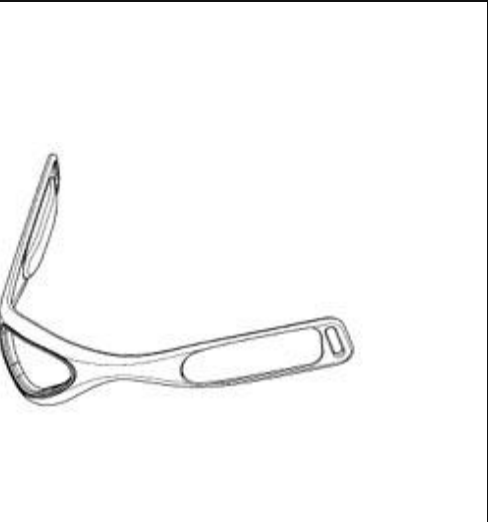

<b>DESIGN NUMBER</b>	258035	
<b>CLASS</b>	17-01	
1)SYDNEY MATHEWS, A CANADIAN NATIONAL OF THE ADDRESS 200 RIDEAU TERRACE, APT 1403 OTTAWA, ONTARIO K1M 0Z3, CANADA		
<b>DATE OF REGISTRATION</b>	07/11/2013	
<b>TITLE</b>	KEYBOARD KEY	
<b>PRIORITY</b>		
<b>PRIORITY NUMBER</b>	<b>DATE</b>	<b>COUNTRY</b>
152476	20/08/2013	CANADA

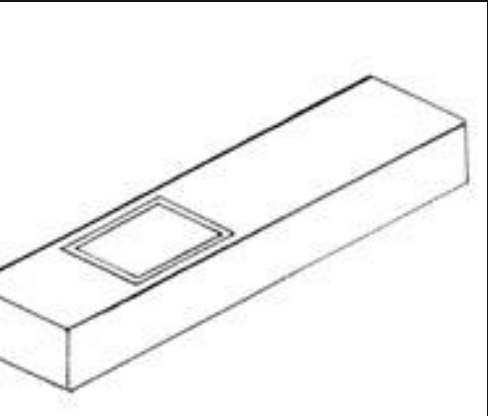



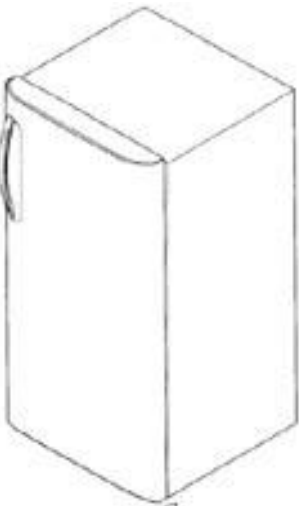

<b>DESIGN NUMBER</b>	251498		
<b>CLASS</b>	12-05		
<b>1)KITO CORPORATION,</b> 2000, TSUIJIARAI, SHOWA-CHO, NAKAKOMA-GUN, YAMANASHI, 409-3853, JAPAN; A JAPANESE CORPORATION			
<b>DATE OF REGISTRATION</b>	07/02/2013		
<b>TITLE</b>	CHAIN HOIST		
<b>PRIORITY</b>			
<b>PRIORITY NUMBER</b>	<b>DATE</b>	<b>COUNTRY</b>	
2012-019241	09/08/2012	JAPAN	
<b>DESIGN NUMBER</b>			
<b>DESIGN NUMBER</b>	259178		
<b>CLASS</b>	28-03		
<b>1)KONINKLIJKE PHILIPS N.V., A COMPANY ORGANIZED AND EXISTING</b> <b>UNDER THE LAWS OF THE KINGDOM OF THE NETHERLANDS, RESIDING AT</b> <b>EINDHOVEN, WHOSE POST-OFFICE ADDRESS IS</b> HIGH TECH CAMPUS 5, 5656 AE EINDHOVEN, THE NETHERLANDS			
<b>DATE OF REGISTRATION</b>	02/01/2014		
<b>TITLE</b>	HAIR REMOVAL DEVICE		
<b>PRIORITY</b>			
<b>PRIORITY NUMBER</b>	<b>DATE</b>	<b>COUNTRY</b>	
002280313-0003	24/07/2013	OHIM	
<b>DESIGN NUMBER</b>			
<b>DESIGN NUMBER</b>	259251		
<b>CLASS</b>	09-07		
<b>1)SH. MANISH GOYAL,</b> 133, KAPIL VIHAR, PITAMPURA, DELHI-110034, (INDIA). AN INDIAN NATIONAL OF THE ABOVE ADDRESS			
<b>DATE OF REGISTRATION</b>	06/01/2014		
<b>TITLE</b>	BOTTLE CAP		
<b>PRIORITY NA</b>			

<b>DESIGN NUMBER</b>	259670	
<b>CLASS</b>	15-07	
<b>1) LG ELECTRONICS INC.</b> 128 YEOUNI-DAERO, YEONGDEUNGPO - GU, SEOUL 150 - 721, REPUBLIC OF KOREA A CORPORATION INCORPORATED UNDER THE LAWS OF THE REPUBLIC OF KOREA		
<b>DATE OF REGISTRATION</b>	24/01/2014	
<b>TITLE</b>	REFRIGERATOR	
<b>PRIORITY NA</b>		

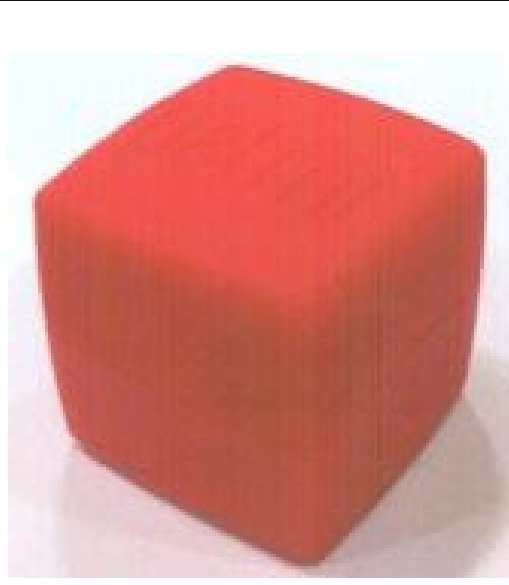
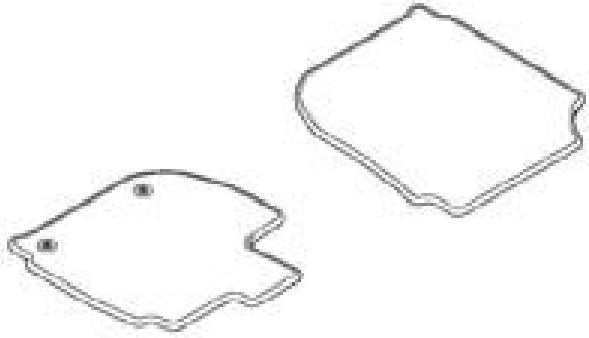
<b>DESIGN NUMBER</b>	259813	
<b>CLASS</b>	12-11	
<b>1) BAJAJ AUTO LIMITED, AN INDIAN COMPANY, INCORPORATED UNDER THE COMPANIES ACT OF 1956, HAVING ITS PRINCIPAL PLACE OF BUSINESS AT NEW 2ND &amp; 3RD FLOOR, KHIVRAJ BUILDING, NO. 616, ANNASALAI, CHENNAI - 600006, STATE OF TAMIL NADU, INDIA, AND REGISTERED OFFICE AT AKURDI, PUNE-411035, STATE OF MAHARASHTRA, INDIA</b>		
<b>DATE OF REGISTRATION</b>	29/01/2014	
<b>TITLE</b>	FRONT FENDER FOR MOTORCYCLE	
<b>PRIORITY NA</b>		

<b>DESIGN NUMBER</b>	257765		
<b>CLASS</b>	07-05		
<b>1) KONINKLIJKE PHILIPS N.V., A COMPANY ORGANIZED AND EXISTING UNDER THE LAWS OF THE KINGDOM OF THE NETHERLANDS, RESIDING AT EINDHOVEN, WHOSE POST-OFFICE ADDRESS IS HIGH TECH CAMPUS 5, 5656 AE EINDHOVEN, THE NETHERLANDS</b>			
<b>DATE OF REGISTRATION</b>	25/10/2013		
<b>TITLE</b>	IRON WITH STEAM GENERATOR		
<b>PRIORITY</b>			
<b>PRIORITY NUMBER</b>	<b>DATE</b>	<b>COUNTRY</b>	
002231514-0003	02/05/2013	OHIM	

<b>DESIGN NUMBER</b>	258822		
<b>CLASS</b>	09-03		
<b>1)ZAMYA LIMITED,</b> 319 ORDSALL LANE, MANCHESTER, SALFORD, M5, 3FT, UNITED KINGDOM, A PRIVATE LIMITED COMPANY ORGANIZED AND EXISTING UNDER			
<b>DATE OF REGISTRATION</b>	18/12/2013		
<b>TITLE</b>	CONTAINER FOR COSMETICS		
<b>PRIORITY NA</b>			
<b>DESIGN NUMBER</b>	259102		
<b>CLASS</b>	06-11		
<b>1)HONDA ACCESS CORP.,</b> OF 18-4, 8-CHOME, NOBIDOME, NIIZA-SHI, SAITAMA, JAPAN			
<b>DATE OF REGISTRATION</b>	30/12/2013		
<b>TITLE</b>	A SET OF FLOOR MATS FOR VEHICLE		
<b>PRIORITY</b>			
<b>PRIORITY NUMBER</b>	<b>DATE</b>	<b>COUNTRY</b>	
2013-016441	19/07/2013	JAPAN	
<b>DESIGN NUMBER</b>	257411		
<b>CLASS</b>	12-16		
<b>1)VOLVO LASTVAGNAR AB, OF</b> SE 405 08 GÖTEBORG, SWEDEN.			
<b>DATE OF REGISTRATION</b>	10/10/2013		
<b>TITLE</b>	ROOF AIR DEFLECTOR FOR VEHICLES		
<b>PRIORITY</b>			
<b>PRIORITY NUMBER</b>	<b>DATE</b>	<b>COUNTRY</b>	
2013/0162	11/04/2013	SWEDEN	

<b>DESIGN NUMBER</b>	260133		
<b>CLASS</b>	08-07		
<b>1)SURESH MARUTI MORE. (AN INDIAN NATIONAL) 102/1ST FLOOR  UTKARSH CO.OP.HSG.LTD. ANANDROA PAWAR HIGH SCHOOL, RAM  MANDIR ROAD, VAZIRA NAKA, BORIVALI (WEST), MUMBAI-400092, STATE  OF MAHARASHTRA, INDIA.</b> PROPRIETOR OF PACK SEALS INDUSTRIES. AN INDIAN PROPRIETORSHIP FIRM OF ABOVE ADDRESS			
<b>DATE OF REGISTRATION</b>	05/02/2014		
<b>TITLE</b>	SEAL		
<b>PRIORITY NA</b>			
<b>DESIGN NUMBER</b>	258498		
<b>CLASS</b>	26-04		
<b>1)KONINKLIJKE PHILIPS N.V., A COMPANY ORGANIZED AND EXISTING  UNDER THE LAWS OF THE KINGDOM OF THE NETHERLANDS, RESIDING AT  EINDHOVEN,</b> WHOSE POST-OFFICE ADDRESS IS HIGH TECH CAMPUS 5, 5656 AE EINDHOVEN, THE NETHERLANDS			
<b>DATE OF REGISTRATION</b>	29/11/2013		
<b>TITLE</b>	LED BULB		
<b>PRIORITY</b>			
<b>PRIORITY NUMBER</b>	<b>DATE</b>	<b>COUNTRY</b>	
002282392-0003	26/07/2013	OHIM	
<b>DESIGN NUMBER</b>	256484		
<b>CLASS</b>	11-02		
<b>1)MA DESIGN INDIA PRIVATE LIMITED, A COMPANY  INCORPORATED IN INDIA HAVING ITS PRINCIPAL PLACE OF  BUSINESS AT</b> A-41, SECTOR-80, PHASE-II, NOIDA-201305, U.P. INDIA			
<b>DATE OF REGISTRATION</b>	16/09/2013		
<b>TITLE</b>	DECORATIVE ARTICLE		
<b>PRIORITY NA</b>			

<b>DESIGN NUMBER</b>	257416		
<b>CLASS</b>	12-16		
<b>1)VOLVO LASTVAGNAR AB, OF SE 405 08 GÖTEBORG, SWEDEN.</b>			
<b>DATE OF REGISTRATION</b>	10/10/2013		
<b>TITLE</b>	FENDER FOR VEHICLE		
<b>PRIORITY</b>			
<b>PRIORITY NUMBER</b>	<b>DATE</b>	<b>COUNTRY</b>	
2013/0171	11/04/2013	SWEDEN	
<b>DESIGN NUMBER</b>	257229		
<b>CLASS</b>	15-03		
<b>1)RAVANDS CONTROLS INCORPORATION, AN INDIAN COMPANY OF MALAIAH PALLI ROAD, CHANDRAGIRI-517101, TIRUPATI, ANDRHA PRADESH, INDIA</b>			
<b>DATE OF REGISTRATION</b>	07/10/2013		
<b>TITLE</b>	VENTURI INJECTOR BARREL		
<b>PRIORITY NA</b>			
<b>DESIGN NUMBER</b>	259575		
<b>CLASS</b>	05-05		
<b>1)PARRY MURRAY &amp; CO. LTD., COMPANY REGISTERED UNDER THE LAWS OF ENGLAND AND WALES, HAVING ITS PRINCIPAL PLACE OF BUSINESS AT 3RD FLOOR, SIMPSON HOUSE, 6 CHERRY ORCHARD ROAD, CROYDON, CRO 6BA, UNITED KINGDOM</b>			
<b>DATE OF REGISTRATION</b>	22/01/2014		
<b>TITLE</b>	TEXTILE FABRIC		
<b>PRIORITY NA</b>			

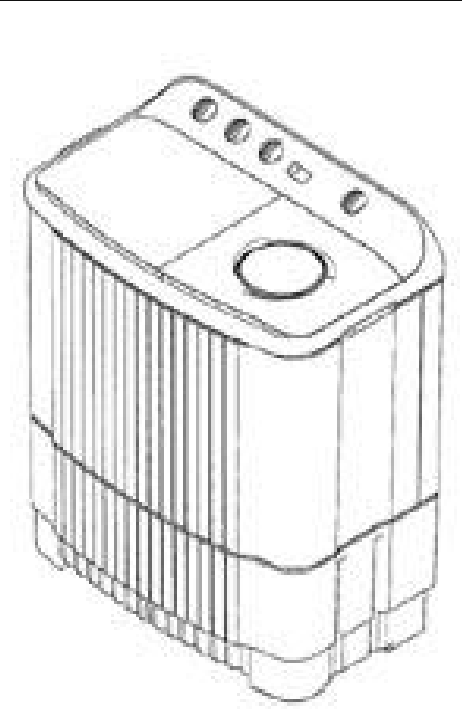

<b>DESIGN NUMBER</b>	259667	
<b>CLASS</b>	15-05	
<b>1) LG ELECTRONICS INC.</b> 128 YEOUNI-DAERO, YEONGDEUNGPO - GU, SEOUL 150 - 721, REPUBLIC OF KOREA A CORPORATION INCORPORATED UNDER THE LAWS OF THE REPUBLIC OF KOREA		
<b>DATE OF REGISTRATION</b>	24/01/2014	
<b>TITLE</b>	WASHING MACHINE	
<b>PRIORITY NA</b>		

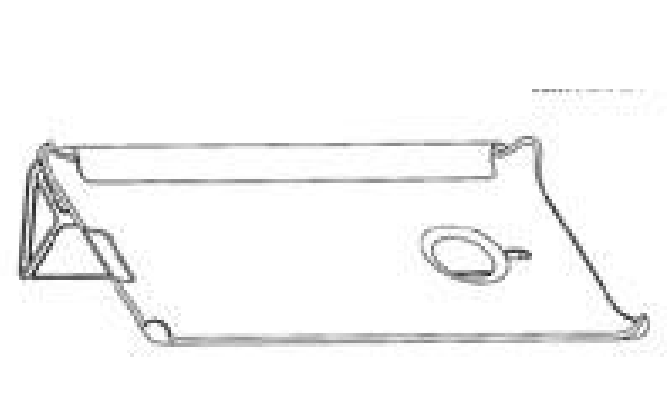
<b>DESIGN NUMBER</b>	259058		
<b>CLASS</b>	14-03		
<b>1) NOKIA CORPORATION</b> A FINNISH CORPORATION OF THE ADDRESS KEILALAHDENTIE 4, ESPOO, FINLAND 02150			
<b>DATE OF REGISTRATION</b>	27/12/2013		
<b>TITLE</b>	MOBILE PHONE COVER		
<b>PRIORITY</b>			
<b>PRIORITY NUMBER</b>	<b>DATE</b>	<b>COUNTRY</b>	
29/465240	26/08/2013	U.S.A.	

<b>DESIGN NUMBER</b>	257582		
<b>CLASS</b>	26-05		
<b>1) M/S SHREE SANT KRIPA INTELLECTUAL, HAVING OFFICE AT</b> 7, AKSHAY COMPLEX, OFF. DHOLE PATIL ROAD, PUNE-411001, MAHARASHTRA, INDIA, AN INDIAN COMPANY			
<b>DATE OF REGISTRATION</b>	21/10/2013		
<b>TITLE</b>	CEILING FIXTURES FOR LAMPS		
<b>PRIORITY NA</b>			

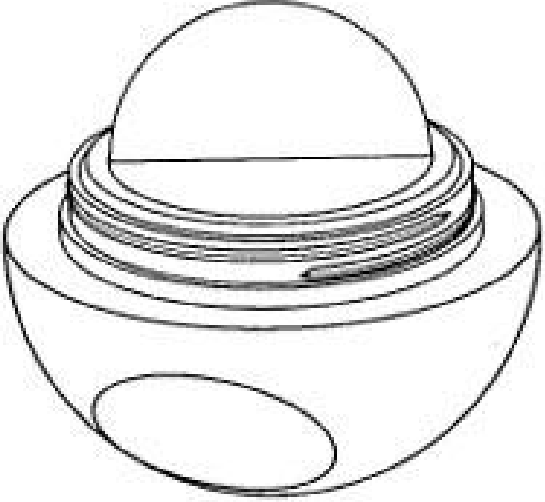
<b>DESIGN NUMBER</b>	257301	
<b>CLASS</b>	09-03	
<b>1)INTERNATIONAL COSMETIC SUPPLIERS LTD., A CORPORATION ORGANIZED AND EXISTING UNDER THE LAW OF TAIWAN, OF</b> 4F, #96, SECTION 1 CHIEN KUO NORTH ROAD, TAIPEI 10489, TAIWAN		
<b>DATE OF REGISTRATION</b>	08/10/2013	
<b>TITLE</b>	CONTAINER	
<b>PRIORITY NA</b>		

<b>DESIGN NUMBER</b>	257160		
<b>CLASS</b>	09-07		
<b>1)RECKITT BENCKISER LLC, A LIMITED LIABILITY COMPANY INCORPORATED IN THE STATE OF DELAWARE, U.S.A. OF</b> MORRIS CORPORATE CENTER IV, 399 INTERPACE PARKWAY, PARSIPPANY, NEW JERSEY 07054, U.S.A.			
<b>DATE OF REGISTRATION</b>	03/10/2013		
<b>TITLE</b>	DISPENSER		
<b>PRIORITY</b>			
<b>PRIORITY NUMBER</b>	<b>DATE</b>	<b>COUNTRY</b>	
002219253-0001	12/04/2013	OHIM	

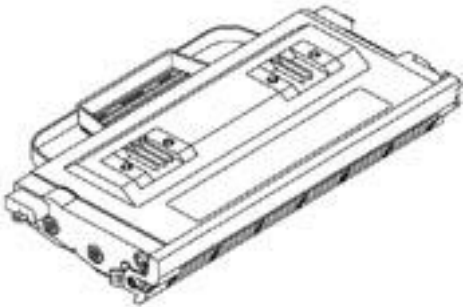
<b>DESIGN NUMBER</b>	258214		
<b>CLASS</b>	16-03		
<b>1)PANASONIC CORPORATION, A JAPANESE COMPANY ORGANIZED AND EXISTING UNDER THE LAWS OF JAPAN,</b> OF 1006, OAZA KADOMA, KADOMA-SHI, OSAKA 571-8501, JAPAN			
<b>DATE OF REGISTRATION</b>	19/11/2013		
<b>TITLE</b>	CARTRIDGE		
<b>PRIORITY</b>			
<b>PRIORITY NUMBER</b>	<b>DATE</b>	<b>COUNTRY</b>	
2013-010978	20/05/2013	JAPAN	

<b>DESIGN NUMBER</b>	259226		
<b>CLASS</b>	06-01		
<b>1)QUADRIFOGLIO SISTEMI D'ARREDO S.P.A., OF</b> VIA CORNARÈ, 12, 31040 MANSUE'. FRAZIONE BASALGHELLE - ITALY, AN ITALIAN JOINT STOCK COMPANY.			
<b>DATE OF REGISTRATION</b>	03/01/2014		
<b>TITLE</b>	BODY OF A CHAIR		
<b>PRIORITY</b>			
<b>PRIORITY NUMBER</b>	<b>DATE</b>	<b>COUNTRY</b>	
TV2013O000027	10/07/2013	ITALY	

<b>DESIGN NUMBER</b>	259320		
<b>CLASS</b>	09-03		
<b>1)HAMILTON HOUSEWARES PVT. LTD. AN INDIAN COMPANY INCORPORATED UNDER THE COMPANIES ACT 1956, HAVING REGISTERED OFFICE AT</b> KAISER-I-HIND BLDG., 3RD FLOOR, CURRIMBOY ROAD, BALLARD ESTATE, MUMBAI 400001, MAHARASHTRA, INDIA			
<b>DATE OF REGISTRATION</b>	10/01/2014		
<b>TITLE</b>	CONTAINER		
<b>PRIORITY NA</b>			

<b>DESIGN NUMBER</b>	259517		
<b>CLASS</b>	06-01		
<b>1)THE SUPREME INDUSTRIES LTD., (AN INDIAN PUBLIC LIMITED COMPANY),</b> 601 CENTRAL PLAZA, 2/6, SARAT BOSE ROAD, KOLKATA - 700020, WEST BENGAL, INDIA			
<b>DATE OF REGISTRATION</b>	20/01/2014		
<b>TITLE</b>	CHAIR		
<b>PRIORITY NA</b>			

<b>DESIGN NUMBER</b>	257247		
<b>CLASS</b>	12-16		
<b>1)VOLVO LASTVAGNAR AB, OF 405 08 GÖTEBORG, SWEDEN</b>			
<b>DATE OF REGISTRATION</b>	08/10/2013		
<b>TITLE</b>	GRILLE FOR VEHICLE		
<b>PRIORITY</b>			
<b>PRIORITY NUMBER</b>	<b>DATE</b>	<b>COUNTRY</b>	
002219360-0003	12/04/2013	OHIM	

<b>DESIGN NUMBER</b>	259267		
<b>CLASS</b>	06-08		
<b>1)KUSHAL KARYASHALA PRIVATE LIMITED (A COMPANY INCORPORATED UNDER THE INDIAN COMPANIES ACT 1956), 1, RAJ NAGAR ENCLAVE, PITAM PURA, DELHI-110034 (INDIA)</b>			
<b>DATE OF REGISTRATION</b>	07/01/2014		
<b>TITLE</b>	CLOTH HANGER		
<b>PRIORITY NA</b>			

<b>DESIGN NUMBER</b>	259778		
<b>CLASS</b>	07-02		
<b>1)EAGLE HOME APPLIANCES PVT. LTD., AN INDIAN COMPANY HAVING ADDRESS FOR SERVICE AT 4TH FLOOR, PARMAR GALLERY, SHIVARKAR ROAD, OPPOSITE PARMAR PARK, WANAWADI, PUNE 411040, MAHARASHTRA, INDIA</b>			
<b>DATE OF REGISTRATION</b>	29/01/2014		
<b>TITLE</b>	PRESSURE COOKER		
<b>PRIORITY NA</b>			

<b>DESIGN NUMBER</b>	256876	
<b>CLASS</b>	19-06	
<b>1)KOKUYO S&amp;T CO., LTD., A CORPORATION ORGANIZED AND EXISTING UNDER THE LAWS OF JAPAN, OF</b> 1-1, OIMAZATO-MINAMI 6-CHOME, HIGASHINARI-KU, OSAKA-SHI, OSAKA, JAPAN		
<b>DATE OF REGISTRATION</b>	27/09/2013	
<b>TITLE</b>	PEN	
<b>PRIORITY</b>		
<b>PRIORITY NUMBER</b>	<b>DATE</b>	<b>COUNTRY</b>
2013-007206	29/03/2013	JAPAN

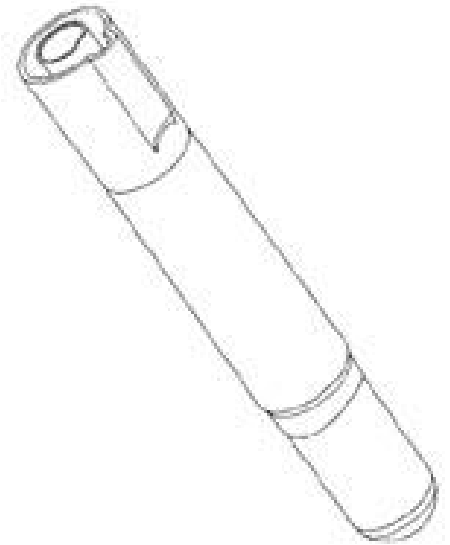

<b>DESIGN NUMBER</b>	257256	
<b>CLASS</b>	21-01	
<b>1)VOLVO LASTVAGNAR AB, OF</b> 405 08 GÖTEBORG, SWEDEN		
<b>DATE OF REGISTRATION</b>	08/10/2013	
<b>TITLE</b>	TOY TRUCK CAB	
<b>PRIORITY</b>		
<b>PRIORITY NUMBER</b>	<b>DATE</b>	<b>COUNTRY</b>
002219469-0001	12/04/2013	OHIM





<b>DESIGN NUMBER</b>	256483	
<b>CLASS</b>	11-02	
<b>1)MA DESIGN INDIA PRIVATE LIMITED, A COMPANY INCORPORATED IN INDIA HAVING ITS PRINCIPAL PLACE OF BUSINESS AT</b> A-41, SECTOR-80, PHASE-II, NOIDA-201305, U.P. INDIA		
<b>DATE OF REGISTRATION</b>	16/09/2013	
<b>TITLE</b>	DECORATIVE ARTICLE	
<b>PRIORITY NA</b>		

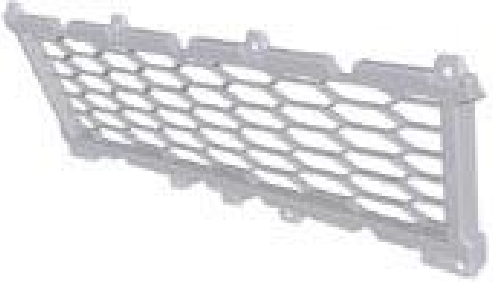

<b>DESIGN NUMBER</b>	259651	
<b>CLASS</b>	02-02	
<b>1)SWASTIKA GARMENTS OF 4, RAMKUMAR RAKSHIT LANE, KOLKATA-700 007, WEST BENGAL, INDIA, AN INDIAN PROPRIETORSHIP FIRM WHOSE PROPRIETOR IS BRIJGOPAL MUNDHARA, AN INDIAN OF THE ABOVE ADDRESS</b>		
<b>DATE OF REGISTRATION</b>	24/01/2014	
<b>TITLE</b>	GARMENT SET	
<b>PRIORITY NA</b>		

<b>DESIGN NUMBER</b>	257264		
<b>CLASS</b>	12-16		
<b>1)VOLVO LASTVAGNAR AB, OF 405 08 GÖTEBORG, SWEDEN</b>			
<b>DATE OF REGISTRATION</b>	08/10/2013		
<b>TITLE</b>	GRILLE FOR VEHICLE		
<b>PRIORITY</b>			
<b>PRIORITY NUMBER</b>	<b>DATE</b>	<b>COUNTRY</b>	
002219568-0007	12/04/2013	OHIM	

<b>DESIGN NUMBER</b>	257415		
<b>CLASS</b>	12-16		
<b>1)VOLVO LASTVAGNAR AB, OF SE 405 08 GÖTEBORG, SWEDEN</b>			
<b>DATE OF REGISTRATION</b>	10/10/2013		
<b>TITLE</b>	FENDER FOR VEHICLE		
<b>PRIORITY</b>			
<b>PRIORITY NUMBER</b>	<b>DATE</b>	<b>COUNTRY</b>	
2013/0170	11/04/2013	SWEDEN	

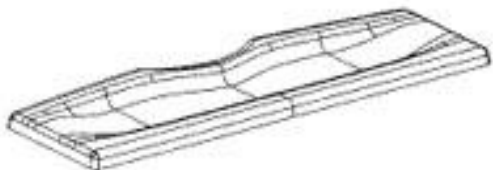
<b>DESIGN NUMBER</b>	258451		
<b>CLASS</b>	26-04		
<b>1)KONINKLIJKE PHILIPS N.V., A COMPANY ORGANIZED AND EXISTING UNDER THE LAWS OF THE KINGDOM OF THE NETHERLANDS, RESIDING AT EINDHOVEN,</b> WHOSE POST-OFFICE ADDRESS IS HIGH TECH CAMPUS 5, 5656 AE EINDHOVEN, THE NETHERLANDS			
<b>DATE OF REGISTRATION</b>	28/11/2013		
<b>TITLE</b>	LED BULB		
<b>PRIORITY</b>			
<b>PRIORITY NUMBER</b>	<b>DATE</b>	<b>COUNTRY</b>	
002282442-0003	26/07/2013	OHIM	
<b>DESIGN NUMBER</b>	257253		
<b>CLASS</b>	12-16		
<b>1)VOLVO LASTVAGNAR AB, OF 405 08 GÖTEBORG, SWEDEN</b>			
<b>DATE OF REGISTRATION</b>	08/10/2013		
<b>TITLE</b>	BUMPER FOR VEHICLE		
<b>PRIORITY</b>			
<b>PRIORITY NUMBER</b>	<b>DATE</b>	<b>COUNTRY</b>	
002219360-0009	12/04/2013	OHIM	
<b>DESIGN NUMBER</b>	259910		
<b>CLASS</b>	12-16		
<b>1)TATA MOTORS LIMITED, AN INDIAN COMPANY OF BOMBAY HOUSE, 24 HOMI MODY STREET, HUTATMA CHOWK, MUMBAI 400 001, MAHARASHTRA, INDIA</b>			
<b>DATE OF REGISTRATION</b>	31/01/2014		
<b>TITLE</b>	PARCEL TRAY OF A VEHICLE		
<b>PRIORITY NA</b>			

<b>DESIGN NUMBER</b>	258924	
<b>CLASS</b>	16-06	
1)CARL ZEISS MEDITEC AG, A CORPORATION ORGANIZED AND EXISTING UNDER THE LAWS OF GERMANY OF GOESCHWITZER STRASSE 51-52, 07745 JENA, GERMANY		
<b>DATE OF REGISTRATION</b>	23/12/2013	
<b>TITLE</b>	MICROSCOPE	
<b>PRIORITY</b>		
<b>PRIORITY NUMBER</b>	<b>DATE</b>	<b>COUNTRY</b>
001379713-0002	02/08/2013	OHIM



<b>DESIGN NUMBER</b>	259041	
<b>CLASS</b>	20-01	
1)LUNA TECHNOLOGY SYSTEMS LTS GMBH, INDUSTRIESTRASSE 19, 8304 WALLISELLEN, SWITZERLAND, NATIONALITY: SWITZERLAND		
<b>DATE OF REGISTRATION</b>	27/12/2013	
<b>TITLE</b>	CARTRIDGE FOR COFFEE MACHINES	
<b>PRIORITY</b>		
<b>PRIORITY NUMBER</b>	<b>DATE</b>	<b>COUNTRY</b>
761 415 401	12/09/2013	WIPO

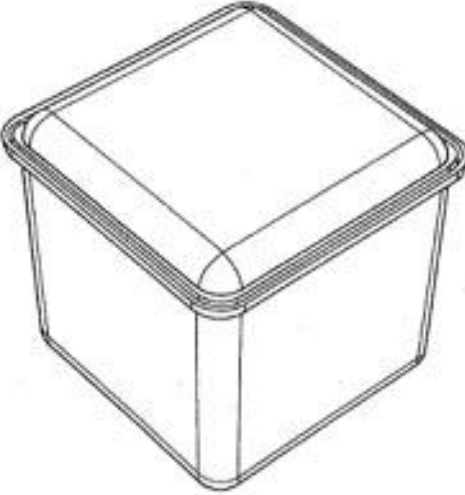

<b>DESIGN NUMBER</b>	259103	
<b>CLASS</b>	06-11	
1)HONDA ACCESS CORP., OF 18-4, 8-CHOME, NOBIDOME, NIIZA-SHI, SAITAMA, JAPAN		
<b>DATE OF REGISTRATION</b>	30/12/2013	
<b>TITLE</b>	A SET OF FLOOR MATS FOR VEHICLE	
<b>PRIORITY</b>		
<b>PRIORITY NUMBER</b>	<b>DATE</b>	<b>COUNTRY</b>
2013-016442	19/07/2013	JAPAN

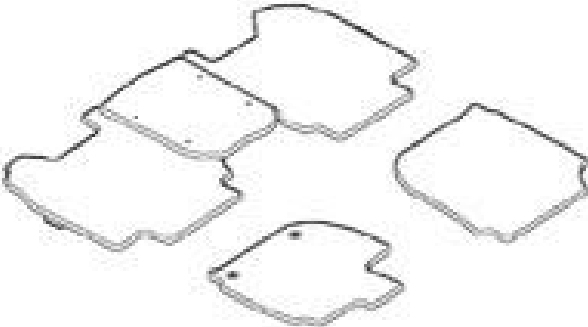





<b>DESIGN NUMBER</b>	257167	
<b>CLASS</b>	03-01	
<b>1)DOMINIK MAREK, OF ZA SOKOLOVNOU 601, 285 04 UHLIRSKÉ JANOVICE, CZECH REPUBLIC</b>		
<b>DATE OF REGISTRATION</b>	03/10/2013	
<b>TITLE</b>	SHOPPING BAG	
<b>PRIORITY NA</b>		

<b>DESIGN NUMBER</b>	258383	
<b>CLASS</b>	02-03	
<b>1)M/S STEELBIRD HI-TECH INDIA LIMITED, A COMPANY INCORPORATED UNDER THE COMPANIES ACT, 1956, HAVING ITS REGISTERED OFFICE AT B2B 17, NEAR METRO PILLAR 540, JANAK PURI, NEW DELHI-110058</b>		
<b>DATE OF REGISTRATION</b>	26/11/2013	
<b>TITLE</b>	HELMET	
<b>PRIORITY NA</b>		

<b>DESIGN NUMBER</b>	250968	
<b>CLASS</b>	25-01	
<b>1)KAMDHENU ISPAT LIMITED (A COMPANY INCORPORATED UNDER INDIAN COMPANIES ACT, 1956), 2ND FLOOR, BUILDING NO. 9A, DLF CYBER CITY, PHASE-3, GURGAON-122002, (INDIA)</b>		
<b>DATE OF REGISTRATION</b>	14/01/2013	
<b>TITLE</b>	ROD FOR CONSTRUCTION	
<b>PRIORITY NA</b>		

<b>DESIGN NUMBER</b>	259229		
<b>CLASS</b>	07-02		
<b>1)NARESH M. JAIN, PROPRIETOR-INDIAN NATIONAL, TRADING AS HAPPY HOME IMPEX, HAVING ITS REGISTERED OFFICE AT</b> BLDG. NO. 2, UNIT NO. 14, PARAM INDUSTRIAL ESTATE, NAIK PADA, VALIV, VASAI (EAST), THANE-401208, STATE OF MAHARASHTRA, INDIA, OF ABOVE ADDRESS			
<b>DATE OF REGISTRATION</b>	03/01/2014		
<b>TITLE</b>	CASSEROLE		
<b>PRIORITY NA</b>			
<b>DESIGN NUMBER</b>	259663		
<b>CLASS</b>	08-09		
<b>1)CHANDAN JAIN, AN INDIAN NATIONAL, OF THE ADDRESS</b> 6A, SESSION MARG, NEAR SAMARPAN HOSPITAL, KARNAL-132001, HARYANA, INDIA			
<b>DATE OF REGISTRATION</b>	24/01/2014		
<b>TITLE</b>	COVER OF THE DOOR CLOSER		
<b>PRIORITY NA</b>			
<b>DESIGN NUMBER</b>	259054		
<b>CLASS</b>	14-03		
<b>1)NOKIA CORPORATION, A FINNISH CORPORATION, OF THE ADDRESS KEILALAHDENTIE 4, ESPOO, FINLAND 02150</b>			
<b>DATE OF REGISTRATION</b>	27/12/2013		
<b>TITLE</b>	MOBILE PHONE		
<b>PRIORITY</b>			
<b>PRIORITY NUMBER</b>	<b>DATE</b>	<b>COUNTRY</b>	
29/464707	20/08/2013	U.S.A.	

<b>DESIGN NUMBER</b>	257469		
<b>CLASS</b>	08-06		
<b>1)JAYESHBHAI GANDUBHAI SARDHARA (ADULT &amp; INDIAN NATIONAL) PROPRIETOR OF MAHARAJA TECHNOCAST (INDIAN PROPRIETORSHIP CONCERN) HAVING PLACE OF BUSINESS AT:</b>			
4, PARSANA SOCIETY, 50 FEET MAIN ROAD, NR. SORATHIYAWADI CIRCLE, RAJKOT-360002-GUJARAT (INDIA)			
<b>DATE OF REGISTRATION</b>	14/10/2013		
<b>TITLE</b>	HANDLE		
<b>PRIORITY NA</b>			
<b>DESIGN NUMBER</b>	257254		
<b>CLASS</b>	12-16		
<b>1)VOLVO LASTVAGNAR AB, OF 405 08 GÖTEBORG, SWEDEN</b>			
<b>DATE OF REGISTRATION</b>	08/10/2013		
<b>TITLE</b>	BUMPER FOR VEHICLE		
<b>PRIORITY</b>			
<b>PRIORITY NUMBER</b>	<b>DATE</b>	<b>COUNTRY</b>	
002219360-0010	12/04/2013	OHIM	
<b>DESIGN NUMBER</b>	258452		
<b>CLASS</b>	26-04		
<b>1)KONINKLIJKE PHILIPS N.V., A COMPANY ORGANIZED AND EXISTING UNDER THE LAWS OF THE KINGDOM OF THE NETHERLANDS, RESIDING AT EINDHOVEN,</b>			
WHOSE POST-OFFICE ADDRESS IS HIGH TECH CAMPUS 5, 5656 AE EINDHOVEN, THE NETHERLANDS			
<b>DATE OF REGISTRATION</b>	28/11/2013		
<b>TITLE</b>	LED BULB		
<b>PRIORITY</b>			
<b>PRIORITY NUMBER</b>	<b>DATE</b>	<b>COUNTRY</b>	
002282392-0007	26/07/2013	OHIM	

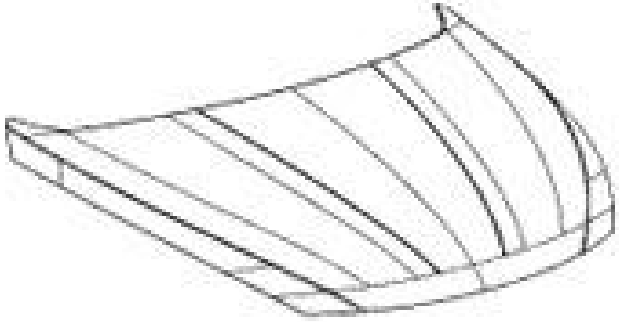
<b>DESIGN NUMBER</b>	259912	
<b>CLASS</b>	12-16	
<b>1)TATA MOTORS LIMITED, AN INDIAN COMPANY OF BOMBAY HOUSE, 24 HOMI MODY STREET, HUTATMA CHOWK, MUMBAI 400 001, MAHARASHTRA, INDIA</b>		
<b>DATE OF REGISTRATION</b>	31/01/2014	
<b>TITLE</b>	HOOD OF A VEHICLE	
<b>PRIORITY NA</b>		

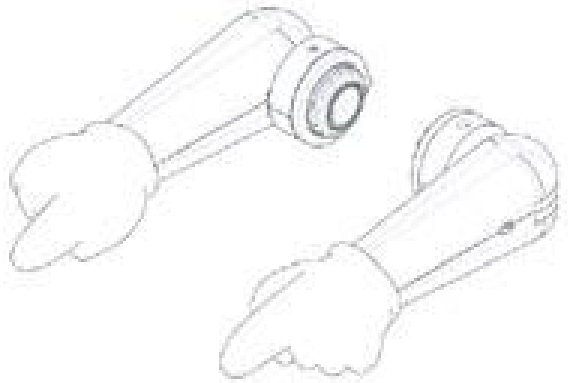
<b>DESIGN NUMBER</b>	257902	
<b>CLASS</b>	02-03	
<b>1)ALDRIN ERROL JOHN, 19 NGOBIT STREET, SUNNINGHILL, JOHANNESBURG, 2157, SOUTH AFRICA, NATIONALITY-SOUTH AFRICA</b>		
<b>DATE OF REGISTRATION</b>	31/10/2013	
<b>TITLE</b>	ATTACHMENT FOR HAT (SET)	
<b>PRIORITY NA</b>		

<b>DESIGN NUMBER</b>	257263	
<b>CLASS</b>	12-16	
<b>1)VOLVO LASTVAGNAR AB, OF 405 08 GÖTEBORG, SWEDEN</b>		
<b>DATE OF REGISTRATION</b>	08/10/2013	
<b>TITLE</b>	GRILLE FOR VEHICLE	
<b>PRIORITY</b>		
<b>PRIORITY NUMBER</b>	<b>DATE</b>	
002219568-0006	12/04/2013	OHIM

<b>DESIGN NUMBER</b>	257414	
<b>CLASS</b>	12-16	
1)VOLVO LASTVAGNAR AB, OF SE 405 08 GÖTEBORG, SWEDEN.		
<b>DATE OF REGISTRATION</b>	10/10/2013	
<b>TITLE</b>	FENDER FOR VEHICLE	
<b>PRIORITY</b>		
<b>PRIORITY NUMBER</b>	<b>DATE</b>	<b>COUNTRY</b>
2013/0169	11/04/2013	SWEDEN



<b>DESIGN NUMBER</b>	257248	
<b>CLASS</b>	12-16	
1)VOLVO LASTVAGNAR AB, OF 405 08 GÖTEBORG, SWEDEN		
<b>DATE OF REGISTRATION</b>	08/10/2013	
<b>TITLE</b>	FRONT PANEL FOR VEHICLE	
<b>PRIORITY</b>		
<b>PRIORITY NUMBER</b>	<b>DATE</b>	<b>COUNTRY</b>
002219360-0004	12/04/2013	OHIM

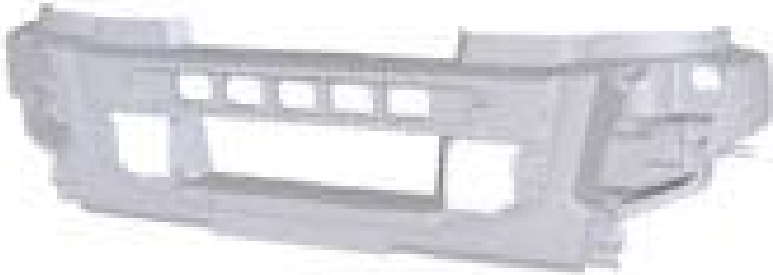

<b>DESIGN NUMBER</b>	259270	
<b>CLASS</b>	12-16	
1)DEERE & COMPANY, A US CORPORATION OF ONE JOHN DEERE PLACE, MOLINE, ILLINOIS, 61265-8098 USA		
<b>DATE OF REGISTRATION</b>	07/01/2014	
<b>TITLE</b>	ROLL OVER PROTECTION STRUCTURE FOR OFF-ROAD VEHICLES	
<b>PRIORITY NA</b>		

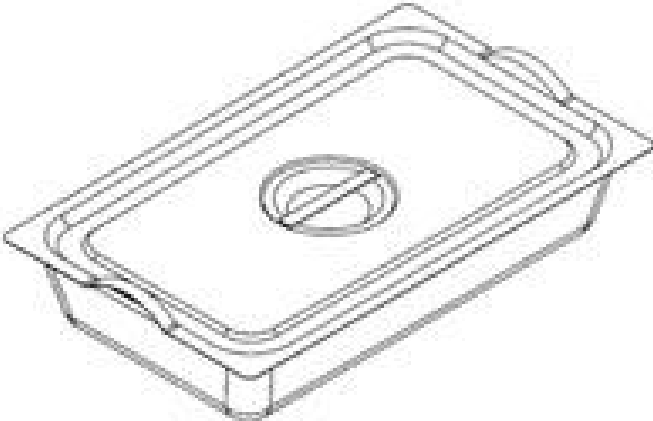

<b>DESIGN NUMBER</b>	259783		
<b>CLASS</b>	07-02		
<b>1)EAGLE HOME APPLIANCES PVT. LTD., AN INDIAN COMPANY HAVING ADDRESS FOR SERVICE AT 4TH FLOOR, PARMAR GALLERY, SHIVARKAR ROAD, OPPOSITE PARMAR PARK, WANAWADI, PUNE 411040, MAHARASHTRA, INDIA</b>			
<b>DATE OF REGISTRATION</b>	29/01/2014		
<b>TITLE</b>	TIFFIN BOX		
<b>PRIORITY NA</b>			
<b>DESIGN NUMBER</b>	259573		
<b>CLASS</b>	05-05		
<b>1)PARRY MURRAY &amp; CO. LTD., COMPANY REGISTERED UNDER THE LAWS OF ENGLAND AND WALES, HAVING ITS PRINCIPAL PLACE OF BUSINESS AT 3RD FLOOR, SIMPSON HOUSE, 6 CHERRY ORCHARD ROAD, CROYDON, CRO 6BA, UNITED KINGDOM</b>			
<b>DATE OF REGISTRATION</b>	22/01/2014		
<b>TITLE</b>	TEXTILE FABRIC		
<b>PRIORITY NA</b>			
<b>DESIGN NUMBER</b>	259056		
<b>CLASS</b>	14-03		
<b>1)NOKIA CORPORATION, A FINNISH CORPORATION OF THE ADDRESS KEILALAHDENTIE 4, ESPOO, FINLAND 02150</b>			
<b>DATE OF REGISTRATION</b>	27/12/2013		
<b>TITLE</b>	MOBILE PHONE COVER		
<b>PRIORITY</b>			
<b>PRIORITY NUMBER</b>	<b>DATE</b>	<b>COUNTRY</b>	
29/465240	26/08/2013	U.S.A.	

<b>DESIGN NUMBER</b>	259665	
<b>CLASS</b>	09-03	
<b>1)DONG-MYUNG KIM,</b> 1225-101 HANYANG MOKRYEON APT., 25 SANBON-RO, 432BEON-GIL, GUNPO-SI, GYEONGGI-DO, 435-040, REPUBLIC OF KOREA, NATIONALITY: REPUBLIC OF KOREA		
<b>DATE OF REGISTRATION</b>	24/01/2014	
<b>TITLE</b>	FOOD STORAGE CONTAINER	
<b>PRIORITY NA</b>		

<b>DESIGN NUMBER</b>	257580	
<b>CLASS</b>	26-05	
<b>1)M/S SHREE SANT KRIPA INTELLECTUAL, HAVING OFFICE AT</b> 7, AKSHAY COMPLEX, OFF. DHOLE PATIL ROAD, PUNE-411001, MAHARASHTRA, INDIA, AN INDIAN		
<b>DATE OF REGISTRATION</b>	21/10/2013	
<b>TITLE</b>	CEILING FIXTURES FOR LAMPS	
<b>PRIORITY NA</b>		

<b>DESIGN NUMBER</b>	257748	
<b>CLASS</b>	12-08	
<b>1)DR. ING. H.C.F. PORSCHE AKTIENGESELLSCHAFT, A</b> <b>GERMAN COMPANY OF</b> PORSCHEPLATZ 1, 70435 STUTTGART, GERMANY		
<b>DATE OF REGISTRATION</b>	25/10/2013	
<b>TITLE</b>	CAR	
<b>PRIORITY NA</b>		