

INTRODUCTION

In view of the recent amendment made in the Designs (Amendment) Rules, 2008 with effect from 17/06/2008, Publication of the matter relating to Designs is being published in the Official Journal of The Patent Office. This Journal is being published on weekly basis on every Friday covering the various proceedings on Designs as required according to the provisions of under Rule 22, 25, 27 and 39 of the Design (Amendment) Rules, 2008. All the enquiries on this Official Journal and other information as required by the public should be addressed to the Controller General of Patents, Designs & Trade Marks. Suggestions and comments are requested from all quarters so that the content can be enriched.

DESIGN
CORRIGENDUM

(01)

The Registered Design No. 226802 which has been erroneously published in the official Journal of India dated 24/12/2010, part –II , at page 5224, column 1 in the name of LPG Finance Industrie 26 Rue Docteur Henri Abel, 26000 Valence, France Class 28-03, Date of Registration 18/01/2010, Titled as Head For Massage Apparatus, Priority Number 1584525-0006, Date 16/07/2009, Country OHIM should read as LPG Finance Industrie 26 Rue Docteur Henri Abel, 26000 Valence, France Class 28-03, Date of Registration 18/01/2010, Titled as Head For Massage Apparatus, Priority Number 1584525-0007, Date 16/07/2009, Country OHIM

(02)

The Registered Design No. 226804 which has been erroneously published in the official Journal of India dated 05/08/2011, part –II , at page 5, column 2 in the name of LPG Finance Industrie 26 Rue Docteur Henri Abel, 26000 Valence, France Class 28-03, Date of Registration 18/01/2010, Titled as Head For Massage Apparatus, Priority Number 1584525-0007, Date 16/07/2009, Country OHIM should read as LPG Finance Industrie 26 Rue Docteur Henri Abel, 26000 Valence, France Class 28-03, Date of Registration 18/01/2010, Titled as Head For Massage Apparatus, Priority Number 1584525-0006, Date 16/07/2009, Country OHIM

COPYRIGHT PUBLICATION

SL NO	REGISTERED DESIGN NUMBERS	RENEWED ON
1.	198649	19.08.2014
2.	199440	18.08.2014
3.	199526	21.08.2014
4.	199994	18.08.2014
5.	201706	18.08.2014
6.	202100	18.08.2014
7.	202119	18.08.2014
8.	202120	18.08.2014
9.	202121	18.08.2014
10.	202122	18.08.2014
11.	202801	18.08.2014
12.	202802	18.08.2014
13.	202803	18.08.2014
14.	206236	19.08.2014
15.	206341	18.08.2014
16.	206342	18.08.2014
17.	207852	19.08.2014
18.	207853	21.08.2014
19.	208062	19.08.2014
20.	208063	19.08.2014

REGISTRATION OF DESIGNS

The following designs have been registered. They are now open for public inspection. In the following each entry the Date of Registration is shown. The Priority Number, Priority Date and Priority Country are also shown

DESIGN NUMBER	258494	
CLASS	12-05	
1)KONE CORPORATION, A COMPANY ORGANIZED AND EXISTING UNDER THE LAWS OF FINLAND, OF THE ADDRESS KARTANONTIE 1, 00330 HELSINKI, FINLAND		
DATE OF REGISTRATION	29/11/2013	
TITLE	CONTROL PANEL FOR HOISTS, LIFTS AND ELEVATORS	
PRIORITY		
PRIORITY NUMBER	DATE	
002249573-0001	05/06/2013	OHIM
DESIGN NUMBER	258116	
CLASS	19-06	
1)NIYATI ENTERPRISE., (AN INDIAN SOLE PROPRIETORSHIP CONCERN), HAVING OFFICE AT 223/224, RAJ RATNA INDUSTRIAL ESTATE, 2ND FLOOR, OPP. S. N. D. T. COLLEGE, MALAD (WEST), MUMBAI-400064, MAHARASHTRA, INDIA. WHOSE PROPRIETOR IS DINESH KHAKHAR. (INDIAN NATIONAL) OF ABOVE ADDRESS		
DATE OF REGISTRATION	13/11/2013	
TITLE	PEN	
PRIORITY NA		
DESIGN NUMBER	240707	
CLASS	07-02	
1)GAS SAFE INDIA MARKETING, 421, EAST WING, AURORA TOWERS, PUNE CAMP, PUNE-411001, MAHARASHTRA, INDIA.		
DATE OF REGISTRATION	11/11/2011	
TITLE	GAS STOVE	
PRIORITY NA		

DESIGN NUMBER	256161
CLASS	13-03
1)GURPAL INTERNATIONAL, C-33, DSIDC PACKAGING COMPLEX, DELHI-110015, INDIA. (AN INDIAN PROPRIETORSHIP FIRM WHOSE PROPRIETOR IS:- MPS BHATIA AN INDIAN NATIONAL OF THE ABOVE ADDRESS	
DATE OF REGISTRATION	02/09/2013
TITLE	INVERTOR
PRIORITY NA	



DESIGN NUMBER	255006	
CLASS	25-01	
1)ODENWALD FASERPLATTENWERK GMBH, OF DR.-F.-A.-FREUNDT-STRASSE 3, 63916 AMORBACH, GERMANY, A GERMAN COMPANY		
DATE OF REGISTRATION	04/07/2013	
TITLE	CEILING PANEL	
PRIORITY		
PRIORITY NUMBER	DATE	COUNTRY
DM/081 110	04/01/2013	WIPO

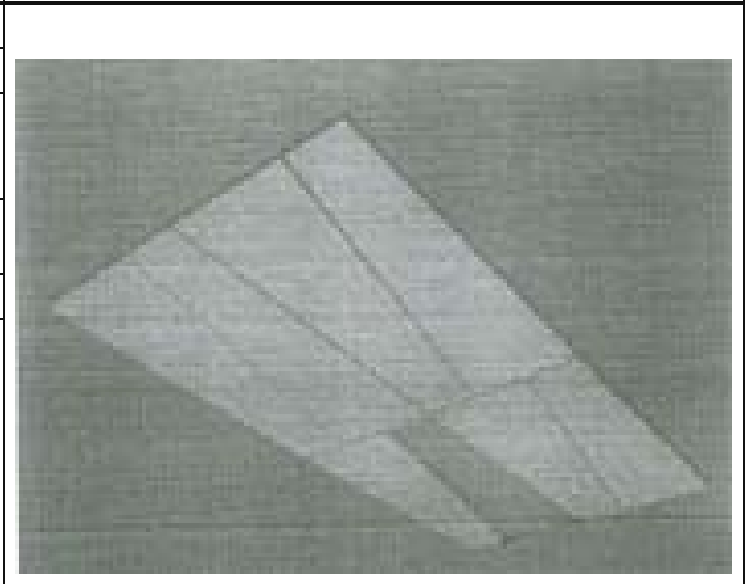

DESIGN NUMBER	255890	
CLASS	13-03	
1)PHOENIX CONTACT GMBH & CO. KG; A GERMAN COMPANY OF BRUNO MUTH, FLACHSMARKTSTR. 8, D-32825 BLOMBERG, GERMANY		
DATE OF REGISTRATION	19/08/2013	
TITLE	ELECTRIC CONNECTOR	
PRIORITY		
PRIORITY NUMBER	DATE	COUNTRY
002190058-0005	22/02/2013	OHIM

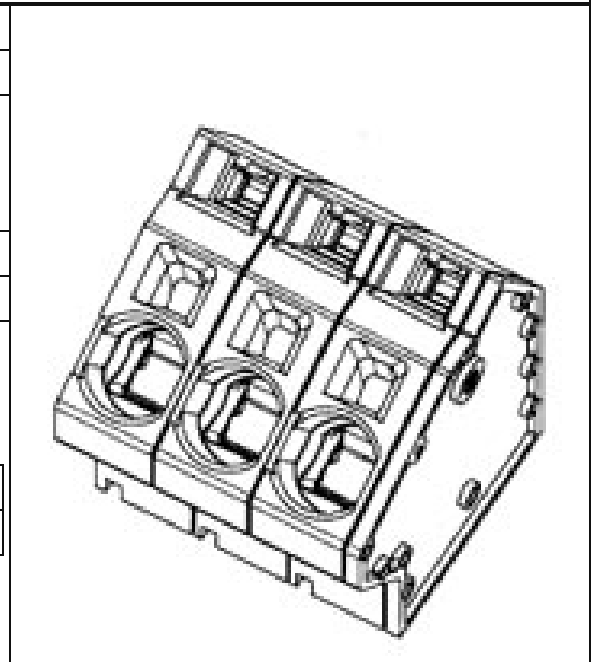

DESIGN NUMBER	252848	
CLASS	24-01	
1)ATOMO DIAGNOSTICS PTY LIMITED, A CORPORATION ORGANIZED AND EXISTING UNDER THE LAWS OF AUSTRALIA WHOSE ADDRESS IS 21, MARLBOROUGH STREET, DRUMMOYNE NSW 2047, AUSTRALIA		
DATE OF REGISTRATION	03/04/2013	
TITLE	MEDICAL DEVICE FOR TESTING FLUID SAMPLES	
PRIORITY		
PRIORITY NUMBER	DATE	COUNTRY
14942/2012	03/10/2012	AUSTRALIA

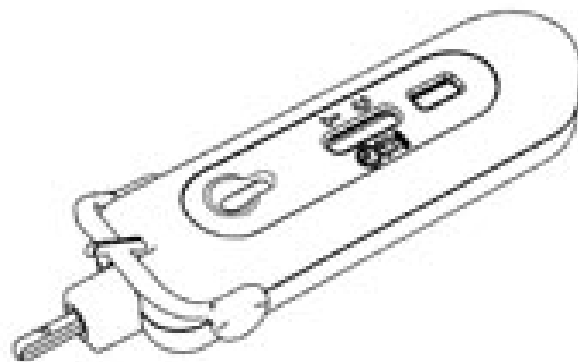





DESIGN NUMBER	259661	
CLASS	28-02	
1)PRAKRITI NATURALS IS A PROPRIETORSHIP FIRM OF RAGHUKUL, D-14/101, CHITTARANJAN NAGAR CHS, BEFORE ONGC COLONY, VIDHYAVIHAR (E), MUMBAI-400056, MAHARASHTRA, INDIA		
DATE OF REGISTRATION	24/01/2014	
TITLE	SOAP	
PRIORITY NA		

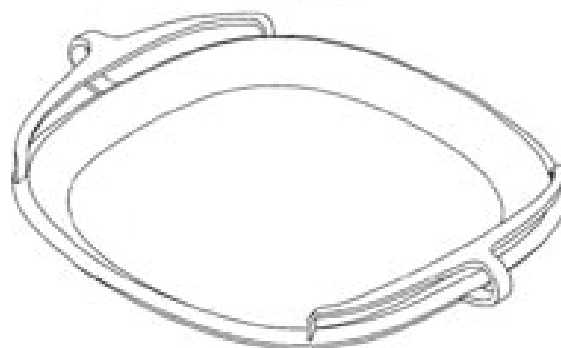



DESIGN NUMBER	257965	
CLASS	07-02	
1)LENOX CORPORATION, 1414 RADCLIFFE STREET, BISTOL, PA 19007, UNITED STATES OF AMERICA, NATIONALITY: UNITED STATES OF AMERICA		
DATE OF REGISTRATION	04/11/2013	
TITLE	SERVING VESSEL	
PRIORITY		
PRIORITY NUMBER	DATE	COUNTRY
29/453,789	02/05/2013	U.S.A.

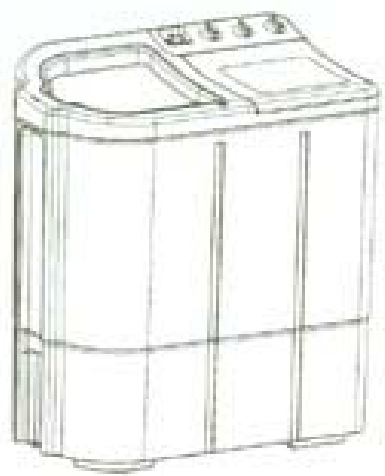

DESIGN NUMBER	256899			
CLASS	26-04			
1)KONINKLIJKE PHILIPS N.V., A COMPANY ORGANIZED AND EXISTING UNDER THE LAWS OF THE KINGDOM OF THE NETHERLANDS, RESIDING AT EINDHOVEN, WHOSE POST-OFFICE ADDRESS IS HIGH TECH CAMPUS 5, 5656 AE EINDHOVEN, THE NETHERLANDS				
DATE OF REGISTRATION	30/09/2013			
TITLE	LED BULB			
PRIORITY				
PRIORITY NUMBER	DATE	COUNTRY		
002242891-0006	23/05/2013	OHIM		
PRIORITY NA				
PRIORITY NA				
DESIGN NUMBER	259790			
CLASS	25-01			
1)SIMS CERAMIC PVT. LTD. OF ORSUN CERAMIC ZONE, LAKHADHIRPUR ROAD, 8-A, NATIONAL HIGHWAY, MORBI-363642, GUJARAT, INDIA, INDIAN COMPANY				
DATE OF REGISTRATION	29/01/2014			
TITLE	TILE			
PRIORITY NA				
PRIORITY NA				
DESIGN NUMBER	258655			
CLASS	09-03			
1)MANJUSHREE TECHNOPACK LIMITED, OF 143, C-5, BOMMASANDRA INDUSTRIAL AREA, HOSUR ROAD, BANGALORE-560099, KARNATAKA, INDIA, AN INDIAN COMPANY				
DATE OF REGISTRATION	10/12/2013			
TITLE	JAR			
PRIORITY NA				
PRIORITY NA				

DESIGN NUMBER	257919	
CLASS	06-08	
1)TFS GLOBAL HANGER MANAGEMENT GMBH, A COMPANY UNDER GERMAN LAW OF HOHER WEG 2, 48513 NORDHORN, GERMANY		
DATE OF REGISTRATION	31/10/2013	
TITLE	CLOTHES HANGER	
PRIORITY NA		

DESIGN NUMBER	258971	
CLASS	15-05	
1)VIDEOCON INDUSTRIES LIMITED. A COMPANY INCORPORATED UNDER THE INDIAN COMPANIES ACT, AT 14 KMS. STONE, AURANGABAD-PAITHAN ROAD, CHITEGAON, TQ.PAITHAN, DIST. AURANGABAD-431105, MAHARASHTRA, INDIA.		
DATE OF REGISTRATION	24/12/2013	
TITLE	WASHING MACHINE	
PRIORITY NA		

DESIGN NUMBER	257352	
CLASS	07-01	
1)RAVISSANT PRIVATE LIMITED, AN INDIAN COMPANY, OF 50-51, COMMERCIAL COMPLEX, NEW FRIENDS COLONY, NEW DELHI-110065, INDIA		
DATE OF REGISTRATION	09/10/2013	
TITLE	POT	
PRIORITY NA		

DESIGN NUMBER	255975
CLASS	23-03
1)THE ABELL FOUNDATION, INC., A CORPORATION OF MARYLAND, SUITE 2300, 111 S. CALVERT STREET, BALTIMORE, MD 21202-6174	
DATE OF REGISTRATION	22/08/2013
TITLE	CONDENSER HEAT EXCHANGER PLATE

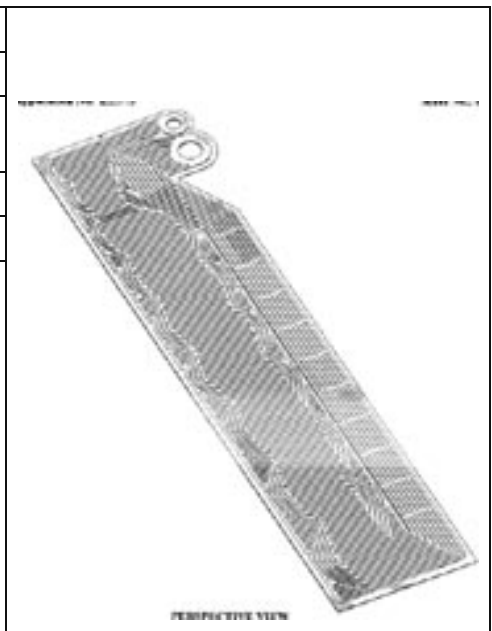

PRIORITY

PRIORITY NUMBER	DATE	COUNTRY
29/442,396	22/02/2013	U.S.A.

DESIGN NUMBER	258036
CLASS	18-04
1)PRATICHHAYA PVT. LTD., AN INDIAN COMPANY INCORPORATED UNDER THE INDIAN COMPANIES ACT, 1956, HAVING ITS ADDRESS AT 227, SUKHDEV VIHAR, NEW DELHI-110025, INDIA	
DATE OF REGISTRATION	07/11/2013
TITLE	BOOK BINDING MACHINE
PRIORITY NA	



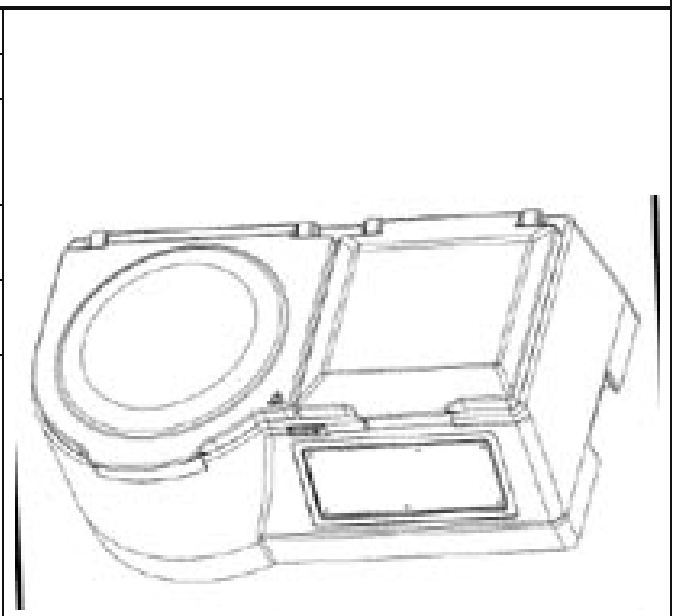

DESIGN NUMBER	257661
CLASS	24-01
1)ORTHO-CLINICAL DIAGNOSTICS, INC., A CORPORATION OF THE STATE OF NEW YORK, OF 1001 U.S. ROUTE 202, RARITAN, NJ 08869, U.S.A.	
DATE OF REGISTRATION	22/10/2013
TITLE	IMMUNOHEMATOLOGY MANUAL WORK STATION



PRIORITY

PRIORITY NUMBER	DATE	COUNTRY
29/452,874	23/04/2013	U.S.A.

DESIGN NUMBER	257924	
CLASS	06-08	
1)TFS GLOBAL HANGER MANAGEMENT GMBH, A COMPANY UNDER GERMAN LAW OF HOHER WEG 2, 48513 NORDHORN, GERMANY		
DATE OF REGISTRATION	31/10/2013	
TITLE	CLOTHES HANGER	
PRIORITY NA		
DESIGN NUMBER	258554	
CLASS	31-00	
1)JOHNY A.A. (INDIAN) PROPRIETOR OF M/S SUN INDUSTRIES, 6 JARNA MIT CHOWKI, OFF LINK ROAD, MALAD WEST, MUMBAI-64, INDIA		
DATE OF REGISTRATION	04/12/2013	
TITLE	COCONUT SCRAPER	
PRIORITY NA		
DESIGN NUMBER	255660	
CLASS	13-03	
1)ARGHA INFOSFT SOLUTIONS PVT. LTD., A PRIVATE LIMITED COMPANY, HAVING ITS REGISTERED OFFICE AT NO: A 305, 2ND FLOOR, BLOCK 1, KSSIDC COMPLEX, ELECTRONIC CITY, BANGALORE-560100, KARNATAKA, INDIA		
DATE OF REGISTRATION	06/08/2013	
TITLE	SWITCH	
PRIORITY NA		



DESIGN NUMBER	259374	
CLASS	09-03	
1)SUNIL B. SHAH AN INDIAN NATIONAL SOLE PROPRIETOR OF PARASNATH FOOD PRODUCTS AN INDIAN PROPRIETORSHIP FIRM HAVING ITS PRINCIPAL PLACE OF BUSINESS AT UNDER JAIN UPASRYA, AMRUTSERI, VALSAD-396001, GUJARAT-INDIA		
DATE OF REGISTRATION	13/01/2014	
TITLE	CONTAINER	
PRIORITY NA		
DESIGN NUMBER	259704	
CLASS	12-16	
1)HERO MOTOCORP LIMITED, AN INDIAN COMPANY INCORPORATED UNDER THE COMPANIES ACT, HAVING ITS OFFICE AT 34, COMMUNITY CENTRE, BASANT LOK, VASANT VIHAR, NEW DELHI-110057		
DATE OF REGISTRATION	27/01/2014	
TITLE	WHEEL	
PRIORITY NA		
DESIGN NUMBER	258658	
CLASS	07-07	
1)NAYASA SUPERPLAST OF SURVEY NO. 370/2 (7) KACHIGAM, NANI DAMAN, DAMAN-396210, (UNION TERRITORIES), INDIA, INDIAN PARTNERSHIP FIRM, WHOSE PARTNERS ARE SACHIN SACHDEV & MANASI SACHDEV, ALL INDIAN NATIONALS		
DATE OF REGISTRATION	11/12/2013	
TITLE	LAUNDRY BASKET	
PRIORITY NA		

DESIGN NUMBER	257923		
CLASS	06-08		
1)TFS GLOBAL HANGER MANAGEMENT GMBH, A COMPANY UNDER GERMAN LAW OF HOHER WEG 2, 48513 NORDHORN, GERMANY			
DATE OF REGISTRATION	31/10/2013		
TITLE	CLOTHES HANGER		
PRIORITY NA			
DESIGN NUMBER	256408		
CLASS	12-13		
1)POLARIS INDUSTRIES INC., A CORPORATION ORGANIZED UNDER THE LAWS OF THE UNITED STATES OF AMERICA, OF 2100 HIGHWAY 55, MEDINA, MINNESOTA 55340-9770, THE UNITED STATES OF AMERICA			
DATE OF REGISTRATION	13/09/2013		
TITLE	ALL TERRAIN VEHICLE		
PRIORITY			
PRIORITY NUMBER	DATE	COUNTRY	
29/449,479	15/03/2013	U.S.A.	
DESIGN NUMBER	258896		
CLASS	26-06		
1)HONDA MOTOR CO., LTD., A JAPANESE CORPORATION, OF 1-1, MINAMI-AOYAMA 2-CHOME, MINATO-KU, TOKYO, 107-8556, JAPAN			
DATE OF REGISTRATION	20/12/2013		
TITLE	REAR LAMP FOR AUTOMOBILE		
PRIORITY			
PRIORITY NUMBER	DATE	COUNTRY	
2013-014749	28/06/2013	JAPAN	

DESIGN NUMBER	257354	
CLASS	07-01	
1)RAVISSANT PRIVATE LIMITED, AN INDIAN COMPANY, OF 50-51, COMMERCIAL COMPLEX, NEW FRIENDS COLONY, NEW DELHI-110065, INDIA		
DATE OF REGISTRATION	09/10/2013	
TITLE	POT	
PRIORITY NA		

DESIGN NUMBER	259558		
CLASS	24-99		
1)C. R. BARD, INC., A CORPORATION ORGANIZED AND EXISTING UNDER THE LAWS OF THE STATE OF NEW JERSEY, OF 730 CENTRAL AVENUE, MURRAY HILL, NEW JERSEY 07974, U.S.A.			
DATE OF REGISTRATION	22/01/2014		
TITLE	TISSUE MARKER FOR INTRACORPOREAL SITE IDENTIFICATION		
PRIORITY			
PRIORITY NUMBER	DATE	COUNTRY	
29/467,895	24/09/2013	U.S.A.	

DESIGN NUMBER	257925	
CLASS	06-08	
1)TFS GLOBAL HANGER MANAGEMENT GMBH, A COMPANY UNDER GERMAN LAW OF HOHER WEG 2, 48513 NORDHORN, GERMANY		
DATE OF REGISTRATION	31/10/2013	
TITLE	CLOTHES HANGER	
PRIORITY NA		

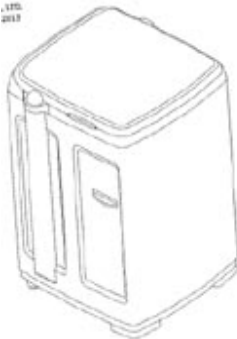
DESIGN NUMBER	253604		
CLASS	08-08		
1)SB INGENIERIE, A FRENCH COMPANY OF 76 CHEMIN DES POSES, F-74330 POISY, FRANCE (FR)			
DATE OF REGISTRATION	01/05/2013		
TITLE	ATTACHMENT DEVICE		
PRIORITY			
PRIORITY NUMBER	DATE	COUNTRY	
002130476	05/11/2012	OHIM	
DESIGN NUMBER	258653		
CLASS	13-03		
1)ARUN ENTERPRISES, B-48, SITE-4, INDUSTRIAL AREA, SHAHIBABAD, DIST.-GHAZIABAD-201010, UTTAR PRADESH, INDIA. (AN INDIAN PARTNERSHIP FIRM WHOSE PARTNERS ARE:- SH. C. L. DHIR, SH. ARUN DHIR, SH. TARUN DHIR. AN INDIAN NATIONAL OF THE ABOVE ADDRESS			
DATE OF REGISTRATION	10/12/2013		
TITLE	CONNECTOR FOR ELECTRICAL CABLES		
PRIORITY NA			
DESIGN NUMBER	258890		
CLASS	15-05		
1)SAMSUNG ELECTRONICS CO., LTD., A KOREAN COMPANY, OF 129, SAMSUNG-RO, YEONGTONG-GU, SUWON-SI, GYEONGGI-DO, 443-742, REPUBLIC OF KOREA			
DATE OF REGISTRATION	20/12/2013		
TITLE	WASHING MACHINE		
PRIORITY			
PRIORITY NUMBER	DATE	COUNTRY	
30-2013-0032141	21/06/2013	KOREA(SOUTH)	

DESIGN NUMBER	258652	
CLASS	13-03	
1)ARUN ENTERPRISES, B-48, SITE-4, INDUSTRIAL AREA, SHAHIBABAD, DIST.-GHAZIABAD-201010, UTTAR PRADESH, INDIA. (AN INDIAN PARTNERSHIP FIRM WHOSE PARTNERS ARE:- SH. C. L. DHIR, SH. ARUN DHIR, SH. TARUN DHIR. AN INDIAN NATIONAL OF THE ABOVE ADDRESS		
DATE OF REGISTRATION	10/12/2013	
TITLE	CONNECTOR FOR ELECTRICAL CABLES	
PRIORITY NA		
DESIGN NUMBER	255888	
CLASS	13-03	
1)PHOENIX CONTACT GMBH & CO. KG; A GERMAN COMPANY OF BRUNO MUTH, FLACHSMARKTSTR. 8, D-32825 BLOMBERG, GERMANY		
DATE OF REGISTRATION	19/08/2013	
TITLE	ELECTRIC CONNECTOR	
PRIORITY		
PRIORITY NUMBER	DATE	COUNTRY
002190058-0003	22/02/2013	OHIM
DESIGN NUMBER	256630	
CLASS	09-01	
1)SAVERGLASS, A FRENCH COMPANY OF 3 RUE DE LA GARE, 60960 FEUQUIERES, FRANCE		
DATE OF REGISTRATION	20/09/2013	
TITLE	BOTTLE	
PRIORITY		
PRIORITY NUMBER	DATE	COUNTRY
002232553-0001	06/05/2013	OHIM

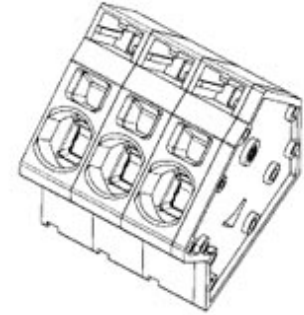

DESIGN NUMBER	259775	
CLASS	26-06	
1)FORD GLOBAL TECHNOLOGIES, LLC A COMPANY ORGANIZED AND EXISTING UNDER THE LAWS OF UNITED STATES OF AMERICA, HAVING ITS OFFICE AT 330 TOWN CENTER DRIVE, SUITE 800, DEARBORN MICHIGAN-48126, UNITED STATES OF AMERICA		
DATE OF REGISTRATION	28/01/2014	
TITLE	VEHICLE TAIL LAMP LENS	
PRIORITY		
PRIORITY NUMBER	DATE	COUNTRY
201330381162.0	09/08/2013	CHINA
DESIGN NUMBER	257758	
CLASS	12-16	
1)JCB INDIA LIMITED, AN INDIAN COMPANY HAVING ITS REGISTERED OFFICE AT B-1/1-1, 2ND FLOOR, MOHAN CO-OPERATIVE INDUSTRIAL ESTATE, MATHURA ROAD, NEW DELHI, INDIA AND WORKS AT 23/7, MATHURA ROAD, BALLABGARH, HARYANA, INDIA		
DATE OF REGISTRATION	25/10/2013	
TITLE	CHASSIS FOR SKID STEER LOADER	
PRIORITY NA		
DESIGN NUMBER	257964	
CLASS	07-02	
1)LENOX CORPORATION, 1414 RADCLIFFE STREET, BISTOL, PA 19007, UNITED STATES OF AMERICA, NATIONALITY: UNITED STATES OF AMERICA		
DATE OF REGISTRATION	04/11/2013	
TITLE	SERVING VESSEL	
PRIORITY		
PRIORITY NUMBER	DATE	COUNTRY
29/453,789	02/05/2013	U.S.A.



DESIGN NUMBER	258898	
CLASS	12-16	
1)HONDA MOTOR CO., LTD., A JAPANESE CORPORATION, OF 1-1, MINAMI-AOYAMA 2-CHOME, MINATO-KU, TOKYO, 107-8556, JAPAN		
DATE OF REGISTRATION	20/12/2013	
TITLE	GRILL FOR AUTOMOBILE	
PRIORITY		
PRIORITY NUMBER	DATE	COUNTRY
2013-014752	28/06/2013	JAPAN

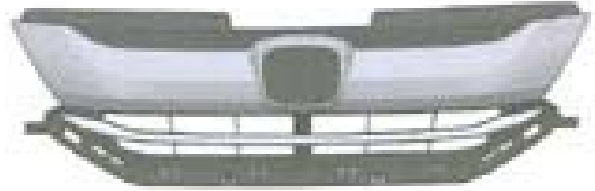



DESIGN NUMBER	260194	
CLASS	08-07	
1)KELVIN V. GUNJARIYA AN INDIAN NATIONAL SOLE PROPRIETOR OF KAIZON PRODUCTS AN INDIAN PROPRIETORSHIP FIRM HAVING ITS PRINCIPAL PLACE OF BUSINESS AT L-4124/1, PHASE-IV, GIDC, VATVA, AHMEDABAD-382445, GUJARAT-INDIA		
DATE OF REGISTRATION	07/02/2014	
TITLE	DOOR LATCH	
PRIORITY NA		





DESIGN NUMBER	259560	
CLASS	12-16	
1)HONDA MOTOR CO., LTD., A JAPANESE CORPORATION, OF 1-1, MINAMI-AOYAMA 2-CHOME, MINATO-KU, TOKYO, JAPAN		
DATE OF REGISTRATION	22/01/2014	
TITLE	FRONT SIDE COWL FOR MOTOR SCOOTER	
PRIORITY		
PRIORITY NUMBER	DATE	COUNTRY
2013-016973	25/07/2013	JAPAN

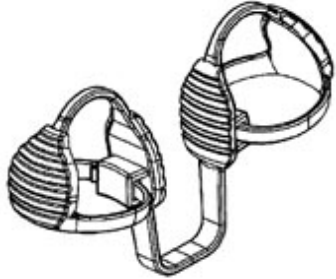
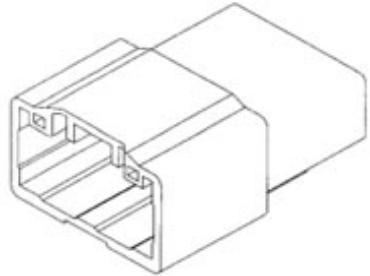

DESIGN NUMBER	253359		
CLASS	19-02		
1)NOK CORPORATION, A JAPANESE CORPORATION OF 12-15, SHIBA DAIMON 1-CHOME, MINATO-KU, TOKYO 105-8585, JAPAN			
DATE OF REGISTRATION	23/04/2013		
TITLE	SEAL TO PREVENT LEAKAGE OF LIQUIDS		
PRIORITY			
PRIORITY NUMBER	DATE	COUNTRY	
2012-026327	30/10/2012	JAPAN	
DESIGN NUMBER	256689		
CLASS	06-05		
1)WIPRO ENTERPRISES LIMITED, A COMPANY REGISTERED UNDER THE COMPANIES ACT 1956 HAVING ITS REGISTERED OFFICE AT #134, DODDAKANNELLI, SARJAPUR ROAD, BANGALORE-560035; NATIONALITY : INDIAN			
DATE OF REGISTRATION	23/09/2013		
TITLE	CLASSROOM DESK CUM CHAIR SET		
PRIORITY NA			
DESIGN NUMBER	259723		
CLASS	12-16		
1)FORD GLOBAL TECHNOLOGIES, LLC A COMPANY ORGANIZED AND EXISTING UNDER THE LAWS OF UNITED STATES OF AMERICA, HAVING ITS OFFICE AT 330 TOWN CENTER DRIVE, SUITE 800, DEARBORN MICHIGAN-48126, UNITED STATES OF AMERICA			
DATE OF REGISTRATION	27/01/2014		
TITLE	VEHICLE FRONT LOWER BUMPER COVER		
PRIORITY			
PRIORITY NUMBER	DATE	COUNTRY	
201330380092.7	09/08/2013	CHINA	

DESIGN NUMBER	258684	
CLASS	07-02	
1)SUMIT KISHAN SHARMA, MAXIM EXIM (INDIA), MCF-2093, SECTOR-23, SANJAY COLONY, FARIDABAD-121001. (INDIA) AS INDIAN NATIONAL		
DATE OF REGISTRATION	12/12/2013	
TITLE	GAS STOVE	
PRIORITY NA		
DESIGN NUMBER	257233	
CLASS	07-02	
1)SHREE VALLABH METALS., (A PARTNERSHIP FIRM REGISTERED UNDER INDIAN PARTNERSHIP ACT, 1932) AT 17/21, DR. ATMARAM MERCHANT ROAD, BHONABHAI CHAWL, BHULESHWAR, MUMBAI-400002. MAHARASHTRA, INDIA. WHOSE PARTNERS ARE (1) DHAVAL JAIN. (INDIAN NATIONAL), (2) SHANTILAL JAIN. (INDIAN NATIONAL), (3) VIMALCHAND JAIN. (INDIAN NATIONAL), (4) BHARATKUMAR JAIN. (INDIAN NATIONAL) & (5) MR. BHAVESH JAIN. (INDIAN NATIONAL), ALL ARE HAVING ABOVE ADDRES		
DATE OF REGISTRATION	07/10/2013	
TITLE	CASSEROLE	
PRIORITY NA		
DESIGN NUMBER	259529	
CLASS	05-05	
1)SATHEESAN V C/O AVID APPAREL INDUSTRIES, B-17, SECTOR-58 NOIDA-201301 (UP) INDIA, INDIAN		
DATE OF REGISTRATION	20/01/2014	
TITLE	TEXTILE FABRIC	
PRIORITY NA		

DESIGN NUMBER	255356		
CLASS	24-02		
1)ASAP BREATHEASSIST PTY LTD., AN AUSTRALIAN COMPANY OF LEVEL 9, 45 WILLIAM STREET, MELBOURNE, VIC, 3000, AUSTRALIA			
DATE OF REGISTRATION	19/07/2013		
TITLE	NASAL DILATOR DEVICE		
PRIORITY			
PRIORITY NUMBER	DATE	COUNTRY	
10288/2013	21/01/2013	AUSTRALIA	
DESIGN NUMBER	258685		
CLASS	13-03		
1)YAZAKI CORPORATION, A JAPANESE CORPORATION OF 4-28, MITA 1-CHOME, MINATO-KU, TOKYO 108-8333, JAPAN			
DATE OF REGISTRATION	11/12/2013		
TITLE	HOUSING FOR ELECTRIC CONNECTOR		
PRIORITY			
PRIORITY NUMBER	DATE	COUNTRY	
2013-013291	12/06/2013	JAPAN	
DESIGN NUMBER	258897		
CLASS	26-06		
1)HONDA MOTOR CO., LTD., A JAPANESE CORPORATION, OF 1-1, MINAMI-AOYAMA 2-CHOME, MINATO-KU, TOKYO, 107-8556, JAPAN			
DATE OF REGISTRATION	20/12/2013		
TITLE	FRONT LAMP FOR AUTOMOBILE		
PRIORITY			
PRIORITY NUMBER	DATE	COUNTRY	
2013-014748	28/06/2013	JAPAN	

DESIGN NUMBER	245029	
CLASS	24-02	
1)OCCLUTECH HOLDING AG VORDERGASSE 3, CH-8201 SCHAFFHAUSEN, SWITZERLAND		
DATE OF REGISTRATION	30/04/2012	
TITLE	OCCLUSAL APPLIANCES	
PRIORITY		
PRIORITY NUMBER	DATE	COUNTRY
001940610-0004	31/10/2011	OHIM

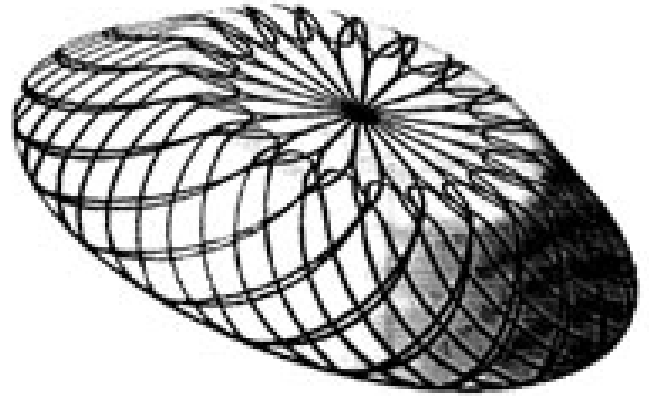

DESIGN NUMBER	257367	
CLASS	07-01	
1)RAVISSANT PRIVATE LIMITED, AN INDIAN COMPANY, OF 50-51, COMMERCIAL COMPLEX, NEW FRIENDS COLONY, NEW DELHI-110065, INDIA		
DATE OF REGISTRATION	09/10/2013	
TITLE	TEA POT	
PRIORITY NA		





DESIGN NUMBER	255752	
CLASS	12-08	
1)SUZUKI MOTOR CORPORATION, A JAPANESE CORPORATION OF 300, TAKATSUKA-CHO, MINAMI-KU, HAMAMATSU-SHI, SHIZUOKA-KEN, JAPAN		
DATE OF REGISTRATION	12/08/2013	
TITLE	CAR	
PRIORITY		
PRIORITY NUMBER	DATE	COUNTRY
2013-002727	13/02/2013	JAPAN

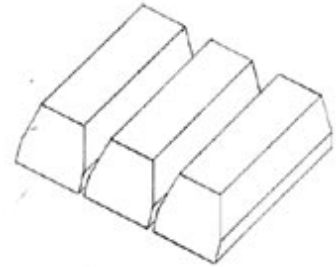

DESIGN NUMBER	255490		
CLASS	16-06		
1)PATRICK C. HO, A US CITIZEN, HAVING ITS OFFICE AT 4, QUAIL RUN, HILTON, NY 14468, UNITED STATES OF AMERICA			
DATE OF REGISTRATION	29/07/2013		
TITLE	EYEGLOSS FRAME		
PRIORITY			
PRIORITY NUMBER	DATE	COUNTRY	
29/444,325	29/01/2013	U.S.A.	
DESIGN NUMBER	259559		
CLASS	12-16		
1)HONDA MOTOR CO., LTD., A JAPANESE CORPORATION, OF 1-1, MINAMI-AOYAMA 2-CHOME, MINATO-KU, TOKYO, JAPAN			
DATE OF REGISTRATION	22/01/2014		
TITLE	FRONT SIDE COWL FOR MOTORCYCLE		
PRIORITY			
PRIORITY NUMBER	DATE	COUNTRY	
2013-017458	31/07/2013	JAPAN	
DESIGN NUMBER	254360		
CLASS	12-08		
1)FORD MOTOR COMPANY A COMPANY ORGANIZED AND EXISTING UNDER THE LAWS OF UNITED STATES OF AMERICA, HAVING ITS OFFICE AT DEARBORN, COUNTY OF WAYNE, STATE OF MICHIGAN, UNITED STATES OF AMERICA, AND FORD OTOMOTIV SANAYI ANONIM SIRKETI A COMPANY ORGANIZED AND EXISTING UNDER THE LAWS OF REPUBLIC OF TURKEY, HAVING ITS OFFICE AT AKPINAR MAHALLESİ, HASAN BASRI CADDESİ NO. 2, SANCAKTEPE, ISTANBUL, TURKEY			
DATE OF REGISTRATION	06/06/2013		
TITLE	TRUCK		
PRIORITY			
PRIORITY NUMBER	DATE	COUNTRY	
29/443,888	23/01/2013	U.S.A.	

DESIGN NUMBER	253989	
CLASS	07-01	
1)BONJOUR INTERNATIONAL, A INDIAN PARTNERSHIP FIRM OF 15 UA JAWAHAR NAGAR, DELHI-110007, INDIA, WHOSE PARTNERS ARE (1) RAMAN GUPTA OF 385, DEEPALI, PITAMPURA, DELHI-110034 (2) RAJESH KUMAR GUPTA OF 384, DEEPALI, PITAMPURA, DELHI-110034 AND (3) REENA GUPTA OF 384, DEEPALI, PITAMPURA, DELHI-110034 ALL INDIAN NATIONALS		
DATE OF REGISTRATION	20/05/2013	
TITLE	FLASK	
PRIORITY NA		
DESIGN NUMBER	256113	
CLASS	17-01	
1)SYDNEY MATHEWS, A CANADIAN NATIONAL OF THE ADDRESS 200 RIDEAU TERRACE, APT 1403 OTTAWA, ONTARIO K1M 0Z3, CANADA		
DATE OF REGISTRATION	29/08/2013	
TITLE	PIANO KEY	
PRIORITY		
PRIORITY NUMBER	DATE	COUNTRY
152140	23/07/2013	CANADA
DESIGN NUMBER	259679	
CLASS	15-03	
1)M/S DHIMAN INDUSTRIES, 1ST FLOOR, HUNJAN COMPLEX, G.N.E. TO DUGRI, SUA ROAD, LUDHIANA-141003 (PUNJAB) INDIA AN INDIAN PROPRIETORSHIP FIRM WHOSE PROPRIETOR IS SHERANJIT KAUR BEING INDIAN NATIONALS OF THE ABOVE ADDRESS		
DATE OF REGISTRATION	27/01/2014	
TITLE	SUGAR CANE LEAF REMOVER MACHINE	
PRIORITY NA		

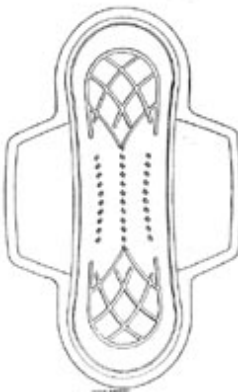

DESIGN NUMBER	259726		
CLASS	12-16		
1)FORD GLOBAL TECHNOLOGIES, LLC A COMPANY ORGANIZED AND EXISTING UNDER THE LAWS OF UNITED STATES OF AMERICA, HAVING ITS OFFICE AT 330 TOWN CENTER DRIVE, SUITE 800, DEARBORN MICHIGAN-48126, UNITED STATES OF AMERICA			
DATE OF REGISTRATION	27/01/2014		
TITLE	VEHICLE FRONT LOWER GRILLE		
PRIORITY			
PRIORITY NUMBER	DATE	COUNTRY	
201330381524.6	09/08/2013	CHINA	
DESIGN NUMBER	254256		
CLASS	09-01		
1)GURUJI THANDAIWALA PVT. LTD. A COMPANY REGISTERED UNDER COMPANIES ACT 1956 HAVING ITS REGISTERED OFFICE AT, 149 COTTON STREET, KOLKATA 700007, KOLKATA HAVING ITS PRINCIPAL PLACE OF BUSINESS AT KOLKATA, INDIA BY NATIONALITY INDIAN			
DATE OF REGISTRATION	03/06/2013		
TITLE	BOTTLE WITH CAP		
PRIORITY NA			
DESIGN NUMBER	225566		
CLASS	24-04		
1)JOHNSON & JOHNSON IND. E COM. LTDA RODOVIA PRESIDENTS DUTRA, KM-154, SAO JOSE DOS CAMPOS, SAO PAULO CEP 12237-350 BRAZIL,			
DATE OF REGISTRATION	29/10/2009		
TITLE	SANITARY NAPKIN		
PRIORITY			
PRIORITY NUMBER	DATE	COUNTRY	
29/336110	29/04/2009	U.S.A.	

DESIGN NUMBER	259100	
CLASS	06-11	
1)HONDA ACCESS CORP., OF 18-4, 8-CHOME, NOBIDOME, NIIZA-SHI, SAITAMA, JAPAN		
DATE OF REGISTRATION	30/12/2013	
TITLE	FLOOR MAT FOR VEHICLE	
PRIORITY		
PRIORITY NUMBER	DATE	COUNTRY
2013-016439	19/07/2013	JAPAN

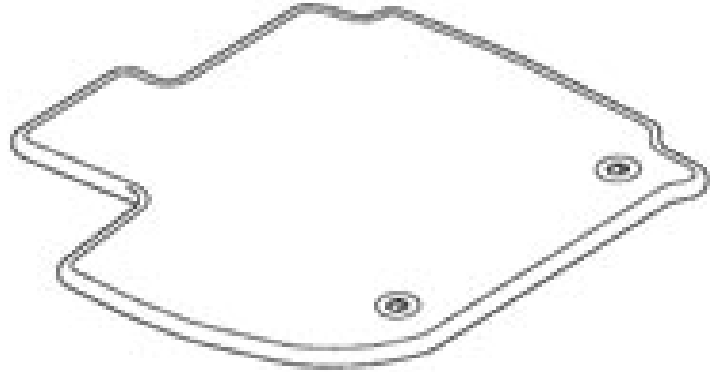





DESIGN NUMBER	259530	
CLASS	05-05	
1)SATHEESAN V C/O AVID APPAREL INDUSTRIES, B-17, SECTOR-58 NOIDA-201301 (UP) INDIA, INDIAN		
DATE OF REGISTRATION	20/01/2014	
TITLE	TEXTILE FABRIC	
PRIORITY NA		





DESIGN NUMBER	259563	
CLASS	26-06	
1)HONDA MOTOR CO., LTD., A JAPANESE CORPORATION, OF 1-1, MINAMI-AOYAMA 2-CHOME, MINATO-KU, TOKYO, JAPAN		
DATE OF REGISTRATION	22/01/2014	
TITLE	HEADLIGHT FOR MOTORCYCLE	
PRIORITY		
PRIORITY NUMBER	DATE	COUNTRY
2013-017459	31/07/2013	JAPAN

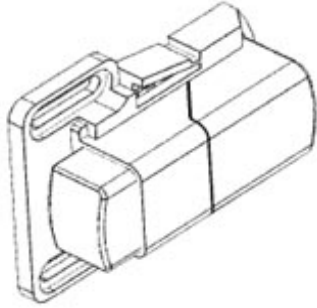

DESIGN NUMBER	259677		
CLASS	19-02		
1)KANIN (INDIA) AT B-XXX-6754, FOCAL POINT, LUDHIANA-141010, PUNJAB, INDIA, AN INDIAN PARTNERSHIP FIRM, WHOSE PARTNERS ARE ARIHANT JAIN, VISHWA JAIN, MS. NEELAM JAIN, AMBRISH JAIN, GAUTAM JAIN AND AMIT JAIN (ALL INDIAN NATIONALS) HAVING THEIR ADDRESS OF B-XXX-6754, FOCAL POINT, LUDHIANA-141010, PUNJAB			
DATE OF REGISTRATION	27/01/2014		
TITLE	STAPLER		
PRIORITY			
PRIORITY NUMBER	DATE	COUNTRY	
002362939	02/12/2013	OHIM	
DESIGN NUMBER	259725		
CLASS	12-16		
1)FORD GLOBAL TECHNOLOGIES, LLC A COMPANY ORGANIZED AND EXISTING UNDER THE LAWS OF UNITED STATES OF AMERICA, HAVING ITS OFFICE AT 330 TOWN CENTER DRIVE, SUITE 800, DEARBORN MICHIGAN-48126, UNITED STATES OF AMERICA			
DATE OF REGISTRATION	27/01/2014		
TITLE	VEHICLE FRONT UPPER BUMPER COVER		
PRIORITY			
PRIORITY NUMBER	DATE	COUNTRY	
201330380154.4	09/08/2013	CHINA	
DESIGN NUMBER	258690		
CLASS	13-02		
1)SU-KAM POWER SYSTEMS LTD. OF PLOT NO. WZ-1401/2, NANGAL RAYA, NEW DELHI-110046, INDIA, AN INDIAN COMPANY			
DATE OF REGISTRATION	11/12/2013		
TITLE	SOLAR POWER CONDITIONING UNIT		
PRIORITY NA			

DESIGN NUMBER	257940		
CLASS	13-03		
1)STEGO-HOLDING GMBH, KOLPINGSTRASSE 21, 74523 SCHWAEBISCH HALL, GERMANY, NATIONALITY-GERMAN			
DATE OF REGISTRATION	01/11/2013		
TITLE	DOOR CONTACT SWITCH		
PRIORITY			
PRIORITY NUMBER	DATE	COUNTRY	
2236802	14/05/2013	OHIM	
DESIGN NUMBER	259151		
CLASS	13-03		
1)AI-AZIZ PLASTICS PVT. LTD., COMPANY REGISTERED WHOSE ADDRESS 125, AMAR INDL. ESTATE, A. K. ROAD, SAKINAKA, ANDHERI-(E), MUMBAI-400072			
DATE OF REGISTRATION	31/12/2013		
TITLE	JUNCTION BOX		
PRIORITY NA			
DESIGN NUMBER	259536		
CLASS	05-05		
1)SATHEESAN V C/O AVID APPAREL INDUSTRIES, B-17, SECTOR-58 NOIDA-201301 (UP) INDIA, INDIAN			
DATE OF REGISTRATION	20/01/2014		
TITLE	TEXTILE FABRIC		
PRIORITY NA			

DESIGN NUMBER	258192		
CLASS	09-01		
1)MNR DAIRY FARMS, A COMPANY REGISTERED UNDER THE COMPANIES ACT 1956 HAVING ITS REGISTERED OFFICE AT THE PLOT NO. 101/A, 1ST FLOOR, JOURNALIST COLONY, JUBILEE HILLS, HYDERABAD-500033, ANDHRA PRADESH, INDIA			
DATE OF REGISTRATION	18/11/2013		
TITLE	BOTTLE		
PRIORITY NA			
DESIGN NUMBER	258711		
CLASS	08-05		
1)ENRIQUE VERA ANDRADES, AN SPANISH HAVING ITS PRINCIPAL PLACE OF BUSINESS AT C/LINAJE, 2-3°-A 29001-MALAGA-SPAIN BY SPANISH			
DATE OF REGISTRATION	12/12/2013		
TITLE	RAKE		
PRIORITY NA			
DESIGN NUMBER	256138		
CLASS	12-13		
1)POLARIS INDUSTRIES INC., A CORPORATION ORGANIZED UNDER THE LAWS OF THE UNITED STATES OF AMERICA, OF 2100 HIGHWAY 55, MEDINA, MINNESOTA 55340, THE UNITED STATES OF AMERICA			
DATE OF REGISTRATION	30/08/2013		
TITLE	VEHICLE FOR ALL TERRAINS		
PRIORITY			
PRIORITY NUMBER	DATE	COUNTRY	
29/447,346	01/03/2013	U.S.A.	

DESIGN NUMBER	259152
CLASS	13-03
1)AI-AZIZ PLASTICS PVT. LTD., COMPANY REGISTERED WHOSE ADDRESS 125, AMAR INDL. ESTATE, A. K. ROAD, SAKINAKA, ANDHERI-(E), MUMBAI-400072	
DATE OF REGISTRATION	31/12/2013
TITLE	JUNCTION BOX
PRIORITY NA	

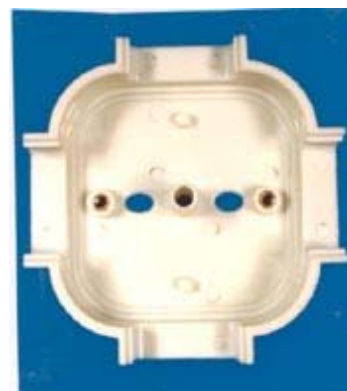



DESIGN NUMBER	259359
CLASS	10-04
1)MOONLIGHT ENGINEERING CO. A PARTNERSHIP FIRM AT 2, KUMARPARA ROAD, RAJPUR, KOLKATA-700149, WEST BENGAL, INDIA, WHERE THE PARTNERS ARE DHRUBAPADA NEOGI, SOUMEN KUMAR NEOGI, SAMIR KUMAR NEOGI, SANDIP KUMAR NEOGI, SANJIB KUMAR NEOGI, SUKANTA NEOGI, SURAJIT NEOGI, SUBHRA NEOGI, RUNU NEOGI ALL AT THE ABOVE ADDRESS AND ALL ARE INDIAN NATIONALS	
DATE OF REGISTRATION	13/01/2014
TITLE	MEASURING SYSTEM FOR LIQUID
PRIORITY NA	



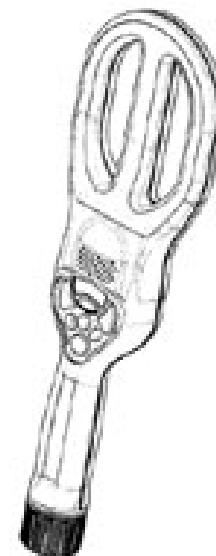

DESIGN NUMBER	259470	
CLASS	10-05	
1)COSTRUZIONI ELETTRONICHE INDUSTRIALI AUTOMATISMI S.P.A. C.E.I.A. S.P.A., AN ITALIAN CORPORATION, WHOSE ADDRESS IS CIVITELLA IN VAL DI CHIANA (AR), VIA STRADA PROVINCIALE PESCAIOLA, 54/G-56 CAP, I-52040 FRAZIONE VICIOMAGGIO, ITALY		
DATE OF REGISTRATION	17/01/2014	
TITLE	METAL DETECTOR	
PRIORITY		
PRIORITY NUMBER	DATE	COUNTRY
002283010-0001	29/07/2013	OHIM

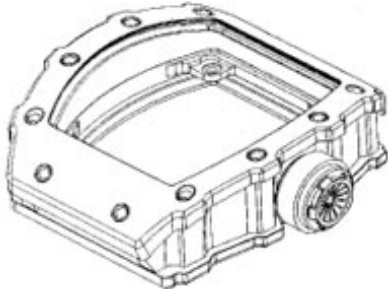

DESIGN NUMBER	259537		
CLASS	05-05		
1)SATHEESAN V C/O AVID APPAREL INDUSTRIES, B-17, SECTOR-58 NOIDA-201301 (UP) INDIA, INDIAN			
DATE OF REGISTRATION	20/01/2014		
TITLE	TEXTILE FABRIC		
PRIORITY NA			
DESIGN NUMBER	259163		
CLASS	14-03		
1)AUDI AG GERMAN LAW, OF 85045 INGOLSTADT, GERMANY			
DATE OF REGISTRATION	31/12/2013		
TITLE	CASING FOR REMOTE CONTROLS		
PRIORITY			
PRIORITY NUMBER	DATE	COUNTRY	
002272211-0002	09/07/2013	OHIM	
DESIGN NUMBER	259690		
CLASS	10-02		
1)TURLEN HOLDING SA, A SWISS COMPANY, C/O SIPO S.A., CHEMIN DU CHÂTEAU 26A, 2805 SOYHIÈRES, SWITZERLAND			
DATE OF REGISTRATION	27/01/2014		
TITLE	WATCHCASE		
PRIORITY			
PRIORITY NUMBER	DATE	COUNTRY	
775321301	19/11/2013	WIPO	

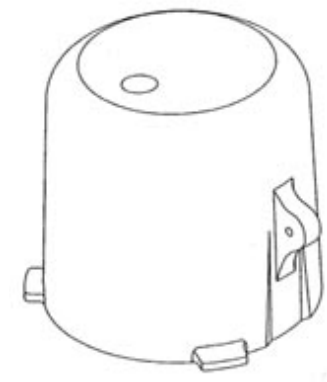
DESIGN NUMBER	259150	
CLASS	13-03	
1)AI-AZIZ PLASTICS PVT. LTD., COMPANY REGISTERED WHOSE ADDRESS 125, AMAR INDL. ESTATE, A. K. ROAD, SAKINAKA, ANDHERI-(E), MUMBAI-400072		
DATE OF REGISTRATION	31/12/2013	
TITLE	JUNCTION BOX	
PRIORITY NA		
DESIGN NUMBER	259467	
CLASS	08-06	
1)KAPILBHAI BALVANTRAI VYAS AND JIGNESHBHAI CHHAGANBHAI GOHEL BOTH INDIAN NATIONAL PARTNER OF RATNAPRABHA HARDWARE AN INDIAN PARTNERSHIP FIRM HAVING ITS PRINCIPAL PLACE OF BUSINESS AT ADDRESS:- 6, PARSANA SOCIETY, 50 FEET ROAD, KOTHARIYA MAIN ROAD, RAJKOT-2. GUJARAT-INDIA		
DATE OF REGISTRATION	17/01/2014	
TITLE	HANDLE	
PRIORITY NA		
DESIGN NUMBER	259535	
CLASS	05-05	
1)SATHEESAN V C/O AVID APPAREL INDUSTRIES, B-17, SECTOR-58 NOIDA-201301 (UP) INDIA, INDIAN		
DATE OF REGISTRATION	20/01/2014	
TITLE	TEXTILE FABRIC	
PRIORITY NA		

DESIGN NUMBER	259865		
CLASS	08-07		
1)BRADY WORLDWIDE, INC. 2221 WEST CAMDEN ROAD, MILWAUKEE, WISCONSIN - 53209, UNITED STATES OF AMERICA, A WISCONSIN CORPORATION			
DATE OF REGISTRATION	30/01/2014		
TITLE	LOCKING DEVICE COVER		
PRIORITY			
PRIORITY NUMBER	DATE	COUNTRY	
29/462,126	31/07/2013	U.S.A.	
DESIGN NUMBER	258710		
CLASS	08-01		
1)ENRIQUE VERA ANDRADES, AN SPANISH HAVING ITS PRINCIPAL PLACE OF BUSINESS AT C/LINAJE, 2-3º-A 29001-MALAGA-SPAIN BY SPANISH			
DATE OF REGISTRATION	12/12/2013		
TITLE	SHOVEL		
PRIORITY NA			
DESIGN NUMBER	254405		
CLASS	24-02		
1)PRASHANT INDUSTRIES IS A PROPRIETORSHIP FIRM OF PASHAN FLAT, A/2 BLDG, FLAT NO. 14, SUS ROAD, PASHAN, PUNE-411021, MAHARASHTRA, INDIA			
DATE OF REGISTRATION	10/06/2013		
TITLE	CHEMICAL PURIFIED MACHINE		
PRIORITY NA			

DESIGN NUMBER	257399	
CLASS	12-16	
1)VOLVO LASTVAGNAR AB, OF SE 405 08 GÖTEBORG, SWEDEN.		
DATE OF REGISTRATION	10/10/2013	
TITLE	BUMPER COMPONENT FOR VEHICLE	
PRIORITY		
PRIORITY NUMBER	DATE	COUNTRY
2013/0150	11/04/2013	SWEDEN



DESIGN NUMBER	259762	
CLASS	23-04	
1)USHA INTERNATIONAL LIMITED, AN INDIAN COMPANY INCORPORATED UNDER THE COMPANIES ACT, 1956 HAVING ITS REGISTERED OFFICE AT SURYA KIRAN BUILDING, 19 KASTURBA GANDHI MARG, NEW DELHI-110001, INDIA		
DATE OF REGISTRATION	28/01/2014	
TITLE	FAN	
PRIORITY NA		



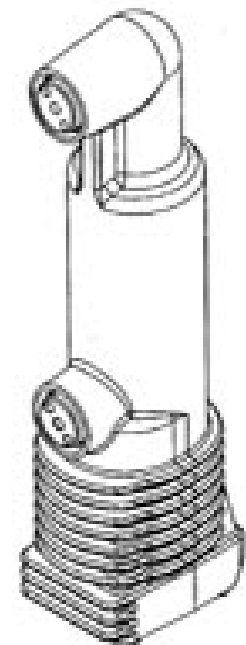

DESIGN NUMBER	254265	
CLASS	13-03	
1)ABB TECHNOLOGY AG, A SWISS COMPANY OF, AFFOLTERNSTR. 44, 8050 ZURICH, SWITZERLAND		
DATE OF REGISTRATION	05/06/2013	
TITLE	VACUUM INTERRUPTERS	
PRIORITY		
PRIORITY NUMBER	DATE	COUNTRY
002147918-0001	05/12/2012	OHIM

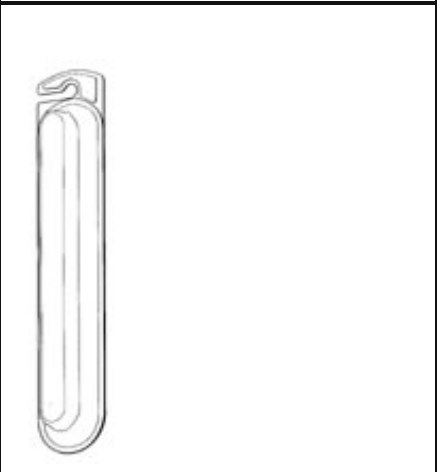

DESIGN NUMBER	258804	
CLASS	15-05	
1)VIDEOCON INDUSTRIES LIMITED. A COMPANY INCORPORATED UNDER THE INDIAN COMPANIES ACT, AT 14 KMS. STONE, AURANGABAD-PAITHAN ROAD, CHITEGAON, TQ.PAITHAN, DIST. AURANGABAD-431105, MAHARASHTRA, INDIA.		
DATE OF REGISTRATION	17/12/2013	
TITLE	WASHING MACHINE	
PRIORITY NA		
DESIGN NUMBER	257400	
CLASS	12-16	
1)VOLVO LASTVAGNAR AB, OF SE 405 08 GÖTEBORG, SWEDEN.		
DATE OF REGISTRATION	10/10/2013	
TITLE	TRIM PANEL FOR VEHICLES	
PRIORITY		
PRIORITY NUMBER	DATE	COUNTRY
2013/0151	11/04/2013	SWEDEN
DESIGN NUMBER	259398	
CLASS	09-03	
1)COLGATE-PALMOLIVE COMPANY, A DELAWARE CORPORATION, 300 PARK AVENUE, NEW YORK, NEW YORK 10022, UNITED STATES OF AMERICA		
DATE OF REGISTRATION	15/01/2014	
TITLE	ORAL CARE IMPLEMENT PACKAGE	
PRIORITY		
PRIORITY NUMBER	DATE	COUNTRY
29/462,730	07/08/2013	U.S.A.



DESIGN NUMBER	259533		
CLASS	05-05		
1)SATHEESAN V C/O AVID APPAREL INDUSTRIES, B-17, SECTOR-58 NOIDA-201301 (UP) INDIA, INDIAN			
DATE OF REGISTRATION	20/01/2014		
TITLE	TEXTILE FABRIC		
PRIORITY NA			
DESIGN NUMBER	259350		
CLASS	28-03		
1)KONINKLIJKE PHILIPS N.V., A COMPANY ORGANIZED AND EXISTING UNDER THE LAWS OF THE KINGDOM OF THE NETHERLANDS, RESIDING AT EINDHOVEN, WHOSE POST-OFFICE ADDRESS IS HIGH TECH CAMPUS 5, 5656 AE EINDHOVEN, THE NETHERLANDS			
DATE OF REGISTRATION	10/01/2014		
TITLE	SKIN REJUVENATION APPARATUS		
PRIORITY			
PRIORITY NUMBER	DATE	COUNTRY	
002280313-0004	24/07/2013	OHIM	
DESIGN NUMBER	259728		
CLASS	12-16		
1)FORD GLOBAL TECHNOLOGIES, LLC A COMPANY ORGANIZED AND EXISTING UNDER THE LAWS OF UNITED STATES OF AMERICA, HAVING ITS OFFICE AT 330 TOWN CENTER DRIVE, SUITE 800, DEARBORN MICHIGAN-48126, UNITED STATES OF AMERICA			
DATE OF REGISTRATION	27/01/2014		
TITLE	VEHICLE HOOD		
PRIORITY			
PRIORITY NUMBER	DATE	COUNTRY	
201330380415.2	09/08/2013	CHINA	
			

DESIGN NUMBER	258806		
CLASS	07-04		
1)ZEB A INDUSTRIES IS A PROPRIETORSHIP FIRM OF 10, KHOJA SOCIETY, NR. VED MANDIR, KANKARIA, AHMEDABAD-22, GUJARAT, INDIA.			
DATE OF REGISTRATION	17/12/2013		
TITLE	WATER STRAINER		
PRIORITY NA			
DESIGN NUMBER	258118		
CLASS	19-06		
1)NIYATI ENTERPRISE., (AN INDIAN SOLE PROPRIETORSHIP CONCERN), HAVING OFFICE AT 223/224, RAJ RATNA INDUSTRIAL ESTATE, 2ND FLOOR, OPP. S. N. D. T. COLLEGE, MALAD (WEST), MUMBAI-400064, MAHARASHTRA, INDIA. WHOSE PROPRIETOR IS DINESH KHAKHAR. (INDIAN NATIONAL) OF ABOVE ADDRESS			
DATE OF REGISTRATION	13/11/2013		
TITLE	PEN		
PRIORITY NA			
DESIGN NUMBER	259774		
CLASS	12-16		
1)FORD GLOBAL TECHNOLOGIES, LLC A COMPANY ORGANIZED AND EXISTING UNDER THE LAWS OF UNITED STATES OF AMERICA, HAVING ITS OFFICE AT 330 TOWN CENTER DRIVE, SUITE 800, DEARBORN MICHIGAN-48126, UNITED STATES OF AMERICA			
DATE OF REGISTRATION	28/01/2014		
TITLE	VEHICLE REAR LOWER BUMPER COVER		
PRIORITY			
PRIORITY NUMBER	DATE	COUNTRY	
201330380715.0	09/08/2013	CHINA	

DESIGN NUMBER	257525	
CLASS	14-02	
1)HOMAG HOLZBEARBEITUNGSSYSTEME GMBH, HOMAGSTRASSE 3-5, 72296 SCHOPFLOCH, GERMANY		
DATE OF REGISTRATION	15/10/2013	
TITLE	INFORMATION RETRIEVAL EQUIPMENT	
PRIORITY		
PRIORITY NUMBER	DATE	COUNTRY
002221218-0001	16/04/2013	OHIM

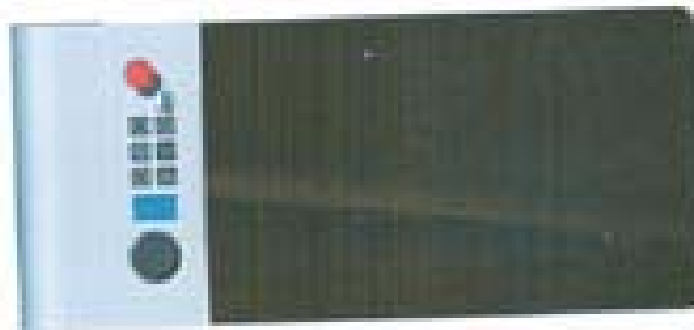

DESIGN NUMBER	257963	
CLASS	07-02	
1)LENOX CORPORATION, 1414 RADCLIFFE STREET, BISTOL, PA 19007, UNITED STATES OF AMERICA, NATIONALITY: UNITED STATES OF AMERICA		
DATE OF REGISTRATION	04/11/2013	
TITLE	SERVING VESSEL	
PRIORITY		
PRIORITY NUMBER	DATE	COUNTRY
29/453,789	02/05/2013	U.S.A.

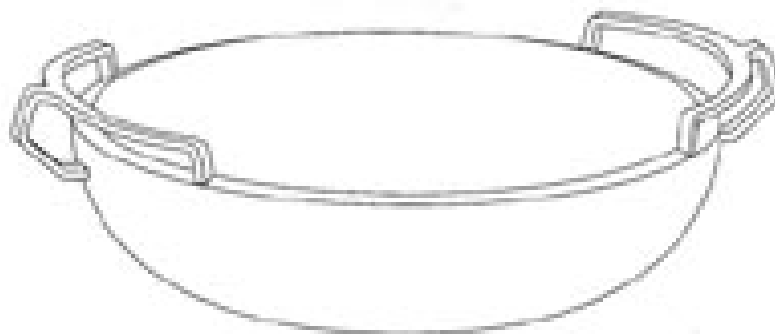

DESIGN NUMBER	258115	
CLASS	19-06	
1)NIYATI ENTERPRISE., (AN INDIAN SOLE PROPRIETORSHIP CONCERN), HAVING OFFICE AT 223/224, RAJ RATNA INDUSTRIAL ESTATE, 2ND FLOOR, OPP. S. N. D. T. COLLEGE, MALAD (WEST), MUMBAI-400064, MAHARASHTRA, INDIA. WHOSE PROPRIETOR IS DINESH KHAKHAR. (INDIAN NATIONAL) OF ABOVE ADDRESS		
DATE OF REGISTRATION	13/11/2013	
TITLE	PEN	
PRIORITY NA		

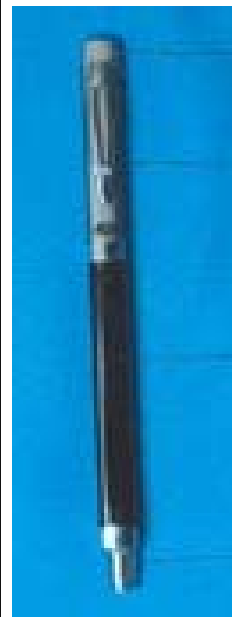

DESIGN NUMBER	259772	
CLASS	12-16	
1)FORD GLOBAL TECHNOLOGIES, LLC A COMPANY ORGANIZED AND EXISTING UNDER THE LAWS OF UNITED STATES OF AMERICA, HAVING ITS OFFICE AT 330 TOWN CENTER DRIVE, SUITE 800, DEARBORN MICHIGAN-48126, UNITED STATES OF AMERICA		
DATE OF REGISTRATION	28/01/2014	
TITLE	VEHICLE FRONT UPPER GRILLE	
PRIORITY		
PRIORITY NUMBER	DATE	COUNTRY
201330380797.9	09/08/2013	CHINA

