

**INTRODUCTION**

In view of the recent amendment made in the Designs (Amendment) Rules, 2008 with effect from 17/06/2008, Publication of the matter relating to Designs is being published in the Official Journal of The Patent Office. This Journal is being published on weekly basis on every Friday covering the various proceedings on Designs as required according to the provisions of under Rule 22, 25, 27 and 39 of the Design (Amendment) Rules, 2008. All the enquiries on this Official Journal and other information as required by the public should be addressed to the Controller General of Patents, Designs & Trade Marks. Suggestions and comments are requested from all quarters so that the content can be enriched.

## COPYRIGHT PUBLICATION

SL NO	REGISTERED DESIGN NUMBERS	RENEWED ON
1.	182805	26.06.2014
2.	184239	25.06.2014
3.	187043	26.06.2014
4.	189207	25.06.2014
5.	190305	25.06.2014
6.	190913	25.06.2014
7.	190914	25.06.2014
8.	196337	25.07.2014
9.	196338	25.07.2014
10.	196782	30.07.2014
11.	196783	30.07.2014
12.	196784	30.07.2014
13.	196963	15.07.2014
14.	196964	15.07.2014
15.	196965	15.07.2014
16.	196966	15.07.2014
17.	197427	25.07.2014
18.	197428	25.07.2014
19.	198066	25.07.2014
20.	198069	25.07.2014
21.	200012	25.07.2014
22.	200016	25.07.2014
23.	200017	25.07.2014
24.	200019	25.07.2014
25.	200020	25.07.2014
26.	201114	05.06.2014
27.	247135	28.07.2014
28.	247603	28.07.2014
29.	247606	28.07.2014
30.	247963	28.07.2014
31.	247964	28.07.2014
32.	247965	15.07.2014
33.	247966	15.07.2014
34.	248389	30.07.2014
35.	248845	28.07.2014
36.	248846	15.07.2014
37.	248847	15.07.2014
38.	249248	15.07.2014
39.	249249	15.07.2014
40.	249408	28.07.2014
41.	249706	28.07.2014

**THE DESIGNS ACT 2000**  
**SECTION 30**  
**DESIGN ASSIGNMENT**

The Design stands in the name of **SARA LEE HOUSEHOLD AND BODY CARE NEDERLAND B.V.** registered under the Designs Act, 2000 has been assigned in the Register of Designs in the name as follows:-

<b>Design No.</b>	<b>Class</b>	<b>Name</b>
<b>225698</b>	<b>23-04</b>	<b>SARA LEE HOUSEHOLD CARE NEDERLAND B.V OF, VLEUTENSEVAART 100, 3532 AD UTRECHT, THE NETHERLANDS, A DUTCH COMPANY</b>

**RESTORATION OF LAPSED DESIGNS  
UNDER SECTION 12 (2) OF THE DESIGNS ACT, 2000**

**(01)**

An application made under Section 12 (2) of the Designs act, 2000 on **27.11.2013**, for Restoration of **Design No.190914 dated 07.01.2003** in the name of **EFFIPRESS ENGINEERING PVT. LTD., A COMPANY INCORPORATED UNDER THE INDIAN COMPANIES ACT, AT 148-F, ST. CRYIL'S ROAD, BANDRA, MUMBAI-400050, MAHARASHTRA, INDIA** has been allowed.

**(02)**

An application made under Section 12 (2) of the Designs act, 2000 on **27.11.2013**, for Restoration of **Design No.190913 dated 07.01.2003** in the name of **EFFIPRESS ENGINEERING PVT. LTD., A COMPANY INCORPORATED UNDER THE INDIAN COMPANIES ACT, AT 148-F, ST. CRYIL'S ROAD, BANDRA, MUMBAI-400050, MAHARASHTRA, INDIA** has been allowed.

**(03)**

An application made under Section 12 (2) of the Designs act, 2000 on **19.08.2013**, for Restoration of **Design No.190305 dated 29.10.2002** in the name of **TAPARIA TOOLS LIMITED, A COMPANY INCORPORATED UNDER THE INDIAN COMPANIES ACT, AT 423-424/A-2 SHAH & NAHAR, LOWER PAREL (W), MUMBAI:-400013, MAHARASHTRA, INDIA** has been allowed.

**(04)**

An application made under Section 12 (2) of the Designs act, 2000 on **05.02.2013**, for Restoration of **Design No.189207 dated 01.03.2002** in the name of **AMERICAN TOOL COMPANIES, INC., A CORPORATION ORGANIZED AND EXISTING UNDER THE LAWS OF THE STATE OF DELAWARE WITH A PLACE OF BUSINESS AT 2800 W. HIGGINS ROAD, SUITE 805, HOFFMAN ESTATE, ILLINOIS, UNITED STATES OF AMERICA** has been allowed.

**(05)**

An application made under Section 12 (2) of the Designs act, 2000 on **04.08.2011**, for Restoration of **Design No.184239 dated 26.12.2000** in the name of **GODREJ SARA LEE LIMITED, A COMPANY INCORPORATED UNDER THE COMPANIES ACT, 1956 OF PIROJSHANAGAR, EASTERN EXPRESS HIGHWAY, VIKHROLI, MUMBAI-400079, MAHARASHTRA, INDIA** has been allowed.

## REGISTRATION OF DESIGNS

The following designs have been registered. They are now open for public inspection. In the following each entry the Date of Registration is shown. The Priority Number, Priority Date and Priority Country are also shown

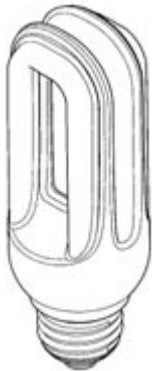
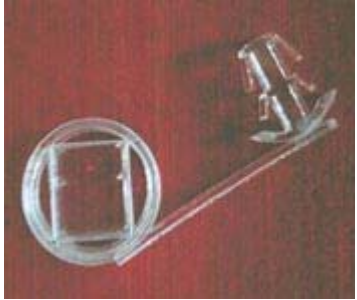
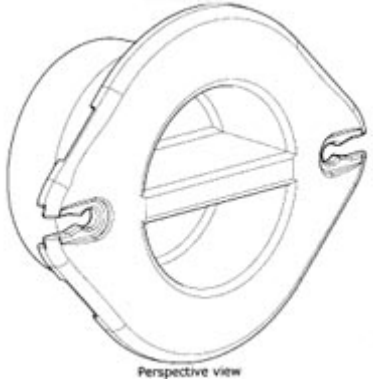
<b>DESIGN NUMBER</b>	258600		
<b>CLASS</b>	26-04		
<b>1)KONINKLIJKE PHILIPS N.V., A COMPANY ORGANIZED AND EXISTING UNDER THE LAWS OF THE KINGDOM OF THE NETHERLANDS, RESIDING AT EINDHOVEN,</b> WHOSE POST-OFFICE ADDRESS IS HIGH TECH CAMPUS 5, 5656 AE EINDHOVEN, THE NETHERLANDS			
<b>DATE OF REGISTRATION</b>	06/12/2013		
<b>TITLE</b>	LED BULB		
<b>PRIORITY</b>			
<b>PRIORITY NUMBER</b>	<b>DATE</b>	<b>COUNTRY</b>	
002282426-0008	26/07/2013	OHIM	
<b>DESIGN NUMBER</b>	258943		
<b>CLASS</b>	08-07		
<b>1)MR. SHAILENDRA PATNI, INDIAN NATIONAL OF</b> C/202, YAMNOTRI, MAHAVIR NAGAR, DHANUKARWADI, MAHARSHTRA, MUMBAI-400067			
<b>DATE OF REGISTRATION</b>	24/12/2013		
<b>TITLE</b>	SEAL		
<b>PRIORITY NA</b>			
<b>DESIGN NUMBER</b>	257389		 <p style="text-align: center; font-size: small;">Perspective view</p>
<b>CLASS</b>	15-99		
<b>1)SANDVIK INTELLECTUAL PROPERTY AB OF</b> SE-811 81 SANDVIKEN, SWEDEN, A SWEDISH COMPANY			
<b>DATE OF REGISTRATION</b>	10/10/2013		
<b>TITLE</b>	CRUSHER		
<b>PRIORITY</b>			
<b>PRIORITY NUMBER</b>	<b>DATE</b>	<b>COUNTRY</b>	
001368807	22/04/2013	OHIM	

<b>DESIGN NUMBER</b>	257238	
<b>CLASS</b>	23-03	
<b>1)SUPERNOVA TECHNOLOGIES PVT. LTD A COMPANY REGISTERED UNDER COMPANY ACT 1956 OF I/103, PHASE-4, ZONE B-9, G.I.D.C ESTATE, VITTHAL UDYOG NAGAR-388121. GUJARAT. INDIA</b>		
<b>DATE OF REGISTRATION</b>	08/10/2013	
<b>TITLE</b>	FIRE PLACE	
<b>PRIORITY NA</b>		

<b>DESIGN NUMBER</b>	258597	
<b>CLASS</b>	26-04	
<b>1)KONINKLIJKE PHILIPS N.V., A COMPANY ORGANIZED AND EXISTING UNDER THE LAWS OF THE KINGDOM OF THE NETHERLANDS, RESIDING AT EINDHOVEN, WHOSE POST-OFFICE ADDRESS IS HIGH TECH CAMPUS 5, 5656 AE EINDHOVEN, THE NETHERLANDS</b>		
<b>DATE OF REGISTRATION</b>	06/12/2013	
<b>TITLE</b>	LED BULB	
<b>PRIORITY</b>		
<b>PRIORITY NUMBER</b>	<b>DATE</b>	<b>COUNTRY</b>
002282392-0006	26/07/2013	OHIM

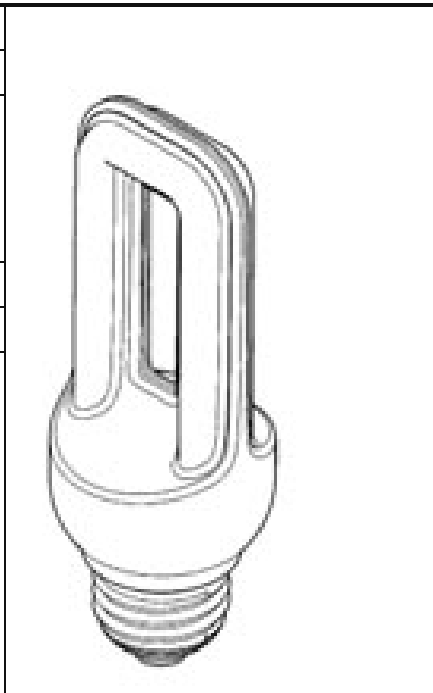

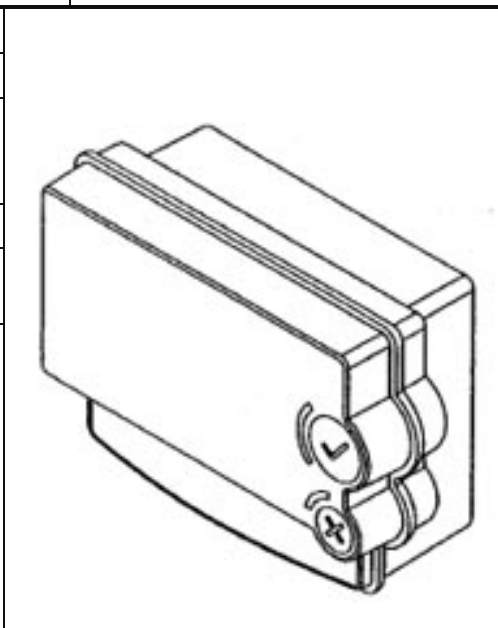

<b>DESIGN NUMBER</b>	253791	
<b>CLASS</b>	13-03	
<b>1)CROWN EQUIPMENT CORPORATION, A CORPORATION OF OHIO OF 40 SOUTH WASHINGTON STREET, NEW BREMEN, OHIO 45869, UNITED STATES</b>		
<b>DATE OF REGISTRATION</b>	13/05/2013	
<b>TITLE</b>	CONTROL APPARATUS FOR A FLEET MANAGEMENT SYSTEM	
<b>PRIORITY</b>		
<b>PRIORITY NUMBER</b>	<b>DATE</b>	<b>COUNTRY</b>
29/437,154	14/11/2012	U.S.A.

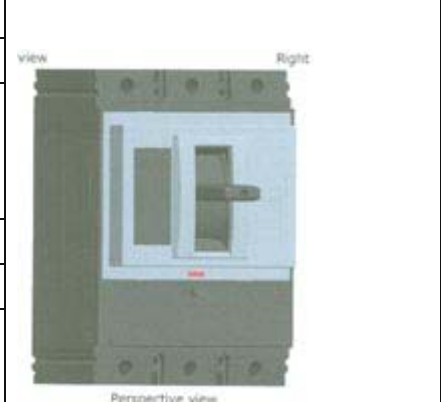

<b>DESIGN NUMBER</b>	259231	
<b>CLASS</b>	15-02	
<b>1)CROMPTON GREAVES LIMITED,</b> CG HOUSE, 6TH FLOOR, DR. ANNIE BESANT ROAD, WORLI, MUMBAI - 400030, MAHARASHTRA, INDIA; AN INDIAN COMPANY		
<b>DATE OF REGISTRATION</b>	03/01/2014	
<b>TITLE</b>	PUMP	
<b>PRIORITY NA</b>		

<b>DESIGN NUMBER</b>	257388	
<b>CLASS</b>	13-03	
<b>1)LARSEN &amp; TOUBRO LIMITED, AN INDIAN COMPANY INCORPORATED</b> <b>UNDER THE COMPANIES ACT, 1956 OF</b> L & T HOUSE, BALLARD ESTATE, MUMBAI 400001, STATE OF MAHARASHTRA, INDIA		
<b>DATE OF REGISTRATION</b>	10/10/2013	
<b>TITLE</b>	MOULDED CASE CIRCUIT BREAKER	
<b>PRIORITY NA</b>		

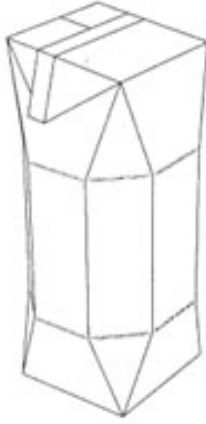
<b>DESIGN NUMBER</b>	256854		
<b>CLASS</b>	12-08		
<b>1)HONDA MOTOR CO., LTD., A JAPANESE</b> <b>CORPORATION, OF</b> 1-1, MINAMI-AOYAMA 2-CHOME, MINATO-KU, TOKYO, 107-8556, JAPAN			
<b>DATE OF</b> <b>REGISTRATION</b>	27/09/2013		
<b>TITLE</b>	AUTOMOBILE		
<b>PRIORITY</b>			
<b>PRIORITY NUMBER</b>	<b>DATE</b>		<b>COUNTRY</b>
2013-007612	04/04/2013		JAPAN

<b>DESIGN NUMBER</b>	258567		
<b>CLASS</b>	09-03		
<b>1)TETRA LAVAL HOLDINGS &amp; FINANCE S.A., OF AVENUE GÉNÉRAL-GUISAN 70, CH-1009 PULLY, 1009 SWITZERLAND</b>			
<b>DATE OF REGISTRATION</b>	05/12/2013		
<b>TITLE</b>	PACKAGING		
<b>PRIORITY</b>			
<b>PRIORITY NUMBER</b>	<b>DATE</b>	<b>COUNTRY</b>	
002282137-0007	26/07/2013	OHIM	
<b>DESIGN NUMBER</b>	255215		
<b>CLASS</b>	13-03		
<b>1)LARSEN &amp; TOUBRO LIMITED, L&amp;T HOUSE, BALLARD ESTATE, P.O. BOX: 278, MUMBAI 400 001, MAHARASHTRA, INDIA</b> AN INDIAN COMPANY REGISTERED UNDER THE PROVISIONS OF THE COMPANIES ACT 1956			
<b>DATE OF REGISTRATION</b>	15/07/2013		
<b>TITLE</b>	MOULDED CASE CIRCUIT BREAKER		
<b>PRIORITY NA</b>			
<b>DESIGN NUMBER</b>	258568		
<b>CLASS</b>	09-03		
<b>1)TETRA LAVAL HOLDINGS &amp; FINANCE S.A., OF AVENUE GÉNÉRAL-GUISAN 70, CH-1009 PULLY, 1009 SWITZERLAND</b>			
<b>DATE OF REGISTRATION</b>	05/12/2013		
<b>TITLE</b>	PACKAGING		
<b>PRIORITY</b>			
<b>PRIORITY NUMBER</b>	<b>DATE</b>	<b>COUNTRY</b>	
002282137-0008	26/07/2013	OHIM	



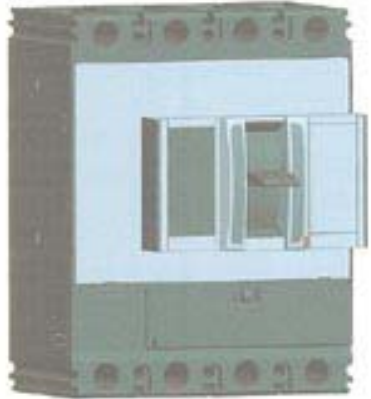
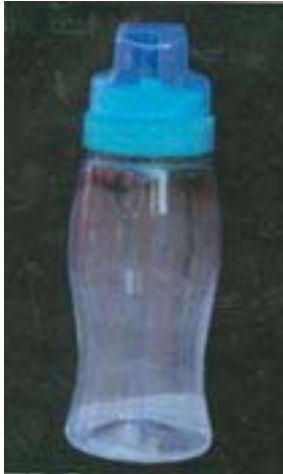

<b>DESIGN NUMBER</b>	259856	
<b>CLASS</b>	06-01	
<b>1) NATIONAL PLASTO PRODUCTS PRIVATE LIMITED, AN INDIAN COMPANY HAVING ITS REGISTERED OFFICE AT 19, SUKEAS LANE, 1ST FLOOR, KOLKATA 700001, WEST BENGAL, INDIA</b>		
<b>DATE OF REGISTRATION</b>	30/01/2014	
<b>TITLE</b>	CHAIR	
<b>PRIORITY NA</b>		
<b>DESIGN NUMBER</b>	255216	
<b>CLASS</b>	13-03	
<b>1) LARSEN &amp; TOUBRO LIMITED, L&amp;T HOUSE, BALLARD ESTATE, P.O. BOX: 278, MUMBAI 400 001, MAHARASHTRA, INDIA</b> AN INDIAN COMPANY REGISTERED UNDER THE PROVISIONS OF THE COMPANIES ACT 1956		
<b>DATE OF REGISTRATION</b>	15/07/2013	
<b>TITLE</b>	MOULDED CASE CIRCUIT BREAKER	
<b>PRIORITY NA</b>		
<b>DESIGN NUMBER</b>	259638	
<b>CLASS</b>	09-01	
<b>1) V. B. INDUSTRIES, PLOT NO. 64/65/66, DAMAN INDUSTRIAL ESTATE, NEAR FIRE STATION, SOMNATH ROAD, DAMAN 396210, (U.T.), INDIA, A PARTNERSHIP FIRM REGISTERED UNDER THE INDIAN PARTNERSHIP ACT, WHOSE PARTNERS ARE (1) BHAWARLAL MANGILAL JAIN, (2) PRAVIN BHAWARLAL JAIN (3) NARESH BHAWARLAL JAIN, ALL OF INDIAN NATIONALITY, RESIDENT OF 92/2, JAWAHAR NAGAR, ROAD NO. 5, GOREGAON WEST, MUMBAI 400062, MAHARASHTRA, INDIA</b>		
<b>DATE OF REGISTRATION</b>	24/01/2014	
<b>TITLE</b>	BOTTLE WITH CAP	
<b>PRIORITY NA</b>		

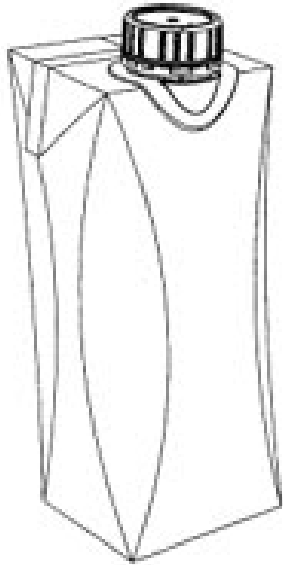
<b>DESIGN NUMBER</b>	257353	
<b>CLASS</b>	07-01	
<b>1)RAVISSANT PRIVATE LIMITED, AN INDIAN COMPANY, OF 50-51, COMMERCIAL COMPLEX, NEW FRIENDS COLONY, NEW DELHI- 110065, INDIA</b>		
<b>DATE OF REGISTRATION</b>	09/10/2013	
<b>TITLE</b>	COFFEE POT	
<b>PRIORITY NA</b>		

<b>DESIGN NUMBER</b>	258570	
<b>CLASS</b>	09-03	
<b>1)TETRA LAVAL HOLDINGS &amp; FINANCE S.A., OF AVENUE GÉNÉRAL-GUISAN 70, CH-1009 PULLY, 1009 SWITZERLAND</b>		
<b>DATE OF REGISTRATION</b>	05/12/2013	
<b>TITLE</b>	PACKAGING	
<b>PRIORITY</b>		
<b>PRIORITY NUMBER</b>	<b>DATE</b>	<b>COUNTRY</b>
002282137-0010	26/07/2013	OHIM

<b>DESIGN NUMBER</b>	259185	
<b>CLASS</b>	23-01	
<b>1)EASOL PRIVATE LIMITED AN INDIAN COMPANY ESTABLISHED UNDER THE COMPANY'S ACT, 1956 AND WHOSE ADDRESS IS S. NO. 228, OPP. SHIVANE GRAMPANCHAYAT, AT POST SHIVANE, TALUKA-HAVELI, PUNE:411023, MAHARASHTRA, INDIA</b>		
<b>DATE OF REGISTRATION</b>	03/01/2014	
<b>TITLE</b>	WATER DISINFECTANT CARTRIDGE	
<b>PRIORITY NA</b>		

<b>DESIGN NUMBER</b>	255231		
<b>CLASS</b>	15-99		
<b>1)DANIELI &amp; C. OFFICINE MECCANICHE S.P.A., AN ITALIAN COMPANY, OF VIA NAZIONALE, 41, 33042 BUTTRIO (UD), ITALY</b>			
<b>DATE OF REGISTRATION</b>	15/07/2013		
<b>TITLE</b>	SLITTING GUIDES FOR ROLLING MILLS		
<b>PRIORITY NA</b>			
<b>DESIGN NUMBER</b>	257355		
<b>CLASS</b>	07-01		
<b>1)RAVISSANT PRIVATE LIMITED, AN INDIAN COMPANY, OF 50-51, COMMERCIAL COMPLEX, NEW FRIENDS COLONY, NEW DELHI-110065, INDIA</b>			
<b>DATE OF REGISTRATION</b>	09/10/2013		
<b>TITLE</b>	POT		
<b>PRIORITY NA</b>			
<b>DESIGN NUMBER</b>	245565		
<b>CLASS</b>	07-02		
<b>1)SOCIÉTÉ DES PRODUITS NESTLÉ S.A. A COMPANY INCORPORATED UNDER THE LAWS OF THE SWITZERLAND HAVING ITS REGISTERED OFFICE AT 1800 VEVEY, SWITZERLAND</b>			
<b>DATE OF REGISTRATION</b>	24/05/2012		
<b>TITLE</b>	COFFEE MACHINE		
<b>PRIORITY</b>			
<b>PRIORITY NUMBER</b>	<b>DATE</b>	<b>COUNTRY</b>	
138617	24/02/2012	SWITZERLAND	

<b>DESIGN NUMBER</b>	257996		
<b>CLASS</b>	12-16		
<b>1)MAN TRUCK &amp; BUS AG, A GERMAN COMPANY OF DACHAUER STRASSE 667, 80995 MÜNCHEN, GERMANY</b>			
<b>DATE OF REGISTRATION</b>	06/11/2013		
<b>TITLE</b>	LEFT BUMPER FOR VEHICLES		
<b>PRIORITY NA</b>			
<b>DESIGN NUMBER</b>	258572		
<b>CLASS</b>	09-03		
<b>1)TETRA LAVAL HOLDINGS &amp; FINANCE S.A., OF AVENUE GÉNÉRAL-GUISAN 70, CH-1009 PULLY, 1009 SWITZERLAND</b>			
<b>DATE OF REGISTRATION</b>	05/12/2013		
<b>TITLE</b>	PACKAGING		
<b>PRIORITY</b>			
<b>PRIORITY NUMBER</b>	<b>DATE</b>	<b>COUNTRY</b>	
002282137-0012	26/07/2013	OHIM	
<b>DESIGN NUMBER</b>	258679		
<b>CLASS</b>	08-07		
<b>1)MR. SHAILENDRA PATNI, INDIAN NATIONAL OF C/202, YAMNOTRI, MAHAVIR NAGAR, DHANUKARWADI, MAHARSHTRA, MUMBAI-400067</b>			
<b>DATE OF REGISTRATION</b>	12/12/2013		
<b>TITLE</b>	SEAL		
<b>PRIORITY NA</b>			

<b>DESIGN NUMBER</b>	258748	
<b>CLASS</b>	23-04	
<b>1)OMNISCIENT TREATMENT TECHNOLOGIES PRIVATE LIMITED, A COMPANY INCORPORATED UNDER THE LAWS OF INDIA, 902, GROUND FLOOR, KHARE TOWN, DHARAMPETH, NAGPUR-440010, MAHARASHTRA, INDIA</b>		
<b>DATE OF REGISTRATION</b>	16/12/2013	
<b>TITLE</b>	OZONE GENERATOR	
<b>PRIORITY NA</b>		

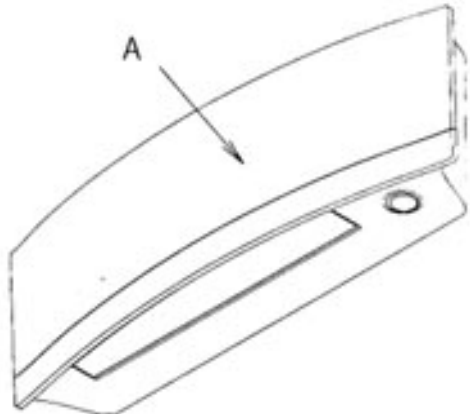
<b>DESIGN NUMBER</b>	259187	
<b>CLASS</b>	23-04	
<b>1)DAIKIN INDUSTRIES LTD. A JAPANESE COMPANY OF THE ADDRESS: UMEDA CENTER BUILDING, 4-12 NAKAZAKI-NISHI 2-CHOME, KITA-KU, OSAKA-SHI, OSAKA-FU, JAPAN</b>		
<b>DATE OF REGISTRATION</b>	03/01/2014	
<b>TITLE</b>	AIR CONDITIONER	
<b>PRIORITY</b>		
<b>PRIORITY NUMBER</b>	<b>DATE</b>	<b>COUNTRY</b>
JP2013-017390	30/07/2013	JAPAN

<b>DESIGN NUMBER</b>	259577	
<b>CLASS</b>	05-05	
<b>1)PARRY MURRAY &amp; CO. LTD., COMPANY REGISTERED UNDER THE LAWS OF ENGLAND AND WALES, HAVING ITS PRINCIPAL PLACE OF BUSINESS AT 3RD FLOOR, SIMPSON HOUSE, 6 CHERRY ORCHARD ROAD, CROYDON, CRO 6BA, UNITED KINGDOM</b>		
<b>DATE OF REGISTRATION</b>	22/01/2014	
<b>TITLE</b>	TEXTILE FABRIC	
<b>PRIORITY NA</b>		

<b>DESIGN NUMBER</b>	257357	
<b>CLASS</b>	07-01	
<b>1)RAVISSANT PRIVATE LIMITED, AN INDIAN COMPANY, OF</b> 50-51, COMMERCIAL COMPLEX, NEW FRIENDS COLONY, NEW DELHI-110065, INDIA		
<b>DATE OF REGISTRATION</b>	09/10/2013	
<b>TITLE</b>	WINE BUCKET	
<b>PRIORITY NA</b>		

<b>DESIGN NUMBER</b>	257935	
<b>CLASS</b>	21-01	
<b>1)DR. ING. H.C.F. PORSCHE AKTIENGESELLSCHAFT, A GERMAN COMPANY OF</b> PORSCHPLATZ 1, 70435 STUTTGART, GERMANY		
<b>DATE OF REGISTRATION</b>	01/11/2013	
<b>TITLE</b>	TOY CAR	
<b>PRIORITY NA</b>		

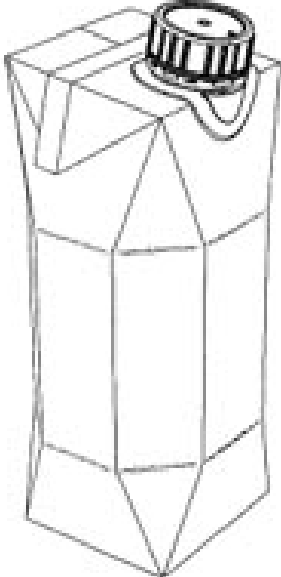
<b>DESIGN NUMBER</b>	258569		
<b>CLASS</b>	09-03		
<b>1)TETRA LAVAL HOLDINGS &amp; FINANCE S.A.,</b> OF AVENUE GÉNÉRAL-GUISAN 70, CH-1009 PULLY, SWITZERLAND			
<b>DATE OF REGISTRATION</b>	05/12/2013		
<b>TITLE</b>	PACKAGING		
<b>PRIORITY</b>			
<b>PRIORITY NUMBER</b>	<b>DATE</b>	<b>COUNTRY</b>	
002282137-0009	26/07/2013	OHIM	

<b>DESIGN NUMBER</b>	259862	
<b>CLASS</b>	06-01	
<b>1) NATIONAL PLASTO PRODUCTS PRIVATE LIMITED, AN INDIAN COMPANY HAVING ITS REGISTERED OFFICE AT 19, SUKEAS LANE, 1ST FLOOR, KOLKATA 700 001, WEST BENGAL, INDIA</b>		
<b>DATE OF REGISTRATION</b>	30/01/2014	
<b>TITLE</b>	CHAIR	
<b>PRIORITY NA</b>		
<b>DESIGN NUMBER</b>	255217	
<b>CLASS</b>	13-03	
<b>1) LARSEN &amp; TOUBRO LIMITED, L&amp;T HOUSE, BALLARD ESTATE, P.O. BOX: 278, MUMBAI 400 001, MAHARASHTRA, INDIA AN INDIAN COMPANY REGISTERED UNDER THE PROVISIONS OF THE COMPANIES ACT 1956</b>		
<b>DATE OF REGISTRATION</b>	15/07/2013	
<b>TITLE</b>	MOULDED CASE CIRCUIT BREAKER	
<b>PRIORITY NA</b>		
<b>DESIGN NUMBER</b>	254762	
<b>CLASS</b>	11-01	
<b>1) H. K JEWELS PVT. LTD. A COMPANY REGISTERED UNDER COMPANY ACT 1956 OF 1701-A, 17TH FLOOR, THE CAPITAL BUILDING, B-WING, OPP ICICI BANK, BANDRA KURLA COMPLEX, BANDRA (E), MUMBAI-400051, INDIA</b>		
<b>DATE OF REGISTRATION</b>	25/06/2013	
<b>TITLE</b>	EARRING	
<b>PRIORITY NA</b>		

<b>DESIGN NUMBER</b>	256510		
<b>CLASS</b>	15-07		
<b>1)BSH BOSCH UND SIEMENS HAUSGERÄTE GMBH, OF CARL-WERY - STR.34, 81739, MUNICH, GERMANY, A GERMAN COMPANY</b>			
<b>DATE OF REGISTRATION</b>	16/09/2013		
<b>TITLE</b>	REFRIGERATOR		
<b>PRIORITY NA</b>			
<b>DESIGN NUMBER</b>	258805		
<b>CLASS</b>	15-05		
<b>1)VIDEOCON INDUSTRIES LIMITED. A COMPANY INCORPORATED UNDER THE INDIAN COMPANIES ACT, AT 14 KMS. STONE, AURANGABAD-PAITHAN ROAD, CHITEGAON, TQ.PAITHAN, DIST. AURANGABAD-431105, MAHARASHTRA, INDIA</b>			
<b>DATE OF REGISTRATION</b>	17/12/2013		
<b>TITLE</b>	TUB FOR WASHING MACHINE		
<b>PRIORITY NA</b>			
<b>DESIGN NUMBER</b>	249773		
<b>CLASS</b>	14-03		
<b>1)APPLE INC., 1 INFINITE LOOP, CUPERTINO, CALIFORNIA 95014, UNITED STATES OF AMERICA, A CORPORATION INCORPORATED IN THE STATE OF CALIFORNIA</b>			
<b>DATE OF REGISTRATION</b>	29/11/2012		
<b>TITLE</b>	MOBILE PHONE		
<b>PRIORITY</b>			
<b>PRIORITY NUMBER</b>	<b>DATE</b>	<b>COUNTRY</b>	
29/423,180	29/05/2012	U.S.A.	

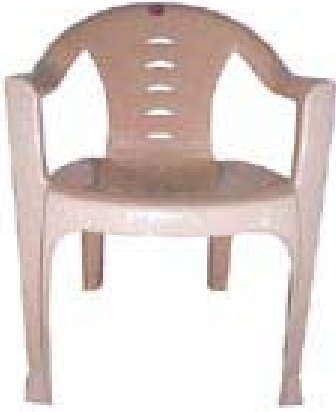
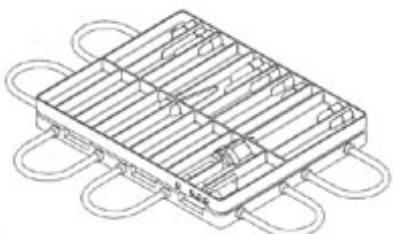
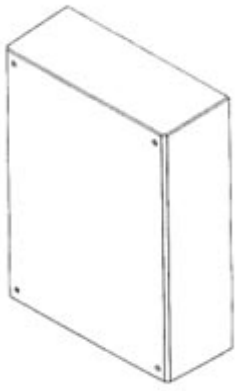

<b>DESIGN NUMBER</b>	256847		
<b>CLASS</b>	06-01		
<b>1)WIM PLAST LIMITED, A PUBLIC LIMITED COMPANY REGISTERED UNDER THE PROVISION OF INDIAN COMPANIES ACT, 1956, HAVING OFFICE ADDRESS AT</b> 5 CORPORATE AVENUE, 'B' WING, CELLO HOUSE, SONAWALA ROAD, GOREGAON (EAST), MUMBAI-400 063, MAHARASHTRA, INDIA			
<b>DATE OF REGISTRATION</b>	26/09/2013		
<b>TITLE</b>	CHAIR		
<b>PRIORITY NA</b>			
<b>DESIGN NUMBER</b>	258636		
<b>CLASS</b>	24-01		
<b>1)FENWAL, INC., THREE CORPORATE DRIVE, LAKE ZURICH, ILLINOIS 60047, UNITED STATES OF AMERICA</b>			
<b>DATE OF REGISTRATION</b>	09/12/2013		
<b>TITLE</b>	CASSETTE ASSEMBLY WITH PUMP TUBING FOR APHERESIS COLLECTION SYSTEMS		
<b>PRIORITY</b>			
<b>PRIORITY NUMBER</b>	<b>DATE</b>	<b>COUNTRY</b>	
29/472,722	15/11/2013	U.S.A.	
<b>DESIGN NUMBER</b>	258803		
<b>CLASS</b>	13-03		
<b>1)FIBOX OY AB, A COMPANY OF FINLAND OF KEILARANTA 19, FI-02150 ESPOO, FINLAND</b>			
<b>DATE OF REGISTRATION</b>	17/12/2013		
<b>TITLE</b>	CASING FOR ELECTRICAL DEVICE		
<b>PRIORITY</b>			
<b>PRIORITY NUMBER</b>	<b>DATE</b>	<b>COUNTRY</b>	
001377253-0003	27/06/2013	OHIM	

<b>DESIGN NUMBER</b>	258945	
<b>CLASS</b>	02-04	
<b>1)BUNNY POLY PLAST (INDIA) (AN INDIAN PARTNERSHIP CONCERN) AT C-16, SITE A, SIKANDRA INDUSTRIAL AREA, AGRA (U.P.) INDIA, WHOSE PARTNRS ARE VIJAY KUMAR VIJ, SMT. RITA VIJ &amp; ROHIT VIJ, ALL ARE INDIANS, R/O 46, BHARATPUR HOUSE, AGRA (U.P.) INDIA, OF THE ABOVE ADDRESS</b>		
<b>DATE OF REGISTRATION</b>	24/12/2013	
<b>TITLE</b>	SOLE OF FOOTWEAR	
<b>PRIORITY NA</b>		

<b>DESIGN NUMBER</b>	259235	
<b>CLASS</b>	08-07	
<b>1)(1) RUPESHBHAI MANSUKHBHAI MANSARA (2) JAYESHBHAI GOBARBHAI SHEKHALIYA (3) CHETANBHAI LAVJIBHAI SINGHALA (ALL THE PARTNERS ARE ADULT &amp; INDIAN NATIONAL) PARTNERS OF JAY SOMNATH METAL (INDIAN PARTNERSHIP FIRM) HAVING PLACE OF BUSINESS AT: 3, MARUTI INDUSTRIAL AREA, KOTHARIYA RING ROAD, B/H. MURLIDHAR WAYBRIDGE, N.H. 8B, RAJKOT-360003-GUJARAT-(INDIA)</b>		
<b>DATE OF REGISTRATION</b>	06/01/2014	
<b>TITLE</b>	LATCHES	
<b>PRIORITY NA</b>		

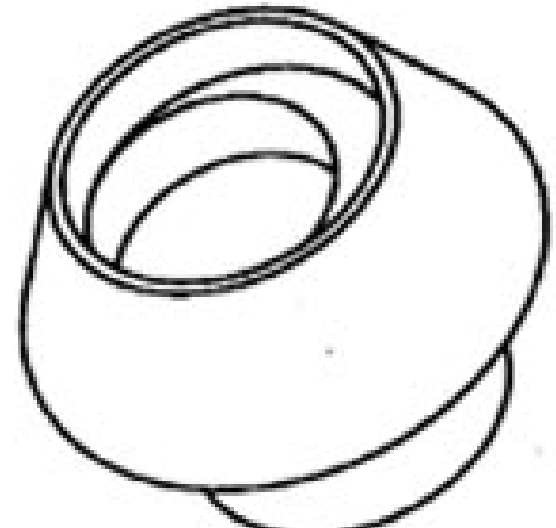
<b>DESIGN NUMBER</b>	259842	
<b>CLASS</b>	12-16	
<b>1)TATA MOTORS LIMITED, AN INDIAN COMPANY OF BOMBAY HOUSE, 24 HOMI MODY STREET, HUTATMA CHOWK, MUMBAI 400001, MAHARASHTRA, INDIA</b>		
<b>DATE OF REGISTRATION</b>	30/01/2014	
<b>TITLE</b>	DRAIN PLUG FOR AN AUTOMOBILE FUEL TANK	
<b>PRIORITY NA</b>		

<b>DESIGN NUMBER</b>	257239		
<b>CLASS</b>	06-08		
<b>1)SHREE SIMANDHAR INDUSTRIES IS A PROPRIETORSHIP FIRM OF</b> 21, NEW MANU BHUVAN, BHAGAT SINGH ROAD, VILE PARLE (W) MUMBAI-400056, MAHARASHTRA, INDIA			
<b>DATE OF REGISTRATION</b>	08/10/2013		
<b>TITLE</b>	HANGER		
<b>PRIORITY NA</b>			
<b>DESIGN NUMBER</b>	256871		
<b>CLASS</b>	07-01		
<b>1)SHRI RAM &amp; COMPANY AN INDIAN SOLE PROPRIETORSHIP FIRM AT 1/6,</b> <b>VIKRAM VIHAR, GURUDWARA ROAD, NEW DOUBLE STOREY, LAJPAT</b> <b>NAGAR-IV, NEW DELHI-110024</b> WHOSE PROPRIETOR IS GURDEEP SINGH AS AN INDIAN NATIONAL OF ABOVE ADDRESS			
<b>DATE OF REGISTRATION</b>	27/09/2013		
<b>TITLE</b>	MUG		
<b>PRIORITY NA</b>			
<b>DESIGN NUMBER</b>	258696		
<b>CLASS</b>	15-06		
<b>1)MASCHINENFABRIK RIETER AG,</b> A SWISS COMPANY OF KLOSTERSTRASSE 20, CH-8406 WINTERTHUR, SWITZERLAND			
<b>DATE OF REGISTRATION</b>	12/12/2013		
<b>TITLE</b>	THREAD SUCK-OFF DEVICE		
<b>PRIORITY</b>			
<b>PRIORITY NUMBER</b>	<b>DATE</b>	<b>COUNTRY</b>	
201330299798.0	20/06/2013	CHINA	

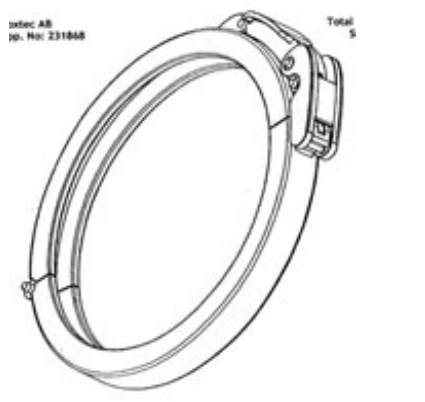
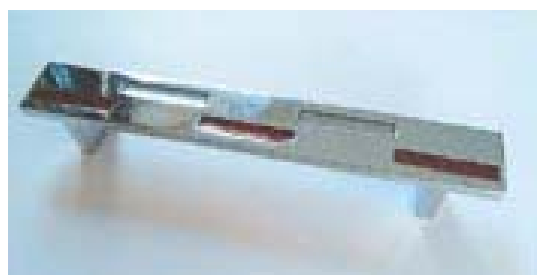
<b>DESIGN NUMBER</b>	258854		
<b>CLASS</b>	19-02		
<b>1)KANIN (INDIA) AT B-XXX-6754, FOCAL POINT, LUDHIANA-141010, PUNJAB, INDIA, AN INDIAN PARTNERSHIP FIRM, WHOSE PARTNERS ARE ARIHANT JAIN, VISHWA JAIN, MS. NEELAM JAIN, AMBRISH JAIN, GAUTAM JAIN AND AMIT JAIN (ALL INDIAN NATIONALS) HAVING THEIR ADDRESS OF B-XXX-6754, FOCAL POINT, LUDHIANA-141010, PUNJAB</b>			
<b>DATE OF REGISTRATION</b>	19/12/2013		
<b>TITLE</b>	STAPLER		
<b>PRIORITY NA</b>			
<b>DESIGN NUMBER</b>	231868		
<b>CLASS</b>	09-07		
<b>1)ROXTEC AB PO BOX 540 ROMBVAGEN, SE-371 23 KARLSKRONA, SWEDEN</b>			
<b>DATE OF REGISTRATION</b>	08/10/2010		
<b>TITLE</b>	CABLE AND PIPE PENETRATION SEALS		
<b>PRIORITY</b>			
<b>PRIORITY NUMBER</b>	<b>DATE</b>	<b>COUNTRY</b>	
001720723	16/06/2010	OHIM	
<b>DESIGN NUMBER</b>	256599		
<b>CLASS</b>	08-06		
<b>1)HARESHBHAI SAVJIBHA FACHARA (INDIAN NATIONAL) AND SOLE PROPRIETOR OF M/S. J. B. ENTERPRISE HAVING PLACE OF BUSINESS AT, PLOT NO. 01, SURVEY NO. 31, NR. RAJ FIBER, VAVDI, GONDAL ROAD, RAJKOT. (GUJARAT)</b>			
<b>DATE OF REGISTRATION</b>	19/09/2013		
<b>TITLE</b>	HANDLE		
<b>PRIORITY NA</b>			

<b>DESIGN NUMBER</b>	256076	
<b>CLASS</b>	14-02	
1)SAMSUNG ELECTRONICS CO., LTD., A KOREAN COMPANY, OF 129, SAMSUNG-RO, YEONGTONG-GU, SUWON-SI, GYEONGGI-DO, 443-742M REPUBLIC OF KOREA		
<b>DATE OF REGISTRATION</b>	27/08/2013	
<b>TITLE</b>	MONITOR	
<b>PRIORITY</b>		
<b>PRIORITY NUMBER</b>	<b>DATE</b>	<b>COUNTRY</b>
30-2013-0010365	27/02/2013	KOREA(SOUTH)

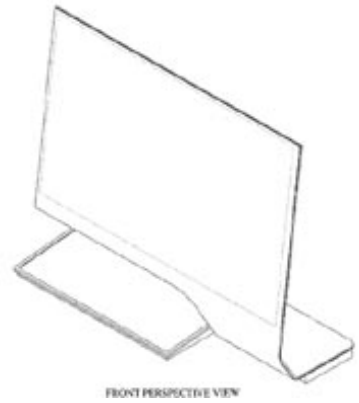

<b>DESIGN NUMBER</b>	258596	
<b>CLASS</b>	26-04	
1)KONINKLIJKE PHILIPS N.V., A COMPANY ORGANIZED AND EXISTING UNDER THE LAWS OF THE KINGDOM OF THE NETHERLANDS, RESIDING AT EINDHOVEN, WHOSE POST-OFFICE ADDRESS IS HIGH TECH CAMPUS 5, 5656 AE EINDHOVEN, THE NETHERLANDS		
<b>DATE OF REGISTRATION</b>	06/12/2013	
<b>TITLE</b>	LED BULB	
<b>PRIORITY</b>		
<b>PRIORITY NUMBER</b>	<b>DATE</b>	<b>COUNTRY</b>
002282392-0002	26/07/2013	OHIM



<b>DESIGN NUMBER</b>	258641	
<b>CLASS</b>	03-01	
1)VALENTINO S.P.A., A CORPORATION ORGANIZED AND EXISTING UNDER THE LAWS OF ITALY, OF VIA TURATI, 16/18, I-20121 MILANO, ITALY		
<b>DATE OF REGISTRATION</b>	09/12/2013	
<b>TITLE</b>	BAG	
<b>PRIORITY</b>		
<b>PRIORITY NUMBER</b>	<b>DATE</b>	<b>COUNTRY</b>
MI2013O000143	11/06/2013	ITALY

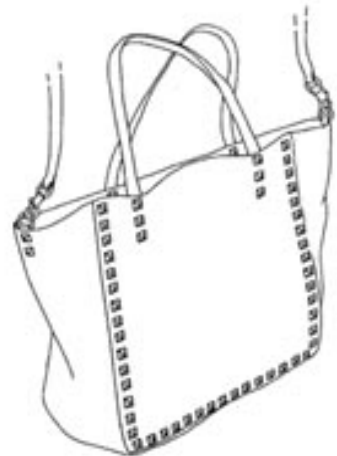

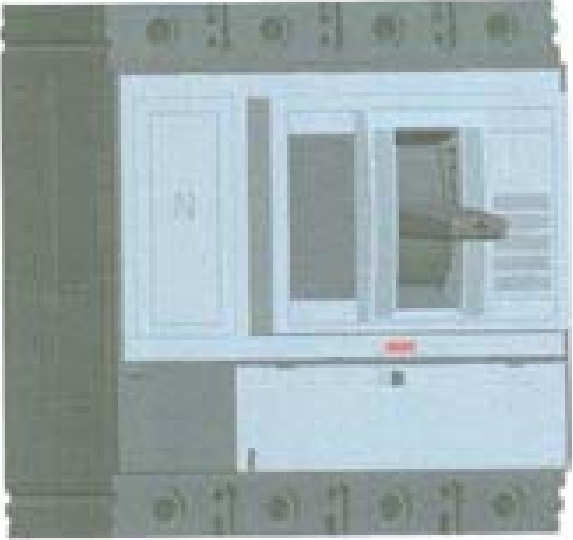
<b>DESIGN NUMBER</b>	257387	
<b>CLASS</b>	13-03	
<b>1) LARSEN &amp; TOUBRO LIMITED, AN INDIAN COMPANY INCORPORATED UNDER THE COMPANIES ACT, 1956 OF L &amp; T HOUSE, BALLARD ESTATE, MUMBAI 400001, STATE OF MAHARASHTRA, INDIA</b>		
<b>DATE OF REGISTRATION</b>	10/10/2013	
<b>TITLE</b>	MOULDED CASE CIRCUIT BREAKER	
<b>PRIORITY NA</b>		

<b>DESIGN NUMBER</b>	256852	
<b>CLASS</b>	07-02	
<b>1) BBM TECHNOLOGY LTD., AN ENGLISH COMPANY OF 132 BURNT ASH ROAD, LEE, LONDON, SE12 8PU</b>		
<b>DATE OF REGISTRATION</b>	27/09/2013	
<b>TITLE</b>	MOULD FOR MAKING FILTERS	
<b>PRIORITY</b>		
<b>PRIORITY NUMBER</b>	<b>DATE</b>	<b>COUNTRY</b>
002211052-0001	28/03/2013	OHIM

<b>DESIGN NUMBER</b>	253387	
<b>CLASS</b>	09-05	
<b>1) M/S EMAMI LIMITED, A COMPANY INCORPORATED UNDER INDIAN COMPANIES ACT, 1956 HAVING ITS REGISTERED OFFICE ADDRESS AT 687, ANANDAPUR, EM BYPASS, KOLKATA-700107, INDIA BY NATIONALITY INDIAN</b>		
<b>DATE OF REGISTRATION</b>	23/04/2013	
<b>TITLE</b>	PACKING TUBE WITH CAP	
<b>PRIORITY NA</b>		

<b>DESIGN NUMBER</b>	255214		
<b>CLASS</b>	13-03		
<b>1) LARSEN &amp; TOUBRO LIMITED, L&amp;T HOUSE, BALLARD ESTATE, P.O. BOX: 278, MUMBAI 400 001, MAHARASHTRA, INDIA</b> AN INDIAN COMPANY REGISTERED UNDER THE PROVISIONS OF THE COMPANIES ACT 1956			
<b>DATE OF REGISTRATION</b>	15/07/2013		
<b>TITLE</b>	MOULDED CASE CIRCUIT BREAKER		
<b>PRIORITY NA</b>			
<b>DESIGN NUMBER</b>	258719		
<b>CLASS</b>	14-01		
<b>1) BEATS ELECTRONICS, LLC, A LIMITED LIABILITY COMPANY OF DELAWARE,</b> OF 1601 CLOVERFIELD BLVD, SUITE 5000N, SANTA MONICA, CA 90404, U.S.A.			
<b>DATE OF REGISTRATION</b>	13/12/2013		
<b>TITLE</b>	EARPHONE LEVERAGE ATTACHMENTS SET		
<b>PRIORITY</b>			
<b>PRIORITY NUMBER</b>	<b>DATE</b>	<b>COUNTRY</b>	
29/457,923	13/06/2013	U.S.A.	
<b>DESIGN NUMBER</b>	253384		
<b>CLASS</b>	09-05		
<b>1) M/S EMAMI LIMITED, A COMPANY INCORPORATED UNDER INDIAN COMPANIES ACT, 1956 HAVING ITS REGISTERED OFFICE ADDRESS AT</b> 687, ANANDAPUR, EM BYPASS, KOLKATA-700107, INDIA BY NATIONALITY INDIAN			
<b>DATE OF REGISTRATION</b>	23/04/2013		
<b>TITLE</b>	PACKING TUBE WITH CAP		
<b>PRIORITY NA</b>			

<b>DESIGN NUMBER</b>	255213	
<b>CLASS</b>	13-03	
<b>1) LARSEN &amp; TOUBRO LIMITED, L&amp;T HOUSE, BALLARD ESTATE, P.O. BOX: 278, MUMBAI 400 001, MAHARASHTRA, INDIA</b> AN INDIAN COMPANY REGISTERED UNDER THE PROVISIONS OF THE COMPANIES ACT 1956		
<b>DATE OF REGISTRATION</b>	15/07/2013	
<b>TITLE</b>	MOULDED CASE CIRCUIT BREAKER	
<b>PRIORITY NA</b>		

<b>DESIGN NUMBER</b>	259635
<b>CLASS</b>	23-01
<b>1) TOUCH BATH JEWELS, A-54, MANAK VIHAR, NEAR-TILAK NAGAR, NEW DELHI-110018, INDIA.</b> (AN INDIAN PROPRIETORSHIP FIRM WHOSE PROPRIETOR IS:-SHASHI BHUSHAN AN INDIAN NATIONAL OF THE ABOVE ADDRESS	
<b>DATE OF REGISTRATION</b>	23/01/2014
<b>TITLE</b>	BATH TAP
<b>PRIORITY NA</b>	





<b>DESIGN NUMBER</b>	257409	
<b>CLASS</b>	12-16	
<b>1) VOLVO LASTVAGNAR AB, OF SE 405 08 GÖTEBORG, SWEDEN.</b>		
<b>DATE OF REGISTRATION</b>	10/10/2013	
<b>TITLE</b>	DIRT DEFLECTOR FOR VEHICLES	
<b>PRIORITY</b>		
<b>PRIORITY NUMBER</b>	<b>DATE</b>	<b>COUNTRY</b>
2013/0160	11/04/2013	SWEDEN





<b>DESIGN NUMBER</b>	239398	
<b>CLASS</b>	09-03	
<b>1)MANJUSHREE TECHNOPACK LIMITED</b> 143, C-5, BOMMASANDRA INDUSTRIAL AREA, HOSUR ROAD, BANGALORE-560099, KARNATAKA INDIA,		
<b>DATE OF REGISTRATION</b>	12/09/2011	
<b>TITLE</b>	BOTTLE NECK PREFORM	
<b>PRIORITY NA</b>		
<b>DESIGN NUMBER</b>	258834	
<b>CLASS</b>	09-01	
<b>1)DABUR INDIA LIMITED</b> CORPORATE OFFICE KAUSHAMBI, SAHIBABAD-201010, DISTT. GHAZIABAD (U.P.) INDIA, AN INDIAN COMPANY		
<b>DATE OF REGISTRATION</b>	18/12/2013	
<b>TITLE</b>	BOTTLE	
<b>PRIORITY NA</b>		
<b>DESIGN NUMBER</b>	256801	
<b>CLASS</b>	07-01	
<b>1)1) NISHITA THAKURDAS AND 2) ABDULLA JAMAL BOTH RESIDING AT 206, CHRISTELLA, VILLA NO. 6, WHITEFIELD MAIN ROAD, WHITEFIELD, BANGALORE 560066 KARNATAKA, INDIA</b> AND TRADING AS PARTNERS OF M/S. NISHITA DESIGN, SITUATED AT THE AFORE-MENTIONED ADDRESS		
<b>DATE OF REGISTRATION</b>	26/09/2013	
<b>TITLE</b>	PLATE	
<b>PRIORITY NA</b>		

<b>DESIGN NUMBER</b>	258879	
<b>CLASS</b>	09-01	
<b>1)GODREJ CONSUMER PRODUCTS LIMITED, AN INDIAN COMPANY HAVING ITS REGISTERED OFFICE AT PIROJSHANAGAR, EASTERN EXPRESS HIGHWAY, VIKHROLI, MUMBAI-400079, STATE OF MAHARASHTRA, INDIA</b>		
<b>DATE OF REGISTRATION</b>	19/12/2013	
<b>TITLE</b>	SOAP DISPENSER	
<b>PRIORITY NA</b>		
<b>DESIGN NUMBER</b>	258948	
<b>CLASS</b>	24-02	
<b>1)MR. SACHIN G. LOKAPURE(INDIA). PROPRIETOR OF SAGLO® RESEARCH EQUIPMENT HAVING ITS PRINCIPAL PLACE OF BUSINESS 5099, NEAR ASHA TALKIES, OPP. OMKAR APPT, SHANIWAR PETH, MIRAJ-416410, DIST-SANGLI, MAHARASHTRA, INDIA.</b>		
<b>DATE OF REGISTRATION</b>	24/12/2013	
<b>TITLE</b>	SAMPLE HOLDER FOR BACTERIAL MOVEMENT DETECTION	
<b>PRIORITY NA</b>		
<b>DESIGN NUMBER</b>	259634	
<b>CLASS</b>	02-04	
<b>1)ABHAY FOOTWEAR PVT. LTD., KH. NO. 76, OPP. PLOT NO. 1535, M.I.E., PART-B, BAHADURGAH, HARYANA, INDIA. (AN INDIAN COMPANY DULY REGISTERED UNDER THE COMPANIES ACT, 1956)</b>		
<b>DATE OF REGISTRATION</b>	23/01/2014	
<b>TITLE</b>	SOLE FOR FOOTWEAR	
<b>PRIORITY NA</b>		

<b>DESIGN NUMBER</b>	257407	
<b>CLASS</b>	12-16	
<b>1)VOLVO LASTVAGNAR AB, OF SE 405 08 GÖTEBORG, SWEDEN.</b>		
<b>DATE OF REGISTRATION</b>	10/10/2013	
<b>TITLE</b>	FOOTSTEP FOR VEHICLE	
<b>PRIORITY</b>		
<b>PRIORITY NUMBER</b>	<b>DATE</b>	<b>COUNTRY</b>
2013/0158	11/04/2013	SWEDEN





<b>DESIGN NUMBER</b>	258560	
<b>CLASS</b>	26-05	
<b>1)NATIONAL INSTITUTE OF DESIGN LOCATED AT PALDI, AHMEDABAD-380007, GUJARAT, HAVING NATIONALITY AS INDIAN</b>		
<b>DATE OF REGISTRATION</b>	05/12/2013	
<b>TITLE</b>	LAMP	
<b>PRIORITY NA</b>		



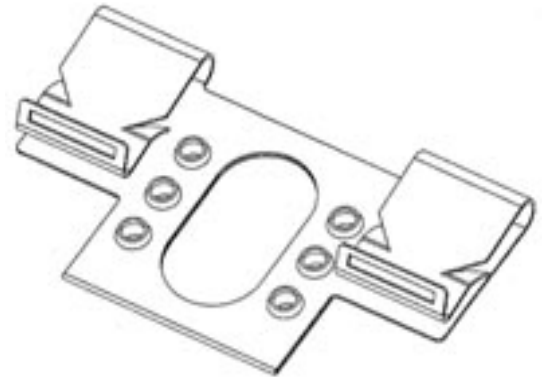

<b>DESIGN NUMBER</b>	256441	
<b>CLASS</b>	08-08	
<b>1)HUBBELL INCORPORATED, 40 WATERVIEW DRIVE, P.O. BOX 1000, SHELTON, CONNECTICUT 06484-1000 UNITED STATES, A CORPORATION OF THE STATE OF CONNECTICUT, USA</b>		
<b>DATE OF REGISTRATION</b>	13/09/2013	
<b>TITLE</b>	CLIP-ON BONDING WASHER	
<b>PRIORITY</b>		
<b>PRIORITY NUMBER</b>	<b>DATE</b>	<b>COUNTRY</b>
29/450,142	15/03/2013	U.S.A.





<b>DESIGN NUMBER</b>	256874		
<b>CLASS</b>	09-05		
<b>1)LUXOR WRITING INSTRUMENTS PVT. LIMITED, AN INDIAN COMPANY, OF</b> 229, OKHLA INDUSTRIAL ESTATE, PHASE-III, NEW DELHI, INDIA			
<b>DATE OF REGISTRATION</b>	27/09/2013		
<b>TITLE</b>	PACKAGING TRAY		
<b>PRIORITY NA</b>			
<b>DESIGN NUMBER</b>	258994		
<b>CLASS</b>	08-06		
<b>1)HITESHBHAI VALLABHBHAI AMIPARA AND VALLABHBHAI DEVDASBHAI AMIPARA BOTH INDIAN NATIONAL PARTNER OF SIGMA ENTERPRISE AN INDIAN PARTNERSHIP FIRM HAVING ITS PRINCIPAL PLACE OF BUSINESS AT</b> SHRI HARI IND. ZONE-2, NR. MUNJAPARA INDUSTRIES, AKASH RESTAURANT STREET, AJI RING ROAD, RAJKOT-2, GUJARAT-INDIA			
<b>DATE OF REGISTRATION</b>	24/12/2013		
<b>TITLE</b>	HANDLE		
<b>PRIORITY NA</b>			
<b>DESIGN NUMBER</b>	255539		
<b>CLASS</b>	22-06		
<b>1)RECKITT BENCKISER (BRANDS) LIMITED,</b> 103-105 BATH ROAD, SLOUGH BERKSHIRE, SL1 3UH, UNITED KINGDOM			
<b>DATE OF REGISTRATION</b>	29/07/2013		
<b>TITLE</b>	REFILL FOR INSECT REPELLENT DEVICE		
<b>PRIORITY</b>			
<b>PRIORITY NUMBER</b>	<b>DATE</b>	<b>COUNTRY</b>	
002175349-0004	30/01/2013	OHIM	

<b>DESIGN NUMBER</b>	257506	
<b>CLASS</b>	02-04	
<b>1)B. KRISHNA KUMAR, PROPRIETOR OF M/S. STEPSTONE CLOTHING, AT NO. 46, SIDCO, INDUSTRIAL ESTATE, HARVEY ROAD, TIRUPUR-641602, TIRUPUR DISTRICT, TAMILNADU, INDIA, INDIAN-NATIONAL OF ABOVE ADDRESS</b>		
<b>DATE OF REGISTRATION</b>	14/10/2013	
<b>TITLE</b>	FOOT WEAR	
<b>PRIORITY NA</b>		
<b>DESIGN NUMBER</b>	257360	
<b>CLASS</b>	07-01	
<b>1)RAVISSANT PRIVATE LIMITED, AN INDIAN COMPANY, OF 50-51, COMMERCIAL COMPLEX, NEW FRIENDS COLONY, NEW DELHI-110065, INDIA</b>		
<b>DATE OF REGISTRATION</b>	09/10/2013	
<b>TITLE</b>	SERVING DISH	
<b>PRIORITY NA</b>		
<b>DESIGN NUMBER</b>	257112	
<b>CLASS</b>	09-05	
<b>1)LUXOR WRITING INSTRUMENTS PVT. LIMITED, AN INDIAN COMPANY, OF 229, OKHLA INDUSTRIAL ESTATE, PHASE-III, NEW DELHI, INDIA</b>		
<b>DATE OF REGISTRATION</b>	30/09/2013	
<b>TITLE</b>	BLISTER PACK	
<b>PRIORITY NA</b>		

<b>DESIGN NUMBER</b>	258508	
<b>CLASS</b>	06-01	
<b>1)THE SUPREME INDUSTRIES LTD., (AN INDIAN PUBLIC LIMITED COMPANY),</b> 601 CENTRAL PLAZA, 2/6, SARAT BOSE ROAD, KOLKATA - 700020, WEST BENGAL, INDIA		
<b>DATE OF REGISTRATION</b>	02/12/2013	
<b>TITLE</b>	CHAIR	
<b>PRIORITY NA</b>		

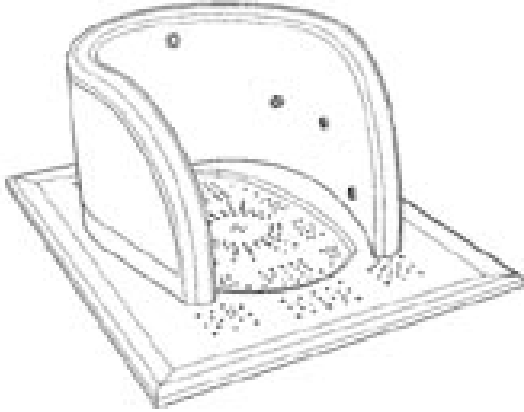

<b>DESIGN NUMBER</b>	259008	
<b>CLASS</b>	09-07	
<b>1)MONO PACKAGING PVT. LTD., 506-A, SHREENATH COMPLEX, P.K. ROAD EXTENSION, MULUND (WEST),</b> MUMBAI-400080, INDIA. (AN INDIAN COMPANY DULY REGISTERED UNDER THE COMPANIES ACT, 1956)		
<b>DATE OF REGISTRATION</b>	26/12/2013	
<b>TITLE</b>	JAR CAP	
<b>PRIORITY NA</b>		

<b>DESIGN NUMBER</b>	259420	
<b>CLASS</b>	23-02	
<b>1)BOLD INTERNATIONAL FZCO, A COMPANY ORGANIZED AND EXISTING UNDER THE LAWS OF UNITED ARAB EMIRATES,</b> <b>HAVING PLACE OF BUSINESS AT</b> PO BOX 261691 JAFZA, DUBAI, UNITED ARAB EMIRATES		
<b>DATE OF REGISTRATION</b>	15/01/2014	
<b>TITLE</b>	FOOT WASHER	
<b>PRIORITY</b>		
<b>PRIORITY NUMBER</b>	<b>DATE</b>	<b>COUNTRY</b>
001380919-0001	13/08/2013	OHIM

<b>DESIGN NUMBER</b>	256826	
<b>CLASS</b>	02-01	
<b>1) GALAXY CLOTHING CO., (AN INDIAN SOLE PROPRIETORSHIP CONCERN), HAVING OFFICE AT GALA NO. 212, SHREEJI INDUSTRIAL ESTATE, SUBHASH ROAD, JOGESHWARI (EAST), MUMBAI-400060, MAHARASHTRA, INDIA.</b> WHOSE PROPRIETOR IS NIMESH SHAH. (INDIAN NATIONAL) OF ABOVE ADDRESS.		
<b>DATE OF REGISTRATION</b>	26/09/2013	
<b>TITLE</b>	SHIRT	
<b>PRIORITY NA</b>		

<b>DESIGN NUMBER</b>	257368	
<b>CLASS</b>	07-01	
<b>1) RAVISSANT PRIVATE LIMITED, AN INDIAN COMPANY, OF 50-51, COMMERCIAL COMPLEX, NEW FRIENDS COLONY, NEW DELHI-110065, INDIA</b>		
<b>DATE OF REGISTRATION</b>	09/10/2013	
<b>TITLE</b>	DISH	
<b>PRIORITY NA</b>		

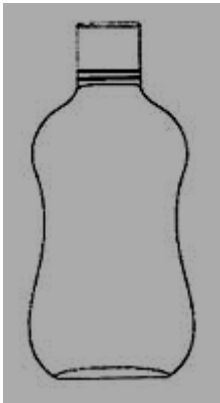
<b>DESIGN NUMBER</b>	256825	
<b>CLASS</b>	02-01	
<b>1) GALAXY CLOTHING CO., (AN INDIAN SOLE PROPRIETORSHIP CONCERN), HAVING OFFICE AT GALA NO. 212, SHREEJI INDUSTRIAL ESTATE, SUBHASH ROAD, JOGESHWARI (EAST), MUMBAI-400 060, MAHARASHTRA, INDIA.</b> WHOSE PROPRIETOR IS NIMESH SHAH. (INDIAN NATIONAL) OF ABOVE ADDRESS		
<b>DATE OF REGISTRATION</b>	26/09/2013	
<b>TITLE</b>	SHIRT	
<b>PRIORITY NA</b>		

<b>DESIGN NUMBER</b>	260447	
<b>CLASS</b>	09-03	
<b>1) ABBOTT HEALTHCARE PVT. LTD, AN INDIAN COMPANY HAVING ITS OFFICE AT</b> 4, CORPORATE PARK, SION-TROMBAY ROAD, MUMBAI-400071, MAHARASHTRA, INDIA		
<b>DATE OF REGISTRATION</b>	18/02/2014	
<b>TITLE</b>	CONTAINER	
<b>PRIORITY NA</b>		
<b>DESIGN NUMBER</b>	257505	
<b>CLASS</b>	09-04	
<b>1) S. SINDHIYA, PROPRIETOR OF M/S. SINDHIYA PLASTIC INDUSTRIES, AT</b> NO. 75/1, THIRUNAGAR 3RD STREET, SUNDAKKAMUTHUR ROAD, COIMBATORE-641026, TAMILNADU, INDIA, INDIAN-NATIONAL OF ABOVE ADDRESS		
<b>DATE OF REGISTRATION</b>	14/10/2013	
<b>TITLE</b>	BASKET	
<b>PRIORITY NA</b>		
<b>DESIGN NUMBER</b>	257359	
<b>CLASS</b>	07-01	
<b>1) RAVISSANT PRIVATE LIMITED, AN INDIAN COMPANY, OF</b> 50-51, COMMERCIAL COMPLEX, NEW FRIENDS COLONY, NEW DELHI-110065, INDIA		
<b>DATE OF REGISTRATION</b>	09/10/2013	
<b>TITLE</b>	COFFEE POT	
<b>PRIORITY NA</b>		



<b>DESIGN NUMBER</b>	258681	
<b>CLASS</b>	12-16	
<b>1)NISSAN JIDOSHA KABUSHIKI KAISHA (ALSO TRADING AS NISSAN MOTOR CO., LTD.), A JAPANESE COMPANY, ORGANIZED AND EXISTING UNDER THE LAWS OF JAPAN OF</b> NO. 2 TAKARACHO, KANAGAWA-KU, YOKOHAMA-SHI, KANAGAWA-KEN, JAPAN		
<b>DATE OF REGISTRATION</b>	12/12/2013	
<b>TITLE</b>	INSTRUMENT PANEL FOR AUTOMOBILE	
<b>PRIORITY NA</b>		

<b>DESIGN NUMBER</b>	255263	
<b>CLASS</b>	26-03	
<b>1)HAVELLS INDIA LIMITED HAVING REGISTERED OFFICE AT 1, RAJ NARAIN MARG, CIVIL LINES, DELHI 110054.</b>		
<b>DATE OF REGISTRATION</b>	16/07/2013	
<b>TITLE</b>	LUMINAIRE	
<b>PRIORITY NA</b>		

<b>DESIGN NUMBER</b>	257358	
<b>CLASS</b>	07-01	
<b>1)RAVISSANT PRIVATE LIMITED, AN INDIAN COMPANY, OF 50-51, COMMERCIAL COMPLEX, NEW FRIENDS COLONY, NEW DELHI-110065, INDIA</b>		
<b>DATE OF REGISTRATION</b>	09/10/2013	
<b>TITLE</b>	TEA POT	
<b>PRIORITY NA</b>		

<b>DESIGN NUMBER</b>	258571	
<b>CLASS</b>	09-03	
<b>1)TETRA LAVAL HOLDINGS &amp; FINANCE S.A., OF AVENUE GÉNÉRAL-GUISAN 70, CH-1009 PULLY, 1009 SWITZERLAND</b>		
<b>DATE OF REGISTRATION</b>	05/12/2013	
<b>TITLE</b>	PACKAGING	
<b>PRIORITY</b>		
<b>PRIORITY NUMBER</b>	<b>DATE</b>	<b>COUNTRY</b>
002282137-0011	26/07/2013	OHIM

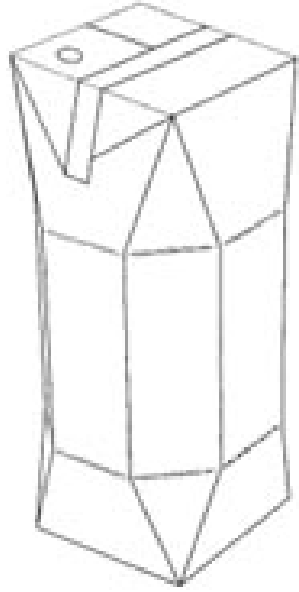



<b>DESIGN NUMBER</b>	259186	
<b>CLASS</b>	23-01	
<b>1)EASOL PRIVATE LIMITED AN INDIAN COMPANY ESTABLISHED UNDER THE COMPANY'S ACT, 1956 AND WHOSE ADDRESS IS S. NO. 228, OPP. SHIVANE GRAMPANCHAYAT, AT POST SHIVANE, TALUKA-HAVELI, PUNE:411023, MAHARASHTRA, INDIA</b>		
<b>DATE OF REGISTRATION</b>	03/01/2014	
<b>TITLE</b>	WATER DISINFECTANT DEVICE	
<b>PRIORITY NA</b>		



<b>DESIGN NUMBER</b>	255232	
<b>CLASS</b>	15-99	
<b>1)DANIELI &amp; C. OFFICINE MECCANICHE S.P.A., AN ITALIAN COMPANY, OF VIA NAZIONALE, 41, 33042 BUTTRIO (UD), ITALY</b>		
<b>DATE OF REGISTRATION</b>	15/07/2013	
<b>TITLE</b>	SLITTING GUIDES FOR ROLLING MILLS	
<b>PRIORITY NA</b>		



<b>DESIGN NUMBER</b>	259650	
<b>CLASS</b>	02-04	
<b>1)ANISH GOYAL, PROPRIETOR OF MARUTI FOOTWEAR COMAPNY AND HAVING ITS OFFICE</b> PLOT NO. 218 MIA, PART A, BHADURGARH, HARYANA-124507		
<b>DATE OF REGISTRATION</b>	24/01/2014	
<b>TITLE</b>	FOOTWEAR	
<b>PRIORITY NA</b>		

<b>DESIGN NUMBER</b>	257356	
<b>CLASS</b>	07-01	
<b>1)RAVISSANT PRIVATE LIMITED, AN INDIAN COMPANY, OF</b> 50-51, COMMERCIAL COMPLEX, NEW FRIENDS COLONY, NEW DELHI-110065, INDIA		
<b>DATE OF REGISTRATION</b>	09/10/2013	
<b>TITLE</b>	TEA POT	
<b>PRIORITY NA</b>		