

## ***CONTINUED FROM PART- 1***

### **INTRODUCTION**

In view of the recent amendment made in the Designs (Amendment) Rules, 2008 with effect from 17/06/2008, Publication of the matter relating to Designs is being published in the Official Journal of The Patent Office. This Journal is being published on weekly basis on every Friday covering the various proceedings on Designs as required according to the provisions of under Rule 22, 25, 27 and 39 of the Design (Amendment) Rules, 2008. All the enquiries on this Official Journal and other information as required by the public should be addressed to the Controller General of Patents, Designs & Trade Marks. Suggestions and comments are requested from all quarters so that the content can be enriched.

## COPYRIGHT PUBLICATION

<b>SL NO</b>	<b>REGISTERED DESIGN NUMBERS</b>	<b>RENEWED ON</b>
1.	193612	20.06.2014
2.	193698	24.07.2014
3.	194254	24.07.2014
4.	195009	18.07.2014
5.	197401	18.07.2014
6.	197403	18.07.2014
7.	197404	18.07.2014
8.	197406	18.07.2014
9.	197402	18.07.2014
10.	197411	18.07.2014
11.	197412	18.07.2014
12.	227760	23.07.2014
13.	193096	27.06.2014
14.	193097	27.06.2014
15.	193098	27.06.2014

**THE DESIGNS ACT 2000**  
**SECTION 30**  
**DESIGN ASSIGNMENT**

The Design stands in the name of NOKIA CORPORATION registered under the Designs Act, 2000 has been assigned in the Register of Designs in the name as follows:-

Design Nos.	Class	Name
223736, 223738, 223733, 223735, 223734, 223737, 240594, 240595, 240596, 230410, 230420, 232457	14-03 232457(14-99) 223738(19-06) 223737(14-02)	VERTU CORPORATION LIMITED, A COMPANY ORGANISED AND EXISTING UNDER THE LAWS OF UNITED KINGDOM OF THE ADDRESS BEACON HILL ROAD, CHURCH CROOKHAM, HAMPSHIRE GU52 8DY, UNITED KINGDOM

## REGISTRATION OF DESIGNS

The following designs have been registered. They are now open for public inspection. In the following each entry the Date of Registration is shown. The Priority Number, Priority Date and Priority Country are also shown

<b>DESIGN NUMBER</b>	258757		
<b>CLASS</b>	26-05		
<b>1)INMARK EXPORTS PVT LTD, AN INDIAN COMPANY HAVING ITS OFFICE AT</b> 306-307, USHA CHAMBERS, COMMERCIAL COMPLEX, NEW RAJDHANI ENCLAVE, VIKAS MARG, NEW DELHI-110092			
<b>DATE OF REGISTRATION</b>	16/12/2013		
<b>TITLE</b>	LAMP SHADE		
<b>PRIORITY NA</b>			
<b>DESIGN NUMBER</b>	251180		
<b>CLASS</b>	08-06		
<b>1)HITESHBHAI KHODABHAI LUNAGARIYA (ADULT, &amp; INDIAN NATIONAL) HAVING PLACE OF BUSINESS AT:</b> "SARTHI" 15, RAJLAXMI SOCIETY, KOTHARIYA MAIN ROAD, OPP-HUDKO POLICE CHOWKI, RAJKOT-GUJARAT (INDIA)			
<b>DATE OF REGISTRATION</b>	24/01/2013		
<b>TITLE</b>	HANDLE		
<b>PRIORITY NA</b>			
<b>DESIGN NUMBER</b>	257393		
<b>CLASS</b>	12-08		
<b>1)VOLVO LASTVAGNAR AB, OF</b> SE 405 08 GÖTEBORG, SWEDEN			
<b>DATE OF REGISTRATION</b>	10/10/2013		
<b>TITLE</b>	TRUCK CAB		
<b>PRIORITY</b>			
<b>PRIORITY NUMBER</b>	<b>DATE</b>		<b>COUNTRY</b>
2013/0146	11/04/2013		SWEDEN
<b>PRIORITY NA</b>			

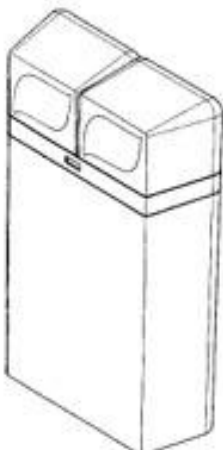
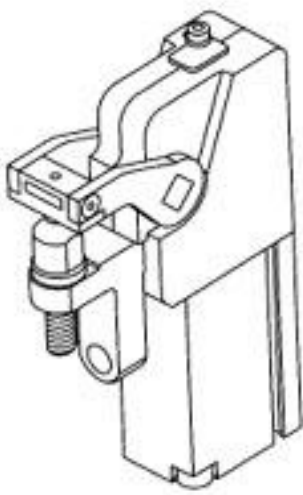
<b>DESIGN NUMBER</b>	258373							
<b>CLASS</b>	09-01							
<b>1) VASA GLOBAL COMPANY., 101-106, NAIN KRUPA, 118/122, KAZI SAYED STREET, MUMBAI-400023, INDIAN, STATE OF MAHARASHTRA, (INDIA), INDIAN PARTNERSHIP FIRM, INDIAN NATIONALS WHOSE PARTNERS ARE:-</b> 1. MAYANK DEVCHAND VASA, 2. BHAVIKA MAYANK VASA, INDIAN NATIONALS, OF ABOVE ADDRESS								
<b>DATE OF REGISTRATION</b>	26/11/2013							
<b>TITLE</b>	BOTTLE							
<b>PRIORITY NA</b>								
<b>DESIGN NUMBER</b>	258060							
<b>CLASS</b>	09-03							
<b>1) SOREMARTEC S.A., A LUXEMBOURGIAN JOINT STOCK COMPANY OF FINDEL BUSINESS CENTER, COMPLEXE B, RUE DE TRÈVES, L-2632 FINDEL (LUXEMBOURG)</b>								
<b>DATE OF REGISTRATION</b>	11/11/2013							
<b>TITLE</b>	BOX							
<b>PRIORITY</b>								
<table border="1"> <thead> <tr> <th>PRIORITY NUMBER</th> <th>DATE</th> <th>COUNTRY</th> </tr> </thead> <tbody> <tr> <td>738025801</td> <td>15/05/2013</td> <td>WIPO</td> </tr> </tbody> </table>			PRIORITY NUMBER	DATE	COUNTRY	738025801	15/05/2013	WIPO
PRIORITY NUMBER	DATE	COUNTRY						
738025801	15/05/2013	WIPO						
<b>DESIGN NUMBER</b>	257324							
<b>CLASS</b>	15-09							
<b>1) SMC KABUSHIKI KAISHA, A JAPANESE CORPORATION OF 4-14-1, SOTOKANDA, CHIYODA-KU, TOKYO 101-0021, JAPAN</b>								
<b>DATE OF REGISTRATION</b>	09/10/2013							
<b>TITLE</b>	CLAMPING DEVICE FOR SECURING A WORKPIECE							
<b>PRIORITY</b>								
<table border="1"> <thead> <tr> <th>PRIORITY NUMBER</th> <th>DATE</th> <th>COUNTRY</th> </tr> </thead> <tbody> <tr> <td>2013-008753</td> <td>18/04/2013</td> <td>JAPAN</td> </tr> </tbody> </table>			PRIORITY NUMBER	DATE	COUNTRY	2013-008753	18/04/2013	JAPAN
PRIORITY NUMBER	DATE	COUNTRY						
2013-008753	18/04/2013	JAPAN						

<b>DESIGN NUMBER</b>	257685		
<b>CLASS</b>	12-08		
<b>1)ISUZU MOTORS LIMITED, A JAPANESE CORPORATION, MANUFACTURER OF 6-26-1, MINAMI-OI, SHINAGAWA-KU, TOKYO 140-8722, JAPAN</b>			
<b>DATE OF REGISTRATION</b>	23/10/2013		
<b>TITLE</b>	CAR		
<b>PRIORITY</b>			
<b>PRIORITY NUMBER</b>	<b>DATE</b>	<b>COUNTRY</b>	
2013-009417	26/04/2013	JAPAN	
<b>DESIGN NUMBER</b>	258929		
<b>CLASS</b>	24-04		
<b>1)GLENMARK PHARMACEUTICALS LTD., A COMPANY REGISTERED UNDER THE COMPANIES ACT, 1956 (INDIAN NATIONAL) AND HAVING ITS PRINCIPAL PLACE OF BUSINESS AT B/2, MAHALAXMI CHAMBERS, 22, BHULABHAI DESAI ROAD, MUMBAI - 400026, MAHARASHTRA, INDIA, (INDIAN NATIONAL)</b>			
<b>DATE OF REGISTRATION</b>	23/12/2013		
<b>TITLE</b>	INHALER		
<b>PRIORITY NA</b>			
<b>DESIGN NUMBER</b>	258758		
<b>CLASS</b>	06-11		
<b>1)SH. JAGMOHAN SHARMA, 49, VIVEKANAND PURI, DELHI-110007, (INDIA) AN INDIAN NATIONAL OF THE ABOVE ADDRESS</b>			
<b>DATE OF REGISTRATION</b>	16/12/2013		
<b>TITLE</b>	DOORMAT		
<b>PRIORITY NA</b>			

<b>DESIGN NUMBER</b>	256643	
<b>CLASS</b>	24-03	
<b>1)SAHAJANAND MEDICAL TECHNOLOGIES (P) LTD, AN INDIAN COMPANY, REGD. OFFICE AT SAHAJANAND ESTATE, WAKHARIAWADI, NEAR DABHOLI, VED ROAD, SURAT-395004, GUJARAT, INDIA</b>		
<b>DATE OF REGISTRATION</b>	20/09/2013	
<b>TITLE</b>	CORONARY STENT	
<b>PRIORITY NA</b>		
<b>DESIGN NUMBER</b>	257390	
<b>CLASS</b>	12-16	
<b>1)M/S. NAGI TOOLS; A PROPRIETORSHIP CONCERN REPRESENTED THROUGH ITS SOLE PROPRIETOR MR. ARVINDER SINGH, AN INDIAN NATIONAL, OF THE ADDRESS: 3-B/4, VISHNU GARDEN, NEW DELHI-110018, INDIA</b>		
<b>DATE OF REGISTRATION</b>	10/10/2013	
<b>TITLE</b>	SAFETY FRONT GUARD FOR VEHICLES	
<b>PRIORITY NA</b>		
<b>DESIGN NUMBER</b>	258371	
<b>CLASS</b>	09-01	
<b>1)VASA GLOBAL COMPANY., 101-106, NAIN KRUPA, 118/122, KAZI SAYED STREET, MUMBAI-400023, INDIAN, STATE OF MAHARASHTRA, (INDIA), INDIAN PARTNERSHIP FIRM, INDIAN NATIONALS WHOSE PARTNERS ARE:- 1. MAYANK DEVCHAND VASA, 2. BHAVIKA MAYANK VASA, INDIAN NATIONALS, OF ABOVE ADDRESS</b>		
<b>DATE OF REGISTRATION</b>	26/11/2013	
<b>TITLE</b>	BOTTLE	
<b>PRIORITY NA</b>		

<b>DESIGN NUMBER</b>	256525		
<b>CLASS</b>	15-07		
<b>1)BSH BOSCH UND SIEMENS HAUSGERÄTE GMBH, OF CARL-WERY - STR.34, 81739, MUNICH, GERMANY, A GERMAN COMPANY</b>			
<b>DATE OF REGISTRATION</b>	16/09/2013		
<b>TITLE</b>	REFRIGERATOR		
<b>PRIORITY NA</b>			
<b>DESIGN NUMBER</b>	257211		
<b>CLASS</b>	25-01		
<b>1)STANDARD BELEX (INDIA) PVT. LTD. (A COMPANY INCORPORATED UNDER THE COMPANIES ACT, 1956) HAVING ITS PRINCIPAL PLACE OF BUSINESS AT ADDRESS PLOT NO. 463, G.I.D.C. ESTATE, POR-RAMANGAMDI-391243, DIST.: VADODARA, GUJARAT-INDIA</b>			
<b>DATE OF REGISTRATION</b>	04/10/2013		
<b>TITLE</b>	CONCRETE FORM WORK FRAME		
<b>PRIORITY NA</b>			
<b>DESIGN NUMBER</b>	257395		
<b>CLASS</b>	12-08		
<b>1)VOLVO LASTVAGNAR AB, OF SE 405 08 GÖTEBORG, SWEDEN</b>			
<b>DATE OF REGISTRATION</b>	10/10/2013		
<b>TITLE</b>	TRUCK CAB		
<b>PRIORITY</b>			
<b>PRIORITY NUMBER</b>	<b>DATE</b>	<b>COUNTRY</b>	
2013/0147	11/04/2013	SWEDEN	





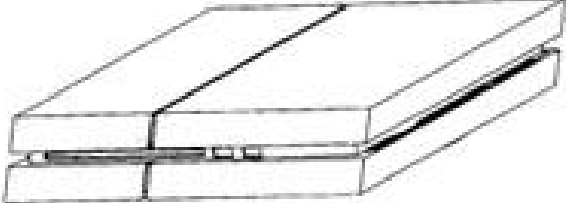

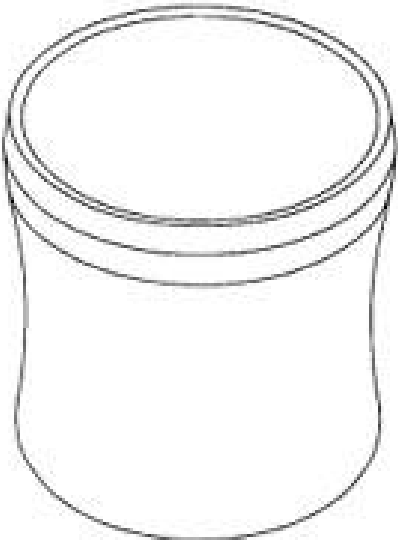

<b>DESIGN NUMBER</b>	258382	
<b>CLASS</b>	23-01	
<b>1)MANSUKHBHAI G. PATEL AN INDIAN NATIONAL SOLE PROPRIETOR OF SHREE UMIYA PLASTIC AN INDIAN PROPRIETORSHIP FIRM HAVING ITS PRINCIPAL PLACE OF BUSINESS AT</b> 49-50, KRISHNA INDUSTRIAL ESTATE, OPP. AMRUTA SCHOOL, NEAR RABARI COLONY, AMRAIWADI, AHMEDABAD-26, GUJARAT-INDIA		
<b>DATE OF REGISTRATION</b>	26/11/2013	
<b>TITLE</b>	WATER DISTRIBUTION UNIT FOR IRRIGATION SYSTEMS	
<b>PRIORITY NA</b>		

<b>DESIGN NUMBER</b>	258062	
<b>CLASS</b>	14-02	
<b>1)SONY COMPUTER ENTERTAINMENT INC., A JAPANESE COMPANY OF</b> 1-7-1, KONAN, MINATO-KU, TOKYO, JAPAN		
<b>DATE OF REGISTRATION</b>	11/11/2013	
<b>TITLE</b>	ARITHMETIC AND CONTROL UNIT	
<b>PRIORITY</b>		
<b>PRIORITY NUMBER</b>	<b>DATE</b>	<b>COUNTRY</b>
2013-010775	16/05/2013	JAPAN

<b>DESIGN NUMBER</b>	258185	
<b>CLASS</b>	26-05	
<b>1)PANASONIC CORPORATION, A JAPANESE COMPANY ORGANIZED AND EXISTING UNDER THE LAWS OF JAPAN,</b> OF 1006, OAZA KADOMA, KADOMA-SHI, OSAKA 571-8501, JAPAN		
<b>DATE OF REGISTRATION</b>	18/11/2013	
<b>TITLE</b>	HANGING LIGHT	
<b>PRIORITY</b>		
<b>PRIORITY NUMBER</b>	<b>DATE</b>	<b>COUNTRY</b>
2013-011100	21/05/2013	JAPAN

<b>DESIGN NUMBER</b>	256283		
<b>CLASS</b>	23-02		
<b>1)NEOPERL GMBH, KLOSTERRUNSSTR. 11, 79379 MÜLLHEIM, GERMANY, A GERMAN COMPANY</b>			
<b>DATE OF REGISTRATION</b>	06/09/2013		
<b>TITLE</b>	FAUCET AERATOR		
<b>PRIORITY</b>			
<b>PRIORITY NUMBER</b>	<b>DATE</b>	<b>COUNTRY</b>	
725018001	08/03/2013	WIPO	
<b>DESIGN NUMBER</b>	257394		
<b>CLASS</b>	21-01		
<b>1)VOLVO LASTVAGNAR AB, OF SE 405 08 GÖTEBORG, SWEDEN</b>			
<b>DATE OF REGISTRATION</b>	10/10/2013		
<b>TITLE</b>	TOY TRUCK CAB		
<b>PRIORITY</b>			
<b>PRIORITY NUMBER</b>	<b>DATE</b>	<b>COUNTRY</b>	
2013-0146	11/04/2013	SWEDEN	
<b>DESIGN NUMBER</b>	258381		
<b>CLASS</b>	23-01		
<b>1)MANSUKHBHAI G. PATEL AN INDIAN NATIONAL SOLE PROPRIETOR OF SHREE UMIYA PLASTIC AN INDIAN PROPRIETORSHIP FIRM HAVING ITS PRINCIPAL PLACE OF BUSINESS AT 49-50, KRISHNA INDUSTRIAL ESTATE, OPP. AMRUTA SCHOOL, NEAR RABARI COLONY, AMRAIWADI, AHMEDABAD-26, GUJARAT- INDIA</b>			
<b>DATE OF REGISTRATION</b>	26/11/2013		
<b>TITLE</b>	WATER DISTRIBUTION UNIT FOR IRRIGATION SYSTEMS		
<b>PRIORITY NA</b>			

<b>DESIGN NUMBER</b>	258061		
<b>CLASS</b>	09-01		
<b>1)SOREMARTEC S.A., A LUXEMBOURGIAN JOINT STOCK COMPANY OF FINDEL BUSINESS CENTER, COMPLEXE B, RUE DE TRÈVES, L-2632 FINDEL (LUXEMBOURG)</b>			
<b>DATE OF REGISTRATION</b>	11/11/2013		
<b>TITLE</b>	JAR		
<b>PRIORITY</b>			
<b>PRIORITY NUMBER</b>	<b>DATE</b>	<b>COUNTRY</b>	
738025801	15/05/2013	WIPO	
<b>DESIGN NUMBER</b>	257218		
<b>CLASS</b>	25-01		
<b>1)STANDARD BELEX (INDIA) PVT. LTD. (A COMPANY INCORPORATED UNDER THE COMPANIES ACT, 1956) HAVING ITS PRINCIPAL PLACE OF BUSINESS AT ADDRESS PLOT NO. 463, G.I.D.C. ESTATE, POR-RAMANGAMDI-391243, DIST.: VADODARA, GUJARAT-INDIA</b>			
<b>DATE OF REGISTRATION</b>	04/10/2013		
<b>TITLE</b>	CONCRETE FORM WORK FRAME		
<b>PRIORITY NA</b>			
<b>DESIGN NUMBER</b>	256156		
<b>CLASS</b>	15-99		
<b>1)M/S RECMECH ENVIRO PVT. LTD., (A COMPANY INCORPORATED UNDER INDIAN COMPANIES ACT, 1956), SHOP NO. 4, DDA SHOPPING COMPLEX, HARGOBIND ENCLAVE, VIKAS MARG EXTENSION, DELHI-110092., (INDIA)</b>			
<b>DATE OF REGISTRATION</b>	02/09/2013		
<b>TITLE</b>	WALL MOUNTED CRUSHER		
<b>PRIORITY NA</b>			

<b>DESIGN NUMBER</b>	256327		
<b>CLASS</b>	27-04		
<b>1)ITC LIMITED, AN INDIAN COMPANY WITHIN THE MEANING OF THE COMPANIES ACT, 1956 OF VIRGINIA HOUSE, 37, J. L. NEHRU ROAD, KOLKATA - 700071, WEST BENGAL, INDIA</b>			
<b>DATE OF REGISTRATION</b>	09/09/2013		
<b>TITLE</b>	MATCH BOX		
<b>PRIORITY NA</b>			
<b>DESIGN NUMBER</b>	257396		
<b>CLASS</b>	21-01		
<b>1)VOLVO LASTVAGNAR AB, OF SE 405 08 GÖTEBORG, SWEDEN</b>			
<b>DATE OF REGISTRATION</b>	10/10/2013		
<b>TITLE</b>	TOY TRUCK		
<b>PRIORITY</b>			
<b>PRIORITY NUMBER</b>	<b>DATE</b>	<b>COUNTRY</b>	
2013/0147	11/04/2013	SWEDEN	
<b>DESIGN NUMBER</b>	258312		
<b>CLASS</b>	07-02		
<b>1)JASH INTERNATIONAL., (AN INDIAN SOLE PROPRIETORSHIP CONCERN), HAVING OFFICE AT SHED NO. DD, KHAN REAL ESTATE COMPOUND, NEAR SAEED FARM, NATIONAL HIGHWAY NO. 8, NEAR VASAI PHATA, VASAI (EAST), DIST-THANE, MAHARASHTRA, INDIA.</b> WHOSE PROPRIETOR IS BHUPENDRA DHAKAD. (INDIAN NATIONAL) OF ABOVE ADDRESS			
<b>DATE OF REGISTRATION</b>	22/11/2013		
<b>TITLE</b>	CASSEROLE		
<b>PRIORITY NA</b>			

<b>DESIGN NUMBER</b>	258186		
<b>CLASS</b>	26-05		
<b>1)PANASONIC CORPORATION, A JAPANESE COMPANY ORGANIZED AND EXISTING UNDER THE LAWS OF JAPAN, OF 1006, OAZA KADOMA, KADOMA-SHI, OSAKA 571-8501, JAPAN</b>			
<b>DATE OF REGISTRATION</b>	18/11/2013		
<b>TITLE</b>	HANGING LIGHT		
<b>PRIORITY</b>			
<b>PRIORITY NUMBER</b>	<b>DATE</b>	<b>COUNTRY</b>	
2013-011101	21/05/2013	JAPAN	
<b>DESIGN NUMBER</b>			
<b>CLASS</b>	12-15		
<b>1)SUMITOMO RUBBER INDUSTRIES LTD. A COMPANY ORGANIZED UNDER THE LAWS OF JAPAN OF THE ADDRESS: 6-9, WAKINOHAMA-CHO 3-CHOME, CHUO-KU, KOBE-SHI, HYOGO 651-0072, JAPAN</b>			
<b>DATE OF REGISTRATION</b>	12/12/2013		
<b>TITLE</b>	TIRE FOR AUTOMOBILE		
<b>PRIORITY</b>			
<b>PRIORITY NUMBER</b>	<b>DATE</b>	<b>COUNTRY</b>	
2013-023451	07/10/2013	JAPAN	
<b>DESIGN NUMBER</b>			
<b>CLASS</b>	24-02		
<b>1)KONINKLIJKE PHILIPS N.V., A COMPANY ORGANIZED AND EXISTING UNDER THE LAWS OF THE KINGDOM OF THE NETHERLANDS, RESIDING AT EINDHOVEN, WHOSE POST-OFFICE ADDRESS IS HIGH TECH CAMPUS 5, 5656 AE EINDHOVEN, THE NETHERLANDS</b>			
<b>DATE OF REGISTRATION</b>	22/11/2013		
<b>TITLE</b>	HUB FOR RESPIRATORY MASK		
<b>PRIORITY</b>			
<b>PRIORITY NUMBER</b>	<b>DATE</b>	<b>COUNTRY</b>	
002255174-0001	13/06/2013	OHIM	

<b>DESIGN NUMBER</b>	258081		
<b>CLASS</b>	23-01		
<b>1)KLAUS WARREN FIXTURES PVT. LTD. OF 285, "PARK VIEW" 1ST FLOOR, FLAT NO. 9, B. A. K. ANJAN MARG, OPP. NAPOO GARDEN, MATUNGA (CENTRAL RAILWAY) (E), MUMBAI-400019, MAHARASHTRA, INDIA, INDIAN COMPANY</b>			
<b>DATE OF REGISTRATION</b>	12/11/2013		
<b>TITLE</b>	BASIN FAUCET		
<b>PRIORITY NA</b>			
<b>DESIGN NUMBER</b>	258187		
<b>CLASS</b>	26-05		
<b>1)PANASONIC CORPORATION, A JAPANESE COMPANY ORGANIZED AND EXISTING UNDER THE LAWS OF JAPAN, OF 1006, OAZA KADOMA, KADOMA-SHI, OSAKA 571-8501, JAPAN</b>			
<b>DATE OF REGISTRATION</b>	18/11/2013		
<b>TITLE</b>	HANGING LIGHT		
<b>PRIORITY</b>			
<b>PRIORITY NUMBER</b>	<b>DATE</b>	<b>COUNTRY</b>	
2013-011102	21/05/2013	JAPAN	
<b>DESIGN NUMBER</b>	254846		
<b>CLASS</b>	24-01		
<b>1)INSULINE MEDICAL LTD. 70 PINKSKER STREET, P.O. BOX 10299, PETACH-TIKVA, POSTAL CODE-49002, ISRAEL, A COMPANY OF ISRAEL</b>			
<b>DATE OF REGISTRATION</b>	27/06/2013		
<b>TITLE</b>	CONTROL UNIT IN DRUG DELIVERY SYSTEM		
<b>PRIORITY</b>			
<b>PRIORITY NUMBER</b>	<b>DATE</b>	<b>COUNTRY</b>	
29/440,941	28/12/2012	U.S.A.	

<b>DESIGN NUMBER</b>	252073		
<b>CLASS</b>	10-04		
<b>1)DIRECTOR GENERAL DEFENCE RESEARCH &amp; DEVELOPMENT ORGANISATION MINISTRY OF DEFENCE, GOVERNMENT OF INDIA, ROOM NO. 348, B-WING, DRDO BHAWAN, RAJAJI MARG, NEW DELHI-110105, INDIA, AN INDIAN ORGANISATION</b>			
<b>DATE OF REGISTRATION</b>	05/03/2013		
<b>TITLE</b>	FREQUENCY COUNTER		
<b>PRIORITY NA</b>			
<b>DESIGN NUMBER</b>	258194		
<b>CLASS</b>	14-02		
<b>1)DWS S.R.L., A LIMITED LIABILITY COMPANY EXISTING UNDER THE LAWS OF ITALY, 36010 ZANE' (VICENZA), VIA LAGO DI LEVICO, 3, ITALY</b>			
<b>DATE OF REGISTRATION</b>	18/11/2013		
<b>TITLE</b>	STEREOLITHOGRAPHY MACHINE		
<b>PRIORITY</b>			
<b>PRIORITY NUMBER</b>	<b>DATE</b>	<b>COUNTRY</b>	
002284133-0001	31/07/2013	EUROPEAN UNION	
<b>DESIGN NUMBER</b>	258905		
<b>CLASS</b>	13-02		
<b>1)MANIKA MOULDS PVT. LTD., A COMPANY INCORPORATED UNDER THE INDIAN COMPANIES ACT, AAR-PEE CENTRE, 601-605, 6TH FLOOR GUFFIC COMPOUND, MIDC, ANDHERI (E), MUMBAI-400093, MAHARASHTRA, INDIA</b>			
<b>DATE OF REGISTRATION</b>	23/12/2013		
<b>TITLE</b>	BATTERY LID		
<b>PRIORITY NA</b>			

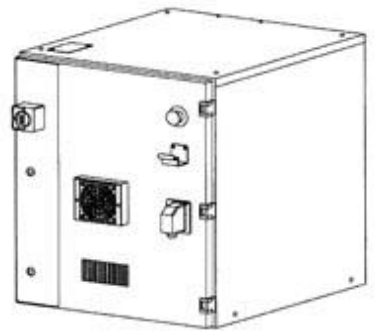

<b>DESIGN NUMBER</b>	257364	
<b>CLASS</b>	07-01	
<b>1)RAVISSANT PRIVATE LIMITED, AN INDIAN COMPANY, OF 50-51, COMMERCIAL COMPLEX, NEW FRIENDS COLONY, NEW DELHI-110065, INDIA</b>		
<b>DATE OF REGISTRATION</b>	09/10/2013	
<b>TITLE</b>	POT	
<b>PRIORITY NA</b>		
<b>DESIGN NUMBER</b>	258398	
<b>CLASS</b>	09-01	
<b>1)M/S FRESH FOOD &amp; BEVERAGES, PLOT NO. 251, SECTOR-27/28, INDUSTRIAL AREA, HISAR, HARYANA, AN INDIAN PARTNERSHIP FIRM, WHOSE PARTNERS ARE (1) ANIL KUMAR (2) VIJAY KUMAR, OF ABOVE ADDRESS, AN INDIAN NATIONAL</b>		
<b>DATE OF REGISTRATION</b>	26/11/2013	
<b>TITLE</b>	BOTTLE	
<b>PRIORITY NA</b>		
<b>DESIGN NUMBER</b>	257531	
<b>CLASS</b>	13-03	
<b>1)KABUSHIKI KAISHA YASKAWA DENKI A JAPANESE COMPANY OF THE ADDRESS: 2-1, KUROSAKI-SHIROISHI, YAHATANISHI-KU, KITAKYUSHU-SHI, FUKUOKA 806-0004, JAPAN</b>		
<b>DATE OF REGISTRATION</b>	15/10/2013	
<b>TITLE</b>	ROBOT CONTROLLER	
<b>PRIORITY</b>		
<b>PRIORITY NUMBER</b>	<b>DATE</b>	<b>COUNTRY</b>
2013-17547	31/07/2013	JAPAN







<b>DESIGN NUMBER</b>	256591	
<b>CLASS</b>	09-01	
<b>1) MASTER WARE PLAST PRIVATE LIMITED, A COMPANY INCORPORATION UNDER THE COMPANIES ACT, 1956, HAVING PRINCIPAL PLACE OF BUSINESS AT</b> 230, SARAJJIVINAGAR, NEAR SHAKRIBA PARTY PLOT, C. T. M., AMRAIWADI, AHMEDABAD-380026, GUJARAT STATE, INDIA		
<b>DATE OF REGISTRATION</b>	19/09/2013	
<b>TITLE</b>	BOTTLE	
<b>PRIORITY NA</b>		
<b>DESIGN NUMBER</b>	249320	
<b>CLASS</b>	09-99	
<b>1) TOPLAND ENGINES PVT. LTD. (A COMPANY INCORPORATED UNDER THE COMPANIES ACT, 1956) HAVING ITS REGISTERED OFFICE AT</b> 2, UMAKANT PANDIT, UDYOGNAGAR, MAVDI PLOT, RAJKOT-360004 (GUJARAT), INDIA, INDIAN COMPANY		
<b>DATE OF REGISTRATION</b>	08/11/2012	
<b>TITLE</b>	FRAME FOR TRANSPORTATION OF HEAVY PRODUCTS	
<b>PRIORITY NA</b>		
<b>DESIGN NUMBER</b>	257894	
<b>CLASS</b>	23-01	
<b>1) DAYAL CHAND TRADING AS M/S. SIGMA REFRIGERATION WORKS,</b> 3745, SHOP NO. 1 & 7, KUCHA PARMANAND, NETAJI SUBHASH MARG, DARYA GANJ, NEW DELHI-110002, INDIA (A SOLE PROPRIETORSHIP FIRM)		
<b>DATE OF REGISTRATION</b>	31/10/2013	
<b>TITLE</b>	WATER FLOW CONTROL SWITCH	
<b>PRIORITY NA</b>		

<b>DESIGN NUMBER</b>	259861	
<b>CLASS</b>	06-01	
<b>1)NATIONAL PLASTO PRODUCTS PRIVATE LIMITED, AN INDIAN COMPANY HAVING ITS REGISTERED OFFICE AT 19, SUKEAS LANE, 1ST FLOOR, KOLKATA 700001, WEST BENGAL, INDIA</b>		
<b>DATE OF REGISTRATION</b>	30/01/2014	
<b>TITLE</b>	CHAIR	
<b>PRIORITY NA</b>		
<b>DESIGN NUMBER</b>	258205	
<b>CLASS</b>	13-03	
<b>1)CHAMPALAL (PROPRIETOR), NATIONALITY INDIAN TRADING AS SRI RAM DEV AGENCIES (THIS IS SOLE PROPRIETORSHIP CONCERN) WHOSE ADDRESS IS 223/4, GALI NO. 8, PADAM NAGAR, DELHI-110007</b>		
<b>DATE OF REGISTRATION</b>	18/11/2013	
<b>TITLE</b>	SWITCH FOR INDUSTRIAL USE	
<b>PRIORITY NA</b>		
<b>DESIGN NUMBER</b>	254905	
<b>CLASS</b>	06-08	
<b>1)DAMJIBHAI LAXMANBHAI SORATHIYA (ADULT &amp; INDIAN NATIONAL) PROPRIETOR OF NEW RAMESHWAR ENTERPRISE (INDIAN PROPRIETORSHIP CONCERN) HAVING PLACE OF BUSINESS AT -7, PATEL NAGAR, 80 FEET MAIN ROAD, RAJKOT-360 002- GUJARAT (INDIA)</b>		
<b>DATE OF REGISTRATION</b>	02/07/2013	
<b>TITLE</b>	CLOTHES HANGER	
<b>PRIORITY NA</b>		

<b>DESIGN NUMBER</b>	256757		
<b>CLASS</b>	24-01		
<b>1)KONINKLIJKE PHILIPS N.V., A COMPANY ORGANIZED AND EXISTING UNDER THE LAWS OF THE KINGDOM OF THE NETHERLANDS, RESIDING AT EINDHOVEN,</b> WHOSE POST-OFFICE ADDRESS IS HIGH TECH CAMPUS 5, 5656 AE EINDHOVEN, THE NETHERLANDS			
<b>DATE OF REGISTRATION</b>	25/09/2013		
<b>TITLE</b>	STERILIZER		
<b>PRIORITY</b>			
<b>PRIORITY NUMBER</b>	<b>DATE</b>	<b>COUNTRY</b>	
002225292-0001	23/04/2013	OHIM	
<b>DESIGN NUMBER</b>	259859		
<b>CLASS</b>	06-01		
<b>1)NATIONAL PLASTO PRODUCTS PRIVATE LIMITED, AN INDIAN COMPANY HAVING ITS REGISTERED OFFICE AT</b> 19, SUKEAS LANE, 1ST FLOOR, KOLKATA 700001, WEST BENGAL, INDIA			
<b>DATE OF REGISTRATION</b>	30/01/2014		
<b>TITLE</b>	CHAIR		
<b>PRIORITY NA</b>			
<b>DESIGN NUMBER</b>	257366		
<b>CLASS</b>	07-01		
<b>1)RAVISSANT PRIVATE LIMITED, AN INDIAN COMPANY, OF</b> 50-51, COMMERCIAL COMPLEX, NEW FRIENDS COLONY, NEW DELHI-110065, INDIA			
<b>DATE OF REGISTRATION</b>	09/10/2013		
<b>TITLE</b>	POT		
<b>PRIORITY NA</b>			

<b>DESIGN NUMBER</b>	256594	
<b>CLASS</b>	23-04	
<b>1)SMIT NAVNITLAL PARMAR, INDIAN NATIONALITY, A SOLE PROPRIETOR OF M/S. JUGAL HANSAL BROTHERS, AN INDIAN SOLE PROPRIETARY FIRM, HAVING PRINCIPAL PLACE OF BUSINESS AT L/2, MURLIDHAR COMPLEX, S.M. ROAD, AMBAWADI, AHMEDABAD-380015, GUJARAT STATE, INDIA</b>		
<b>DATE OF REGISTRATION</b>	19/09/2013	
<b>TITLE</b>	AIR CONDITIONER	
<b>PRIORITY NA</b>		

<b>DESIGN NUMBER</b>	257899	
<b>CLASS</b>	23-01	
<b>1)DAYAL CHAND TRADING AS M/S. SIGMA REFRIGERATION WORKS, 3745, SHOP NO. 1 &amp; 7, KUCHA PARMANAND, NETAJI SUBHASH MARG, DARYA GANJ, NEW DELHI-110002, INDIA (A SOLE PROPRIETORSHIP FIRM)</b>		
<b>DATE OF REGISTRATION</b>	31/10/2013	
<b>TITLE</b>	SOLENOID VALVE	
<b>PRIORITY NA</b>		

<b>DESIGN NUMBER</b>	254248	
<b>CLASS</b>	12-16	
<b>1)FLEETGUARD FILTERS PVT. LTD., A COMPANY INCORPORATED UNDER THE INDIAN COMPANIES ACT, 'KIRLOSKAR HOUSE', 100, ANAND PARK, AUNDH, PUNE-411007, MAHARASHTRA, INDIA.</b>		
<b>DATE OF REGISTRATION</b>	03/06/2013	
<b>TITLE</b>	DUST EJECTOR VALVE	
<b>PRIORITY NA</b>		

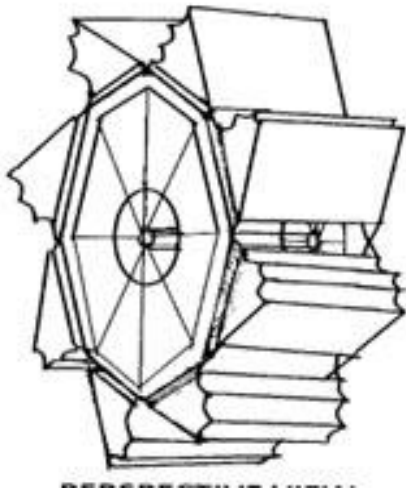
<b>DESIGN NUMBER</b>	255355	
<b>CLASS</b>	15-01	
<b>1)BIBEK NARAYAN NANDI, INDIAN NATIONAL,, A/III/2F, METRO RAILWAY QUARTERS COMPLEX, P-247, DESHAPRAN SHASMAL ROAD, KOLKATA-700033, WEST BENGAL</b>		
<b>DATE OF REGISTRATION</b>	19/07/2013	
<b>TITLE</b>	IMPULSE TURBINE	
<b>PRIORITY NA</b>		

<b>DESIGN NUMBER</b>	257369	
<b>CLASS</b>	07-01	
<b>1)RAVISSANT PRIVATE LIMITED, AN INDIAN COMPANY, OF 50-51, COMMERCIAL COMPLEX, NEW FRIENDS COLONY, NEW DELHI-110065, INDIA</b>		
<b>DATE OF REGISTRATION</b>	09/10/2013	
<b>TITLE</b>	GLASS	
<b>PRIORITY NA</b>		

<b>DESIGN NUMBER</b>	257424	
<b>CLASS</b>	09-01	
<b>1)SUDEEP PLASTICS PVT. LTD., (AN INDIAN PRIVATE LIMITED COMPANY REGISTERED UNDER THE INDIAN COMPANIES ACT, 1956), OF SHOP NO. 3, UNITED CO-OP. HSG. SOC., OPPOSITE RAMESHWAR MANDIR TALAV, RAM NAGAR, BHANDARWALA ROAD, MALAD (WEST), MUMBAI-400064. MAHARASHTRA, INDIA</b>		
<b>DATE OF REGISTRATION</b>	11/10/2013	
<b>TITLE</b>	BOTTLE	
<b>PRIORITY NA</b>		

<b>DESIGN NUMBER</b>	258041	
<b>CLASS</b>	13-03	
<b>1)ABB FRANCE, A COMPANY ORGANIZED UNDER THE LAWS OF FRANCE, OF</b> 3 AVENUE DU CANADA, IMMEUBLE ATHOS, LES ULIS, 91978 COURTABOEUF CEDEX, FRANCE		
<b>DATE OF REGISTRATION</b>	08/11/2013	
<b>TITLE</b>	ELECTRIC CONTACTOR	
<b>PRIORITY</b>		
PRIORITY NUMBER	DATE	COUNTRY
002 287 664	06/08/2013	OHIM

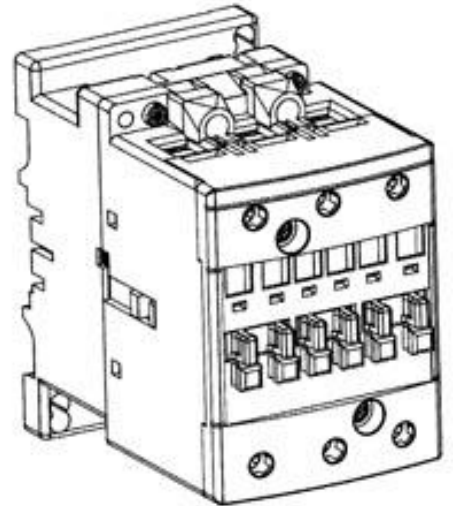

<b>DESIGN NUMBER</b>	257130	
<b>CLASS</b>	14-02	
<b>1)NEC CORPORATION, A JAPANESE COMPANY OF</b> 7-1, SHIBA 5-CHOME, MINATO-KU, TOKYO, JAPAN		
<b>DATE OF REGISTRATION</b>	01/10/2013	
<b>TITLE</b>	FRONT PANEL FOR COMPUTER	
<b>PRIORITY</b>		
PRIORITY NUMBER	DATE	COUNTRY
2013-007442	02/04/2013	JAPAN

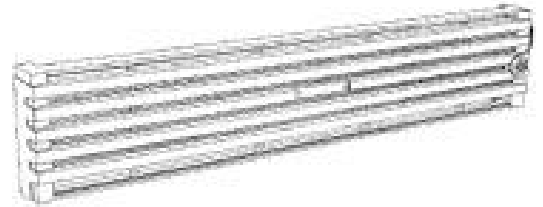

<b>DESIGN NUMBER</b>	258042	
<b>CLASS</b>	13-03	
<b>1)ABB FRANCE, A COMPANY ORGANIZED UNDER THE LAWS OF FRANCE, OF</b> 3 AVENUE DU CANADA, IMMEUBLE ATHOS, LES ULIS, 91978 COURTABOEUF CEDEX, FRANCE		
<b>DATE OF REGISTRATION</b>	08/11/2013	
<b>TITLE</b>	ELECTRIC CONTACTOR	
<b>PRIORITY</b>		
PRIORITY NUMBER	DATE	COUNTRY
002 287 664	06/08/2013	EUROPEAN UNION

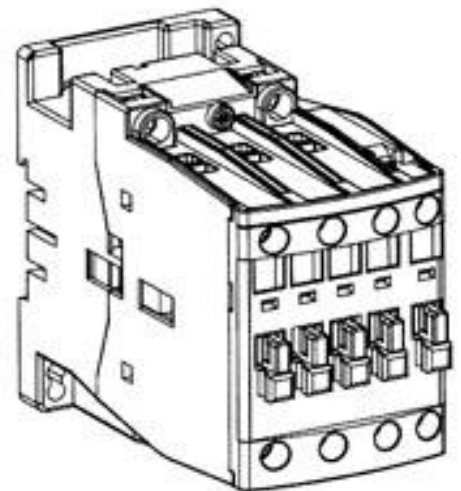

<b>DESIGN NUMBER</b>	254906	
<b>CLASS</b>	06-08	
<b>1)DAMJIBHAI LAXMANBHAI SORATHIYA (ADULT &amp; INDIAN NATIONAL) PROPRIETOR OF NEW RAMESHWAR ENTERPRISE (INDIAN PROPRIETORSHIP CONCERN) HAVING PLACE OF BUSINESS AT -7, PATEL NAGAR, 80 FEET MAIN ROAD, RAJKOT-360 002-GUJARAT (INDIA)</b>		
<b>DATE OF REGISTRATION</b>	02/07/2013	
<b>TITLE</b>	CLOTHES HANGER	
<b>PRIORITY NA</b>		
<b>DESIGN NUMBER</b>	259860	
<b>CLASS</b>	06-01	
<b>1)NATIONAL PLASTO PRODUCTS PRIVATE LIMITED, AN INDIAN COMPANY HAVING ITS REGISTERED OFFICE AT 19, SUKEAS LANE, 1ST FLOOR, KOLKATA 700001, WEST BENGAL, INDIA</b>		
<b>DATE OF REGISTRATION</b>	30/01/2014	
<b>TITLE</b>	CHAIR	
<b>PRIORITY NA</b>		
<b>DESIGN NUMBER</b>	259371	
<b>CLASS</b>	09-03	
<b>1)M/S. SWEETON FOODS PVT. LTD., (A COMPANY DULY INCORPORATED UNDER THE INDIAN COMPANIES ACT, 1956), E-3, SECTOR-1, BAWANA, DELHI-110039</b>		
<b>DATE OF REGISTRATION</b>	13/01/2014	
<b>TITLE</b>	CONTAINER	
<b>PRIORITY NA</b>		

<b>DESIGN NUMBER</b>	255976		
<b>CLASS</b>	23-03		
1)THE ABELL FOUNDATION, INC., A CORPORATION OF MARYLAND, SUITE 2300, 111 S. CALVERT STREET, BALTIMORE, MD 21202-6174			
<b>DATE OF REGISTRATION</b>	22/08/2013		
<b>TITLE</b>	EVAPORATOR HEAT EXCHANGER PLATE		
<b>PRIORITY</b>			
<b>PRIORITY NUMBER</b>	<b>DATE</b>	<b>COUNTRY</b>	
29/442,395	22/02/2013	U.S.A.	
<b>DESIGN NUMBER</b>	254600		
<b>CLASS</b>	04-02		
1)SHREE SIMANDHAR INDUSTRIES IS A PROPRIETORSHIP FIRM OF 21, NEW MANU BHUVAN, BHAGAT SINGH ROAD, VILE PARLE (W), MUMBAI- 400056, MAHARASHTRA, INDIA			
<b>DATE OF REGISTRATION</b>	20/06/2013		
<b>TITLE</b>	HAIR COLOURING BRUSH		
<b>PRIORITY NA</b>			
<b>DESIGN NUMBER</b>	257365		
<b>CLASS</b>	07-01		
1)RAVISSANT PRIVATE LIMITED, AN INDIAN COMPANY, OF 50-51, COMMERCIAL COMPLEX, NEW FRIENDS COLONY, NEW DELHI- 110065, INDIA			
<b>DATE OF REGISTRATION</b>	09/10/2013		
<b>TITLE</b>	DISH		
<b>PRIORITY NA</b>			



<b>DESIGN NUMBER</b>	257560		
<b>CLASS</b>	10-04		
<b>1)JENOPTIK INDUSTRIAL METROLOGY GERMANY GMBH, OF ALTE TUTTLINGER STRAßE 20, 78056 VILLINGEN-SCHWENNINGEN, GERMANY</b>			
<b>DATE OF REGISTRATION</b>	18/10/2013		
<b>TITLE</b>	DEVICE FOR MEASURING ROUGHNESS		
<b>PRIORITY</b>			
<b>PRIORITY NUMBER</b>	<b>DATE</b>	<b>COUNTRY</b>	
40 2013 001 914.6	20/04/2013	GERMANY	
<b>DESIGN NUMBER</b>	256429		
<b>CLASS</b>	12-16		
<b>1)HERO MOTOCORP LIMITED, A COMPANY INCORPORATED UNDER THE INDIAN COMPANIES ACT, HAVING ITS OFFICE AT 34, COMMUNITY CENTRE, BASANT LOK, VASANT VIHAR, NEW DELHI-110057</b>			
<b>DATE OF REGISTRATION</b>	13/09/2013		
<b>TITLE</b>	TAIL LIGHT LENS FOR A TWO WHEELED VEHICLE		
<b>PRIORITY NA</b>			
<b>DESIGN NUMBER</b>	256593		
<b>CLASS</b>	09-01		
<b>1)MASTER WARE PLAST PRIVATE LIMITED, A COMPANY INCORPORATION UNDER THE COMPANIES ACT, 1956, HAVING PRINCIPAL PLACE OF BUSINESS AT 230, SARAMJIVINAGAR, NEAR SHAKRIBA PARTY PLOT, C. T. M., AMRAIWADI, AHMEDABAD-380026, GUJARAT STATE, INDIA</b>			
<b>DATE OF REGISTRATION</b>	19/09/2013		
<b>TITLE</b>	BOTTLE		
<b>PRIORITY NA</b>			

<b>DESIGN NUMBER</b>	257807		
<b>CLASS</b>	13-03		
<b>1)ARUN ENTERPRISES, B-48, SITE-4, INDUSTRIAL AREA, SHAHIBABAD, DIST.-GHAZIABAD-201010, UTTAR PRADESH, INDIA. (AN INDIAN PARTNERSHIP FIRM WHOSE PARTNERS ARE:- SH. C. L. DHIR, SH. ARUN DHIR, SH. TARUN DHIR. AN INDIAN NATIONAL OF THE ABOVE ADDRESS</b>			
<b>DATE OF REGISTRATION</b>	28/10/2013		
<b>TITLE</b>	CONNECTOR FOR ELECTRICAL CABLES		
<b>PRIORITY NA</b>			
<b>DESIGN NUMBER</b>	255004		
<b>CLASS</b>	25-01		
<b>1)ODENWALD FASERPLATTENWERK GMBH, OF DR.-F.-A.-FREUNDT-STRASSE 3, 63916 AMORBACH, GERMANY, A GERMAN COMPANY</b>			
<b>DATE OF REGISTRATION</b>	04/07/2013		
<b>TITLE</b>	CEILING PANEL		
<b>PRIORITY</b>			
<b>PRIORITY NUMBER</b>	<b>DATE</b>	<b>COUNTRY</b>	
711987701	04/01/2013	WIPO	
<b>DESIGN NUMBER</b>	258809		
<b>CLASS</b>	09-03		
<b>1)OILTECH LUBRICANTS PVT. LTD. (A COMPANY INCORPORATED UNDER THE COMPANIES ACT, 1956) HAVING ITS PRINCIPAL PLACE OF BUSINESS AT ADDRESS 504, RAJ CHAMBERS, MANCHHUBHAI ROAD, MALAD (E), MUMBAI-400097, MAHARASHTRA-INDIA</b>			
<b>DATE OF REGISTRATION</b>	17/12/2013		
<b>TITLE</b>	CONTAINER		
<b>PRIORITY NA</b>			

<b>DESIGN NUMBER</b>	257131	
<b>CLASS</b>	14-02	
1)NEC CORPORATION, A JAPANESE COMPANY OF 7-1, SHIBA 5-CHOME, MINATO-KU, TOKYO, JAPAN		
<b>DATE OF REGISTRATION</b>	01/10/2013	
<b>TITLE</b>	FRONT PANEL FOR COMPUTER	
<b>PRIORITY</b>		
PRIORITY NUMBER	DATE	COUNTRY
2013-007444	02/04/2013	JAPAN



<b>DESIGN NUMBER</b>	256070	
<b>CLASS</b>	24-02	
1)VIACYTE, INC, A COMPANY INCORPORATED UNDER THE LAWS OF UNITED STATES OF AMERICA, HAVING ITS ADDRESS AT 3550 GENERAL ATOMICS CT., # 2-503, SAN DIEGO, CALIFORNIA, 92121, U.S.A.		
<b>DATE OF REGISTRATION</b>	27/08/2013	
<b>TITLE</b>	CELL ENCAPSULATION DEVICE	
<b>PRIORITY</b>		
PRIORITY NUMBER	DATE	COUNTRY
29/447,944	07/03/2013	U.S.A.

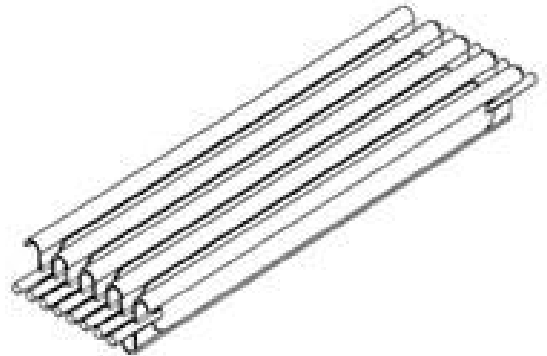

<b>DESIGN NUMBER</b>	254802	
<b>CLASS</b>	23-01	
1)TOYOX CO., LTD. 4371, MAEZAWA, KUROBE-SHI, TOYAMA-KEN, JAPAN A JAPANESE COMPANY		
<b>DATE OF REGISTRATION</b>	25/06/2013	
<b>TITLE</b>	HOSE	
<b>PRIORITY NA</b>		



<b>DESIGN NUMBER</b>	258043	
<b>CLASS</b>	13-03	
1)ABB FRANCE, A COMPANY ORGANIZED UNDER THE LAWS OF FRANCE, OF 3 AVENUE DU CANADA, IMMEUBLE ATHOS, LES ULIS, 91978 COURTABOEUF CEDEX, FRANCE		
<b>DATE OF REGISTRATION</b>	08/11/2013	
<b>TITLE</b>	ELECTRIC CONTACTOR	
<b>PRIORITY</b>		
<b>PRIORITY NUMBER</b>	<b>DATE</b>	<b>COUNTRY</b>
002 287 664	06/08/2013	OHIM

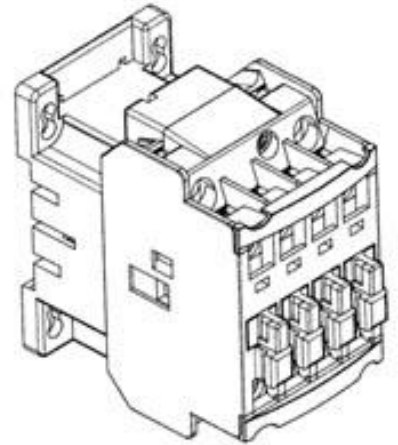



<b>DESIGN NUMBER</b>	257865	
<b>CLASS</b>	06-05	
1)HAWORTH, INC., ONE HAWORTH CENTER, HOLLAND, MICHIGAN 49423, UNITED STATES OF AMERICA, A MICHIGAN CORPORATION		
<b>DATE OF REGISTRATION</b>	29/10/2013	
<b>TITLE</b>	CHAIR ATTACHED WITH WORK SURFACE	
<b>PRIORITY</b>		
<b>PRIORITY NUMBER</b>	<b>DATE</b>	<b>COUNTRY</b>
29/453,397	29/04/2013	U.S.A.



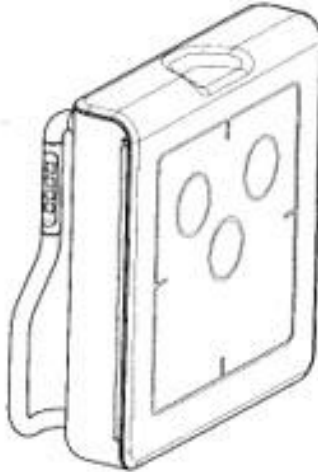

<b>DESIGN NUMBER</b>	254847	
<b>CLASS</b>	24-01	
1)INSULINE MEDICAL LTD. 70 PINKSKER STREET, P.O. BOX 10299, PETACH-TIKVA, POSTAL CODE-49002, ISRAEL, A COMPANY OF ISRAEL		
<b>DATE OF REGISTRATION</b>	27/06/2013	
<b>TITLE</b>	INJECTION WINDOW IN DRUG DELIVERY SYSTEM	
<b>PRIORITY</b>		
<b>PRIORITY NUMBER</b>	<b>DATE</b>	<b>COUNTRY</b>
29/440,941	28/12/2012	U.S.A.



<b>DESIGN NUMBER</b>	258792		
<b>CLASS</b>	09-01		
<b>1)BULGARI S.P.A. (A COMPANY ORGANIZED AND EXISTING UNDER THE LAWS OF ITALY) OF THE ADDRESS</b> LUNGOTEVERE MARZIO, 11, I-00186 ROMA, ITALY			
<b>DATE OF REGISTRATION</b>	17/12/2013		
<b>TITLE</b>	PERFUME BOTTLE		
<b>PRIORITY</b>			
<b>PRIORITY NUMBER</b>	<b>DATE</b>	<b>COUNTRY</b>	
760836001	10/09/2013	WIPO	
<b>DESIGN NUMBER</b>			
<b>CLASS</b>	258843		
<b>CLASS</b>	11-01		
<b>1)BULGARI S.P.A. (A COMPANY ORGANIZED AND EXISTING UNDER THE LAWS OF ITALY) OF THE ADDRESS</b> LUNGOTEVERE MARZIO, 11, I-00186 ROMA, ITALY			
<b>DATE OF REGISTRATION</b>	18/12/2013		
<b>TITLE</b>	JEWELLERY SET		
<b>PRIORITY</b>			
<b>PRIORITY NUMBER</b>	<b>DATE</b>	<b>COUNTRY</b>	
745218901	19/06/2013	WIPO	
<b>DESIGN NUMBER</b>			
<b>CLASS</b>	258392		
<b>CLASS</b>	24-02		
<b>1)KONINKLIJKE PHILIPS N.V., A COMPANY ORGANIZED AND EXISTING UNDER THE LAWS OF THE KINGDOM OF THE NETHERLANDS, RESIDING AT EINDHOVEN,</b> WHOSE POST-OFFICE ADDRESS IS HIGH TECH CAMPUS 5, 5656 AE EINDHOVEN, THE NETHERLANDS			
<b>DATE OF REGISTRATION</b>	26/11/2013		
<b>TITLE</b>	CARRIER FOR DETECTOR FOR MEDICAL PURPOSES		
<b>PRIORITY</b>			
<b>PRIORITY NUMBER</b>	<b>DATE</b>	<b>COUNTRY</b>	
002262014-0001	25/06/2013	OHIM	

<b>DESIGN NUMBER</b>	258490	
<b>CLASS</b>	01-01	
1)MR. SUDHANSHU MAKKAR AN INDIAN NATIONAL, TRADING AS M/S. ALISHA CHOCOLATE WORLD PACKAGING CO., C-6, SECTOR-4, BAWANA, DELHI-110039		
<b>DATE OF REGISTRATION</b>	29/11/2013	
<b>TITLE</b>	CHOCOLATE	
<b>PRIORITY NA</b>		

<b>DESIGN NUMBER</b>	258850	
<b>CLASS</b>	08-06	
1)RASIKLAL GHUSABHAI CHOVIYA (ADULT & INDIAN NATIONAL) SOLE PROPRIETOR OF M K TECHNOCAST (INDIAN PROPRIETORSHIP CONCERN) HAVING PLACE OF BUSINESS AT- 2, PATEL NAGAR, SADBHAVNA, PLOT, NR: BHAGWATI ENTERPRISE, 50, FEET MAIN ROAD, RAJKOT-GUJARAT-(INDIA)		
<b>DATE OF REGISTRATION</b>	19/12/2013	
<b>TITLE</b>	HANDLE	
<b>PRIORITY NA</b>		

<b>DESIGN NUMBER</b>	255971	
<b>CLASS</b>	14-03	
1)SAMSUNG ELECTRONICS CO., LTD., A KOREAN COMPANY, OF 129, SAMSUNG-RO, YEONGTONG-GU, SUWON-SI, GYEONGGI-DO, 443-742, REPUBLIC OF KOREA		
<b>DATE OF REGISTRATION</b>	22/08/2013	
<b>TITLE</b>	PORTABLE MOBILE PHONE	
<b>PRIORITY</b>		
<b>PRIORITY NUMBER</b>	<b>DATE</b>	<b>COUNTRY</b>
30-2013-0009585	23/02/2013	KOREA(SOUTH)

<b>DESIGN NUMBER</b>	257363	
<b>CLASS</b>	07-01	
<b>1)RAVISSANT PRIVATE LIMITED, AN INDIAN COMPANY, OF 50-51, COMMERCIAL COMPLEX, NEW FRIENDS COLONY, NEW DELHI-110065, INDIA</b>		
<b>DATE OF REGISTRATION</b>	09/10/2013	
<b>TITLE</b>	POT	
<b>PRIORITY NA</b>		

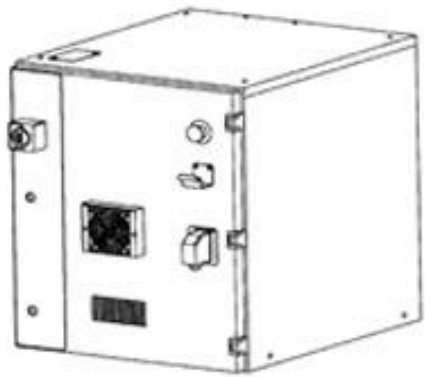
<b>DESIGN NUMBER</b>	257530		
<b>CLASS</b>	13-03		
<b>1)KABUSHIKI KAISHA YASKAWA DENKI A JAPANESE COMPANY OF THE ADDRESS: 2-1, KUROSAKI-SHIROISHI, YAHATANISHI-KU, KITAKYUSHU-SHI, FUKUOKA 806-0004, JAPAN</b>			
<b>DATE OF REGISTRATION</b>	15/10/2013		
<b>TITLE</b>	ROBOT CONTROLLER		
<b>PRIORITY</b>			
<b>PRIORITY NUMBER</b>	<b>DATE</b>	<b>COUNTRY</b>	
2013-17546	31/07/2013	JAPAN	

<b>DESIGN NUMBER</b>	256549		
<b>CLASS</b>	06-05		
<b>1)GODREJ &amp; BOYCE MFG. CO. LTD., AN INDIAN COMPANY INCORPORATED UNDER THE COMPANIES ACT 1913, OF GODREJ INTERIO, PLANT 4, PIROJSHANAGER, VIKHROLI (WEST), MUMBAI-400079, INDIA</b>			
<b>DATE OF REGISTRATION</b>	17/09/2013		
<b>TITLE</b>	COMPOSITE FURNITURE FOR LABORATORY		
<b>PRIORITY NA</b>			

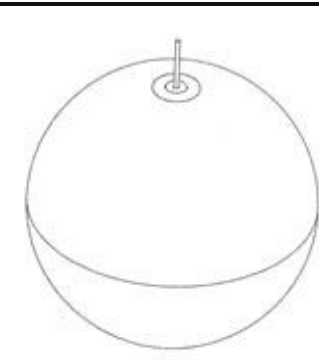
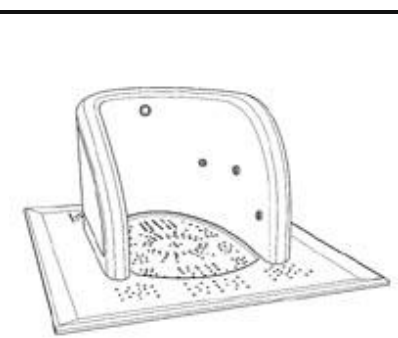
<b>DESIGN NUMBER</b>	258131			
<b>CLASS</b>	10-02			
<b>1)M/S FOLLI FOLLIE COMMERCIAL MANUFACTURING AND TECHNICAL (SOCIETE ANONYME) [A COMPANY ORGANIZED UNDER THE LAWS OF GREECE],</b> 23RD KM ATHENS LAMIA HIGHWAY, 14565 AGIOS STEFANOS, GREECE				
<b>DATE OF REGISTRATION</b>	13/11/2013			
<b>TITLE</b>	WATCH			
<b>PRIORITY</b>				
<b>PRIORITY NUMBER</b>	<b>DATE</b>	<b>COUNTRY</b>		
<b>DESIGN NUMBER</b>	257151			
<b>CLASS</b>	26-05			
<b>1)FLOS S.P.A., AN ITALIAN COMPANY,</b> VIA A. FAINI, 2, I-25073 BOVEZZO, BRESCIA, ITALY				
<b>DATE OF REGISTRATION</b>	01/10/2013			
<b>TITLE</b>	SUSPENSION LAMP			
<b>PRIORITY</b>				
<b>PRIORITY NUMBER</b>	<b>DATE</b>	<b>COUNTRY</b>		
BS2013O000015	08/04/2013	ITALY		
<b>DESIGN NUMBER</b>	259421			
<b>CLASS</b>	23-02			
<b>1)BOLD INTERNATIONAL FZCO, A COMPANY ORGANIZED AND EXISTING UNDER THE LAWS OF UNITED ARAB EMIRATES, HAVING PLACE OF BUSINESS AT</b> PO BOX 261691 JAFZA, DUBAI, UNITED ARAB EMIRATES				
<b>DATE OF REGISTRATION</b>	15/01/2014			
<b>TITLE</b>	FOOT WASHER			
<b>PRIORITY</b>				
<b>PRIORITY NUMBER</b>	<b>DATE</b>	<b>COUNTRY</b>		
001380877-0001	13/08/2013	OHIM		



<b>DESIGN NUMBER</b>	257970		
<b>CLASS</b>	09-01		
1)BONJOUR INTERNATIONAL, A INDIAN PARTNERSHIP FIRM OF 15 UA JAWAHAR NAGAR, DELHI-110007, INDIA, WHOSE PARTNERS ARE (1) RAMAN GUPTA OF 385, DEEPALI, PITAMPURA, DELHI-110034 (2) RAJESH KUMAR GUPTA OF 384, DEEPALI, PITAMPURA, DELHI-110034 AND (3) REENA GUPTA OF 384, DEEPALI, PITAMPURA, DELHI-110034 ALL INDIAN NATIONALS			
<b>DATE OF REGISTRATION</b>	05/11/2013		
<b>TITLE</b>	BOTTLE		
<b>PRIORITY NA</b>			
<b>DESIGN NUMBER</b>	255005		
<b>CLASS</b>	25-01		
1)ODENWALD FASERPLATTENWERK GMBH, OF DR.-F.-A.-FREUNDT-STRASSE 3, 63916 AMORBACH, GERMANY, A GERMAN COMPANY			
<b>DATE OF REGISTRATION</b>	04/07/2013		
<b>TITLE</b>	CEILING PANEL		
<b>PRIORITY</b>			
<b>PRIORITY NUMBER</b>	<b>DATE</b>	<b>COUNTRY</b>	
711987701	04/01/2013	WIPO	
<b>DESIGN NUMBER</b>	257149		
<b>CLASS</b>	26-05		
1)FLOS S.P.A., AN ITALIAN COMPANY, VIA A. FAINI, 2, I-25073 BOVEZZO, BRESCIA, ITALY			
<b>DATE OF REGISTRATION</b>	01/10/2013		
<b>TITLE</b>	TABLE LAMP		
<b>PRIORITY</b>			
<b>PRIORITY NUMBER</b>	<b>DATE</b>	<b>COUNTRY</b>	
BS2013O000015	08/04/2013	ITALY	

<b>DESIGN NUMBER</b>	256253	
<b>CLASS</b>	06-01	
<b>1)MUKUL GOYAL OF DESIGNWISE INDIA PVT. LTD., AN INDIAN NATIONAL, REGISTERED OFFICE- C-34, NEETI BAGH, NEW DELHI-110049, INDIA</b>		
<b>DATE OF REGISTRATION</b>	06/09/2013	
<b>TITLE</b>	CHAIR	
<b>PRIORITY NA</b>		
<b>DESIGN NUMBER</b>	256496	
<b>CLASS</b>	26-02	
<b>1)TATA POWER SOLAR SYSTEMS LIMITED, 78, ELECTRONICS CITY, PHASE I, HOSUR ROAD, BANGALORE 560100, INDIA</b>		
<b>DATE OF REGISTRATION</b>	16/09/2013	
<b>TITLE</b>	SOLAR LANTERN	
<b>PRIORITY NA</b>		
<b>DESIGN NUMBER</b>	255692	
<b>CLASS</b>	12-11	
<b>1)HERO CYCLES LIMITED, HERO NAGAR, G. T. ROAD, LUDHIANA-141003 (PUNJAB), INDIA, (AN INDIAN COMPANY DULY INCORPORATED UNDER THE PROVISIONS OF INDIAN COMPANIES ACT, 1956)</b>		
<b>DATE OF REGISTRATION</b>	06/08/2013	
<b>TITLE</b>	BICYCLE	
<b>PRIORITY NA</b>		

<b>DESIGN NUMBER</b>	257978		
<b>CLASS</b>	23-04		
<b>1)DAYAL CHAND TRADING AS M/S. SIGMA REFRIGERATION WORKS, 3745, SHOP NO. 1 &amp; 7, KUCHA PARMANAND, NETAJI SUBHASH MARG, DARYA GANJ, NEW DELHI-110 002, INDIA (A SOLE PROPRIETORSHIP FIRM)</b>			
<b>DATE OF REGISTRATION</b>	06/11/2013		
<b>TITLE</b>	FAN		
<b>PRIORITY NA</b>			
<b>DESIGN NUMBER</b>	258020		
<b>CLASS</b>	26-04		
<b>1)OSRAM GMBH, A GERMAN COMPANY OF MARCEL-BREUER-STRASSE 6, 80807 MÜNCHEN, GERMANY</b>			
<b>DATE OF REGISTRATION</b>	07/11/2013		
<b>TITLE</b>	LED LIGHT FIXTURE		
<b>PRIORITY</b>			
<b>PRIORITY NUMBER</b>	<b>DATE</b>	<b>COUNTRY</b>	
002236976	14/05/2013	OHIM	
<b>DESIGN NUMBER</b>	258875		
<b>CLASS</b>	08-06		
<b>1)PADMA TRADERS., (AN INDIAN SOLE PROPRIETORSHIP CONCERN), HAVING OFFICE AT 404, VEER GURUKRUPA PREMISES CHS, 1ST CARTER ROAD, NEAR ABHUDAYA BANK, BORIVALI (EAST), MUMBAI-400066, MAHARASHTRA, INDIA. WHOSE PROPRIETOR IS VIKAS JAIN. (INDIAN NATIONAL) OF ABOVE ADDRESS</b>			
<b>DATE OF REGISTRATION</b>	19/12/2013		
<b>TITLE</b>	HANDLE		
<b>PRIORITY NA</b>			

<b>DESIGN NUMBER</b>	257150	
<b>CLASS</b>	26-05	
1)FLOS S.P.A., AN ITALIAN COMPANY, VIA A. FAINI, 2, I-25073 BOVEZZO, BRESCIA, ITALY		
<b>DATE OF REGISTRATION</b>	01/10/2013	
<b>TITLE</b>	SUSPENSION LAMP	
<b>PRIORITY</b>		
PRIORITY NUMBER	DATE	COUNTRY
BS2013O000015	08/04/2013	ITALY



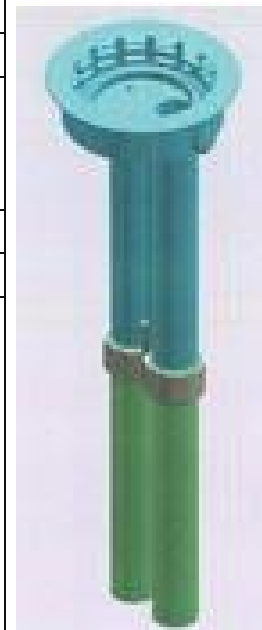

<b>DESIGN NUMBER</b>	257470	
<b>CLASS</b>	31-00	
1)NINGBO SHUANGLIN INDUSTRIAL PRODUCTS MANUFACTURING CO., LTD, NATIONALITY: CHINA, ADDRESS AT NO. 17 SHIFANG INDUSTRIAL PARK, XIDIAN TOWN, NINGHAI CITY, ZHEJIANG PROVINCE, P.R. CHINA		
<b>DATE OF REGISTRATION</b>	14/10/2013	
<b>TITLE</b>	TAP NOZZLE FOR BEVERAGE DISPENSER	
<b>PRIORITY</b>		
PRIORITY NUMBER	DATE	COUNTRY
CN201330338033.3	18/07/2013	CHINA



<b>DESIGN NUMBER</b>	255693	
<b>CLASS</b>	12-11	
1)HERO CYCLES LIMITED, HERO NAGAR, G. T. ROAD, LUDHIANA- 141003 (PUNJAB), INDIA, (AN INDIAN COMPANY DULY INCORPORATED UNDER THE PROVISIONS OF INDIAN COMPANIES ACT, 1956)		
<b>DATE OF REGISTRATION</b>	06/08/2013	
<b>TITLE</b>	BICYCLE	
<b>PRIORITY NA</b>		



<b>DESIGN NUMBER</b>	258793		
<b>CLASS</b>	09-01		
<b>1)BULGARI S.P.A. (A COMPANY ORGANIZED AND EXISTING UNDER THE LAWS OF ITALY) OF THE ADDRESS</b> LUNGOTEVERE MARZIO, 11, I-00186 ROMA, ITALY			
<b>DATE OF REGISTRATION</b>	17/12/2013		
<b>TITLE</b>	PERFUME BOTTLE		
<b>PRIORITY</b>			
<b>PRIORITY NUMBER</b>	<b>DATE</b>	<b>COUNTRY</b>	
760836001	10/09/2013	WIPO	

<b>DESIGN NUMBER</b>	256694		
<b>CLASS</b>	07-01		
<b>1)MRS. SIMPLE (PROPRIETOR), NATIONALITY INDIAN TRADING AS TULIP INDUSTRIES (THIS IS A PROPRIETORSHIP FIRM) WHOES ADDRESS IS</b> C-130, SECTOR-3, BAWANA INDUSTRIAL AREA, DELHI-110039 (INDIA)			
<b>DATE OF REGISTRATION</b>	24/09/2013		
<b>TITLE</b>	PLATE		
<b>PRIORITY NA</b>			

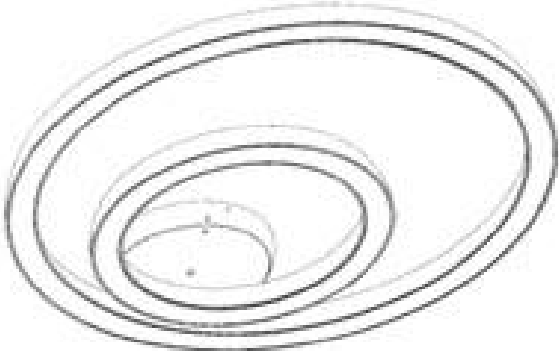
<b>DESIGN NUMBER</b>	256212		
<b>CLASS</b>	26-05		
<b>1)KONINKLIJKE PHILIPS N.V., A COMPANY ORGANIZED AND EXISTING UNDER THE LAWS OF THE KINGDOM OF THE NETHERLANDS, RESIDING AT EINDHOVEN,</b> WHOSE POST-OFFICE ADDRESS IS HIGH TECH CAMPUS 5, 5656 AE EINDHOVEN, THE NETHERLANDS			
<b>DATE OF REGISTRATION</b>	04/09/2013		
<b>TITLE</b>	CEILING LAMP		
<b>PRIORITY</b>			
<b>PRIORITY NUMBER</b>	<b>DATE</b>	<b>COUNTRY</b>	
002200154-0001	11/03/2013	OHIM	

<b>DESIGN NUMBER</b>	249462	
<b>CLASS</b>	14-02	
<b>1)APPLE INC., 1 INFINITE LOOP, CUPERTINO, CA 95014, U.S.A., A CORPORATION INCORPORATED IN THE STATE OF CALIFORNIA</b>		
<b>DATE OF REGISTRATION</b>	14/11/2012	
<b>TITLE</b>	PORTABLE COMPUTER	
<b>PRIORITY</b>		
<b>PRIORITY NUMBER</b>	<b>DATE</b>	<b>COUNTRY</b>
29/420,873	14/05/2012	U.S.A.

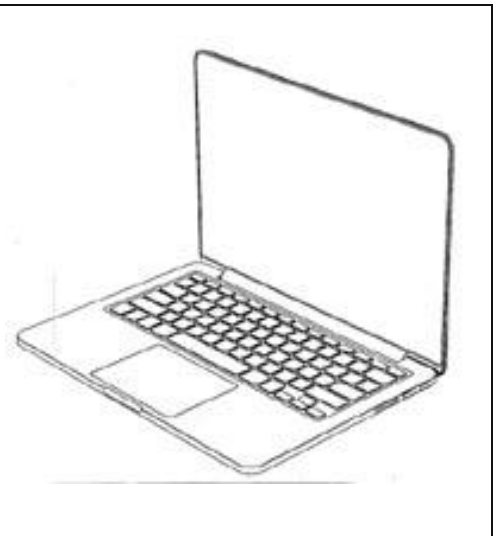

<b>DESIGN NUMBER</b>	257361	
<b>CLASS</b>	07-01	
<b>1)RAVISSANT PRIVATE LIMITED, AN INDIAN COMPANY, OF 50-51, COMMERCIAL COMPLEX, NEW FRIENDS COLONY, NEW DELHI- 110065, INDIA</b>		
<b>DATE OF REGISTRATION</b>	09/10/2013	
<b>TITLE</b>	TEA POT	
<b>PRIORITY NA</b>		



<b>DESIGN NUMBER</b>	258354	
<b>CLASS</b>	09-03	
<b>1)SHRI MAA DISTRIBUTIONS INDIA PVT. LTD., AN INDIAN COMPANY INCORPORATED UNDER THE INDIAN COMPANIES ACT, 1956, HAVING ITS ADDRESS AT 1107, HEMKUNT HOUSE, 6 RAJENDRA PLACE, DELHI-110008, INDIA</b>		
<b>DATE OF REGISTRATION</b>	25/11/2013	
<b>TITLE</b>	CHOCOLATE PACKAGING BOX	
<b>PRIORITY NA</b>		



<b>DESIGN NUMBER</b>	256548
<b>CLASS</b>	06-05
<b>1)GODREJ &amp; BOYCE MFG. CO. LTD., AN INDIAN COMPANY INCORPORATED UNDER THE COMPANIES ACT 1913, OF GODREJ INTERIO, PLANT 4, PIROJSHANAGER, VIKHROLI (WEST), MUMBAI-400079, INDIA</b>	
<b>DATE OF REGISTRATION</b>	17/09/2013
<b>TITLE</b>	COMPOSITE FURNITURE FOR LABORATORY
<b>PRIORITY NA</b>	



<b>DESIGN NUMBER</b>	257529	
<b>CLASS</b>	13-03	
<b>1)KABUSHIKI KAISHA YASKAWA DENKI A JAPANESE COMPANY OF THE ADDRESS: 2-1, KUROSAKI-SHIROISHI, YAHATANISHI-KU, KITAKYUSHU-SHI, FUKUOKA 806-0004, JAPAN</b>		
<b>DATE OF REGISTRATION</b>	15/10/2013	
<b>TITLE</b>	ROBOT CONTROLLER	
<b>PRIORITY</b>		
<b>PRIORITY NUMBER</b>	<b>DATE</b>	<b>COUNTRY</b>
2013-17545	31/07/2013	JAPAN

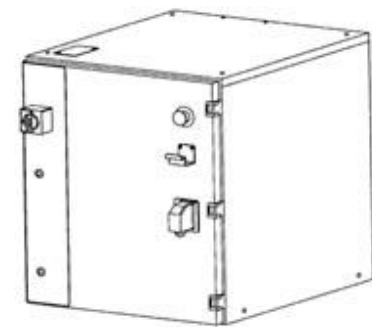

<b>DESIGN NUMBER</b>	257323	
<b>CLASS</b>	15-09	
<b>1)SMC KABUSHIKI KAISHA, A JAPANESE CORPORATION OF 4-14-1, SOTOKANDA, CHIYODA-KU, TOKYO 101-0021, JAPAN</b>		
<b>DATE OF REGISTRATION</b>	09/10/2013	
<b>TITLE</b>	CLAMPING DEVICE FOR SECURING A WORKPIECE	
<b>PRIORITY</b>		
<b>PRIORITY NUMBER</b>	<b>DATE</b>	<b>COUNTRY</b>
2013-008755	18/04/2013	JAPAN

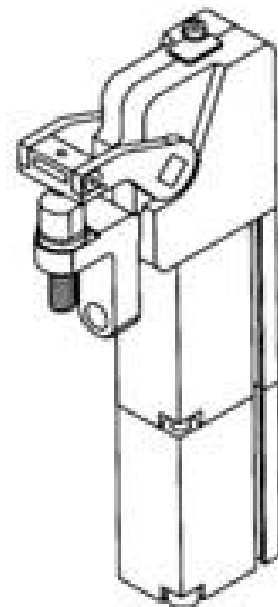

<b>DESIGN NUMBER</b>	256509	
<b>CLASS</b>	15-07	
<b>1)BSH BOSCH UND SIEMENS HAUSGERÄTE GMBH,</b> OF CARL-WERY - STR.34, 81739, MUNICH, GERMANY, A GERMAN COMPANY		
<b>DATE OF REGISTRATION</b>	16/09/2013	
<b>TITLE</b>	REFRIGERATOR	
<b>PRIORITY NA</b>		