

**INTRODUCTION**

In view of the recent amendment made in the Designs (Amendment) Rules, 2008 with effect from 17/06/2008, Publication of the matter relating to Designs is being published in the Official Journal of The Patent Office. This Journal is being published on weekly basis on every Friday covering the various proceedings on Designs as required according to the provisions of under Rule 22, 25, 27 and 39 of the Design (Amendment) Rules, 2008. All the enquiries on this Official Journal and other information as required by the public should be addressed to the Controller General of Patents, Designs & Trade Marks. Suggestions and comments are requested from all quarters so that the content can be enriched.

## COPYRIGHT PUBLICATION

<b>SL NO</b>	<b>REGISTERED DESIGN NUMBERS</b>	<b>RENEWED ON</b>
1.	221876	04.07.2014
2.	221759	04.07.2014
3.	221975	04.07.2014
4.	221974	04.07.2014
5.	250484	04.07.2014
6.	219882	04.07.2014
7.	218825	04.07.2014
8.	219848	04.07.2014
9.	221529	04.07.2014
10.	217436	04.07.2014
11.	217214	04.07.2014
12.	217547	04.07.2014
13.	218109	04.07.2014
14.	218110	04.07.2014
15.	217145	04.07.2014
16.	217215	04.07.2014
17.	217435	04.07.2014
18.	217518	04.07.2014
19.	246815	07.07.2014
20.	220133	07.07.2014
21.	221729	07.07.2014
22.	221727	07.07.2014
23.	221728	07.07.2014
24.	233189	07.07.2014
25.	250145	07.07.2014
26.	250144	07.07.2014
27.	233258	07.07.2014
28.	233190	07.07.2014



**THE DESIGNS ACT 2000**  
**SECTION 30**  
**DESIGN ASSIGNMENT**

The Design stands in the name of ABB AB registered under the Designs Act, 2000 has been assigned in the Register of Designs in the name as follows:-

<b>Design No.</b>	<b>Class</b>	<b>Name</b>
<b>221565</b>	<b>13-01</b>	ABB TECHNOLOGY LTD. OF AFFOLTERNSTRASSE 44, CH-8050 ZURICH, SWITZERLAND

## REGISTRATION OF DESIGNS

The following designs have been registered. They are now open for public inspection. In the following each entry the Date of Registration is shown. The Priority Number, Priority Date and Priority Country are also shown

<b>DESIGN NUMBER</b>	256822			
<b>CLASS</b>	07-06			
<b>1) PEGASUS TRADING AS, NORDRE RØRÅSEN 4, N-3720 SKIEN, NORWAY, NATIONALITY: NORWAY</b>				
<b>DATE OF REGISTRATION</b>	26/09/2013			
<b>TITLE</b>	CAKE SERVER			
<b>PRIORITY</b>				
<b>PRIORITY NUMBER</b>	<b>DATE</b>	<b>COUNTRY</b>		
20130362	17/04/2013	NORWAY		
<b>PRIORITY NA</b>				
<b>PRIORITY NA</b>				
<b>DESIGN NUMBER</b>	258375			
<b>CLASS</b>	13-03			
<b>1) M/S. CONNECTWELL INDUSTRIES PVT. LTD, A COMPANY INCORPORATED UNDER THE COMPANIES ACT 1956 IN INDIA AND HAVING ITS REGISTERED ADDRESS AT D-7, PHASE 2, MIDC, DOMBIVLI (E)-421204, MAHARASHTRA, INDIA</b>				
<b>DATE OF REGISTRATION</b>	26/11/2013			
<b>TITLE</b>	PLUG FOR CONNECTING MULTIPLE ELECTRICAL TERMINALS			
<b>PRIORITY NA</b>				
<b>PRIORITY NA</b>				
<b>DESIGN NUMBER</b>	258040			
<b>CLASS</b>	07-02			
<b>1) UNIVERSAL TRADING COMPANY, HAVING ITS ADDRESS AT 205-B; MITHILA APARTMENT, J.B NAGAR, ANDHERI (E), MUMBAI, MAHARASHTRA (INDIA), PIN-400059</b>				
<b>DATE OF REGISTRATION</b>	08/11/2013			
<b>TITLE</b>	CASSEROLE			
<b>PRIORITY NA</b>				
<b>PRIORITY NA</b>				

<b>DESIGN NUMBER</b>	254161	
<b>CLASS</b>	03-01	
<b>1)MOPHIE, INC. A CORPORATION ORGANIZED UNDER THE LAWS OF THE STATES OF CALIFORNIA, UNITED STATES OF AMERICA OF</b> 2850 RED HILL AVENUE, SUITE 128 SANTA ANA, CALIFORNIA, 92705 U.S.A.		
<b>DATE OF REGISTRATION</b>	29/05/2013	
<b>TITLE</b>	UNBANDIED BATTERY CASE FOR A MOBILE DEVICE	
<b>PRIORITY</b>		
<b>PRIORITY NUMBER</b>	<b>DATE</b>	<b>COUNTRY</b>
29/438,697	30/11/2012	U.S.A.



<b>DESIGN NUMBER</b>	258580	
<b>CLASS</b>	07-02	
<b>1)SOCIÉTÉ DES PRODUITS NESTLÉ S.A. A COMPANY INCORPORATED UNDER THE LAWS OF THE SWITZERLAND HAVING ITS REGISTERED OFFICE</b> AT 1800 VEVEY, SWITZERLAND		
<b>DATE OF REGISTRATION</b>	05/12/2013	
<b>TITLE</b>	COFFEE MACHINE	
<b>PRIORITY</b>		
<b>PRIORITY NUMBER</b>	<b>DATE</b>	<b>COUNTRY</b>
139902	07/06/2013	SWITZERLAND





<b>DESIGN NUMBER</b>	255274	
<b>CLASS</b>	07-02	
<b>1)DART INDUSTRIES INC., A CORPORATION FOUNDED UNDER THE LAWS OF DELAWARE, U.S.A.</b> OF 14901 SOUTH ORANGE BLOSSOM TRAIL, ORLANDO, FLORIDA 32837, USA		
<b>DATE OF REGISTRATION</b>	17/07/2013	
<b>TITLE</b>	BOWL	
<b>PRIORITY</b>		
<b>PRIORITY NUMBER</b>	<b>DATE</b>	<b>COUNTRY</b>
29/447,609	05/03/2013	U.S.A.



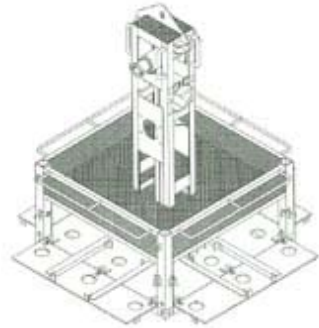
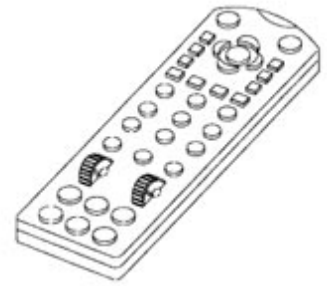

<b>DESIGN NUMBER</b>	256823		
<b>CLASS</b>	07-06		
<b>1)PEGASUS TRADING AS, NORDRE RØRÅSEN 4, N-3720 SKIEN, NORWAY, NATIONALITY: NORWAY</b>			
<b>DATE OF REGISTRATION</b>	26/09/2013		
<b>TITLE</b>	CAKE SERVER		
<b>PRIORITY</b>			
<b>PRIORITY NUMBER</b>	<b>DATE</b>	<b>COUNTRY</b>	
20130361	17/04/2013	NORWAY	
<b>DESIGN NUMBER</b>	259307		
<b>CLASS</b>	24-04		
<b>1)THE PROCTER &amp; GAMBLE COMPANY, A BODY CORPORATE INCORPORATED UNDER THE LAWS OF UNITED STATES OF AMERICA, HAVING ITS REGISTERED OFFICE AT ONE PROCTER &amp; GAMBLE PLAZA, CINCINNATI, OHIO - 45202, UNITED STATES OF AMERICA</b>			
<b>DATE OF REGISTRATION</b>	09/01/2014		
<b>TITLE</b>	SANITARY NAPKIN		
<b>PRIORITY</b>			
<b>PRIORITY NUMBER</b>	<b>DATE</b>	<b>COUNTRY</b>	
750024201	15/07/2013	WIPO	
<b>DESIGN NUMBER</b>	258379		
<b>CLASS</b>	13-01		
<b>1)CROMPTON GREAVES LIMITED, AVANTHA HOUSE, DR. ANNIE BESANT ROAD, WORLI, MUMBAI-400030, MAHARASHTRA, INDIA; AN INDIAN COMPANY</b>			
<b>DATE OF REGISTRATION</b>	26/11/2013		
<b>TITLE</b>	ALTERNATOR		
<b>PRIORITY NA</b>			

<b>DESIGN NUMBER</b>	258729		
<b>CLASS</b>	09-01		
<b>1)HAMILTON HOUSEWARES PVT. LTD. AN INDIAN COMPANY INCORPORATED UNDER THE COMPANIES ACT 1956, HAVING REGISTERED OFFICE AT</b> KAISER-I-HIND BLDG., 3RD FLOOR, CURRIMBHOY ROAD, BALLARD ESTATE, MUMBAI 400001, MAHARASHTRA, INDIA			
<b>DATE OF REGISTRATION</b>	13/12/2013		
<b>TITLE</b>	WATER BOTTLE		
<b>PRIORITY NA</b>			
<b>DESIGN NUMBER</b>	256082		
<b>CLASS</b>	15-99		
<b>1)RELIANCE INDUSTRIES LIMITED, A COMPANY INCORPORATED UNDER THE INDIAN COMPANIES ACT, AT</b> 3RD FLOOR, MAKER CHAMBERS IV, 222, NARIMAN POINT, MUMBAI-400021, MAHARASHTRA, INDIA			
<b>DATE OF REGISTRATION</b>	27/08/2013		
<b>TITLE</b>	TOOL DEPLOYMENT FRAME		
<b>PRIORITY NA</b>			
<b>DESIGN NUMBER</b>	258521		
<b>CLASS</b>	14-03		
<b>1)DANTE R. OLIVAR,</b> 8 DAMA DE NOCHE ST., TOWN & COUNTRY VILLAGE, ANTIPOLLO CITY, PHILIPPINES, A CITIZEN OF PHILIPPINES			
<b>DATE OF REGISTRATION</b>	02/12/2013		
<b>TITLE</b>	REMOTE CONTROLLER FOR ELECTRONIC APPLIANCES		
<b>PRIORITY</b>			
<b>PRIORITY NUMBER</b>	<b>DATE</b>	<b>COUNTRY</b>	
3-2013-000760	25/06/2013	PHILLIPINES	

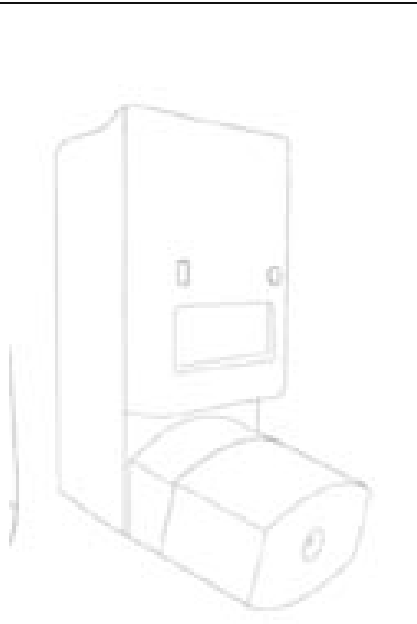

<b>DESIGN NUMBER</b>	255275		
<b>CLASS</b>	07-01		
<b>1)DART INDUSTRIES INC., A CORPORATION FOUNDED UNDER THE LAWS OF DELAWARE, U.S.A. OF 14901 SOUTH ORANGE BLOSSOM TRAIL, ORLANDO, FLORIDA 32837, USA</b>			
<b>DATE OF REGISTRATION</b>	17/07/2013		
<b>TITLE</b>	PLATE		
<b>PRIORITY</b>			
<b>PRIORITY NUMBER</b>	<b>DATE</b>	<b>COUNTRY</b>	
29/447,610	05/03/2013	U.S.A.	
<b>DESIGN NUMBER</b>	256616		
<b>CLASS</b>	12-11		
<b>1)TVS MOTOR COMPANY LIMITED, AN INDIAN COMPANY INCORPORATED UNDER THE COMPANIES ACT, 1956, HAVING ITS REGISTERED OFFICE AT “JAYALAKSHMI ESTATES” , 29 (OLD NO. 8) HADDOWS ROAD, CHENNAI 600006, TAMIL NADU, INDIA</b>			
<b>DATE OF REGISTRATION</b>	19/09/2013		
<b>TITLE</b>	SIDE COVER FOR SCOOTER		
<b>PRIORITY NA</b>			
<b>DESIGN NUMBER</b>	258207		
<b>CLASS</b>	09-01		
<b>1)PRAMIT SANGHAVI AND DEWANG SANGHAVI, PARTNERS TRADING AS V2 CORP., A PARTNERSHIP FIRM, INDIAN, MANUFACTURERS AND MERCHANTS, WHOSE ADDRESS IS WZ-8/1, INDUSTRIAL AREA, KIRTI NAGAR, NEW DELHI-110015, INDIA</b>			
<b>DATE OF REGISTRATION</b>	18/11/2013		
<b>TITLE</b>	BOTTLE		
<b>PRIORITY NA</b>			





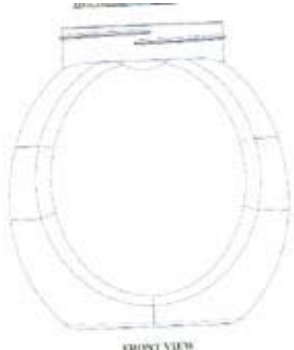

<b>DESIGN NUMBER</b>	258731	
<b>CLASS</b>	24-04	
<b>1)GLENMARK PHARMACEUTICALS LIMITED, AN INDIAN COMPANY REGISTERED UNDER THE COMPANIES ACT, 1956, AND HAVING ITS OFFICE AT</b> GLENMARK HOUSE, HDO - CORPORATE BLDG, WING A, B. D. SAWANT MARG, CHAKALA, ANDHERI (EAST), MUMBAI – 400 099, STATE OF MAHARASHTRA, INDIA		
<b>DATE OF REGISTRATION</b>	13/12/2013	
<b>TITLE</b>	INHALER	
<b>PRIORITY NA</b>		

<b>DESIGN NUMBER</b>	255278	
<b>CLASS</b>	09-07	
<b>1)DART INDUSTRIES INC., A CORPORATION FOUNDED UNDER THE LAWS OF DELAWARE, U.S.A.</b> OF 14901 SOUTH ORANGE BLOSSOM TRAIL, ORLANDO, FLORIDA 32837, USA		
<b>DATE OF REGISTRATION</b>	17/07/2013	
<b>TITLE</b>	LIF OF FOOD CONTAINER	
<b>PRIORITY</b>		
<b>PRIORITY NUMBER</b>	<b>DATE</b>	<b>COUNTRY</b>
29/449,703	15/03/2013	U.S.A.

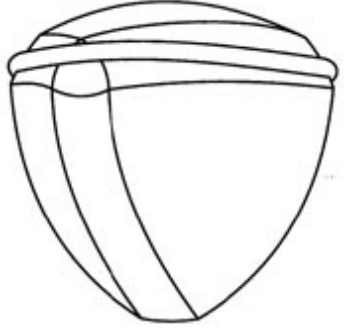
<b>DESIGN NUMBER</b>	254575	
<b>CLASS</b>	23-01	
<b>1)DRÄGER MEDICAL GMBH OF</b> MOISLINGER ALLEE 53-55, D-23558 LÜBECK, GERMANY		
<b>DATE OF REGISTRATION</b>	19/06/2013	
<b>TITLE</b>	COVER FOR CONNECTOR FOR WITHDRAWAL OF MEDIACL GAS	
<b>PRIORITY</b>		
<b>PRIORITY NUMBER</b>	<b>DATE</b>	<b>COUNTRY</b>
002156851-0002	20/12/2012	OHIM

<b>DESIGN NUMBER</b>	256617	
<b>CLASS</b>	12-11	
<b>1)TVS MOTOR COMPANY LIMITED, AN INDIAN COMPANY INCORPORATED UNDER THE COMPANIES ACT, 1956, HAVING ITS REGISTERED OFFICE AT "JAYALAKSHMI ESTATES", 29 (OLD NO. 8) HADDOWS ROAD, CHENNAI 600006, TAMIL NADU, INDIA</b>		
<b>DATE OF REGISTRATION</b>	19/09/2013	
<b>TITLE</b>	SWITCH COVER FOR SCOOTER	
<b>PRIORITY NA</b>		
<b>DESIGN NUMBER</b>	258340	
<b>CLASS</b>	13-03	
<b>1)ADLER ELECTRONICS PRIVATE LIMITED (A COMPANY INCORPORATED UNDER THE COMPANIES ACT, 1956) HAVING ITS PLACE OF BUSINESS AT STERLING, 24/A, STREET NO. 1, VIDYA KUNJ SOCIETY, AMIN MARG, RAJKOT-360006 (GUJARAT) INDIA</b>		
<b>DATE OF REGISTRATION</b>	25/11/2013	
<b>TITLE</b>	SOCKET	
<b>PRIORITY NA</b>		
<b>DESIGN NUMBER</b>	258208	
<b>CLASS</b>	09-01	
<b>1)PRAMIT SANGHAVI AND DEWANG SANGHAVI, PARTNERS TRADING AS V2 CORP., A PARTNERSHIP FIRM, INDIAN, MANUFACTURERS AND MERCHANTS, WHOSE ADDRESS IS WZ-8/1, INDUSTRIAL AREA, KIRTI NAGAR, NEW DELHI-110015, INDIA</b>		
<b>DATE OF REGISTRATION</b>	18/11/2013	
<b>TITLE</b>	JAR	
<b>PRIORITY NA</b>		

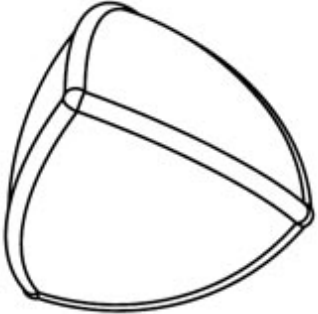
<b>DESIGN NUMBER</b>	256618		
<b>CLASS</b>	12-11		
<b>1)TVS MOTOR COMPANY LIMITED, AN INDIAN COMPANY INCORPORATED UNDER THE COMPANIES ACT, 1956, HAVING ITS REGISTERED OFFICE AT "JAYALAKSHMI ESTATES", 29 (OLD NO. 8) HADDOWS ROAD, CHENNAI 600006, TAMIL NADU, INDIA</b>			
<b>DATE OF REGISTRATION</b>	19/09/2013		
<b>TITLE</b>	PANEL REAR COVER FOR SCOOTER		
<b>PRIORITY NA</b>			
<b>DESIGN NUMBER</b>	258532		
<b>CLASS</b>	15-09		
<b>1)RELO-B LTD. (A PRIVATE LIMITED COMPANY ORGANIZED AND EXISTING UNDER THE LAWS OF BULGARIA), HAVING ITS REGISTERED OFFICE AT: 1, OBORISHTE STREET, ENTR. A, AP. 17 1504 SOFIA, BULGARIA</b>			
<b>DATE OF REGISTRATION</b>	03/12/2013		
<b>TITLE</b>	GRINDING BODY		
<b>PRIORITY</b>			
<b>PRIORITY NUMBER</b>	<b>DATE</b>	<b>COUNTRY</b>	
DM/081 103	05/06/2013	WIPO	
<b>DESIGN NUMBER</b>	256619		
<b>CLASS</b>	26-06		
<b>1)TVS MOTOR COMPANY LIMITED, AN INDIAN COMPANY INCORPORATED UNDER THE COMPANIES ACT, 1956, HAVING ITS REGISTERED OFFICE AT "JAYALAKSHMI ESTATES", 29 (OLD NO. 8) HADDOWS ROAD, CHENNAI 600006, TAMIL NADU, INDIA</b>			
<b>DATE OF REGISTRATION</b>	19/09/2013		
<b>TITLE</b>	REAR SIGNAL LAMP FOR SCOOTER		
<b>PRIORITY NA</b>			

<b>DESIGN NUMBER</b>	258353		
<b>CLASS</b>	05-06		
<b>1)SHRI MAA DISTRIBUTIONS INDIA PVT. LTD., AN INDIAN COMPANY INCORPORATED UNDER THE INDIAN COMPANIES ACT, 1956, HAVING ITS ADDRESS AT</b> 1107, HEMKUNT HOUSE, 6 RAJENDRA PLACE, DELHI-110008, INDIA			
<b>DATE OF REGISTRATION</b>	25/11/2013		
<b>TITLE</b>	FOIL WRAPPER		
<b>PRIORITY NA</b>			
<b>DESIGN NUMBER</b>	258533		
<b>CLASS</b>	15-09		
<b>1)RELO-B LTD. (A PRIVATE LIMITED COMPANY ORGANIZED AND EXISTING UNDER THE LAWS OF BULGARIA), HAVING ITS REGISTERED OFFICE AT:</b> 1, OBORISHTE STREET, ENTR. A, AP. 17 1504 SOFIA, BULGARIA			
<b>DATE OF REGISTRATION</b>	03/12/2013		
<b>TITLE</b>	GRINDING BODY		
<b>PRIORITY</b>			
<b>PRIORITY NUMBER</b>	<b>DATE</b>	<b>COUNTRY</b>	
DM/081 103	05/06/2013	WIPO	
<b>DESIGN NUMBER</b>	259009		
<b>CLASS</b>	02-04		
<b>1)SUPER TANNERY LIMITED, 187/170, JAJMAU ROAD, KANPUR-208010, U.P., INDIA.</b> (AN INDIAN COMPANY DULY REGISTERED UNDER THE COMPANIES ACT, 1956)			
<b>DATE OF REGISTRATION</b>	26/12/2013		
<b>TITLE</b>	TOE GUARD		
<b>PRIORITY NA</b>			

<b>DESIGN NUMBER</b>	256282	
<b>CLASS</b>	23-02	
1)NEOPERL GMBH, KLOSTERRUNSSTR. 11, 79379 MÜLLHEIM, GERMANY, A GERMAN COMPANY		
<b>DATE OF REGISTRATION</b>	06/09/2013	
<b>TITLE</b>	FAUCET AERATOR	
<b>PRIORITY</b>		
PRIORITY NUMBER	DATE	COUNTRY
725018001	08/03/2013	WIPO

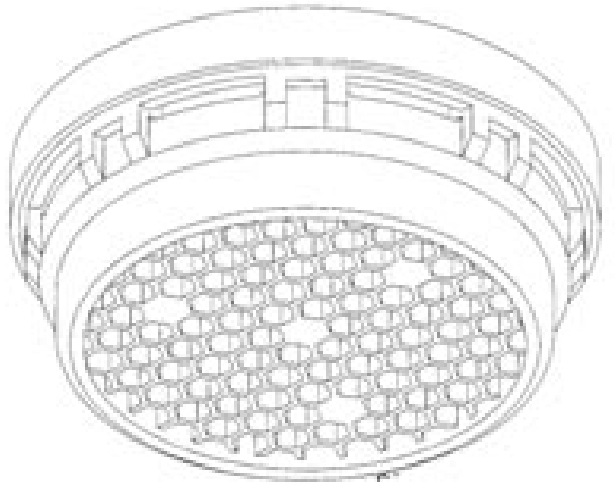



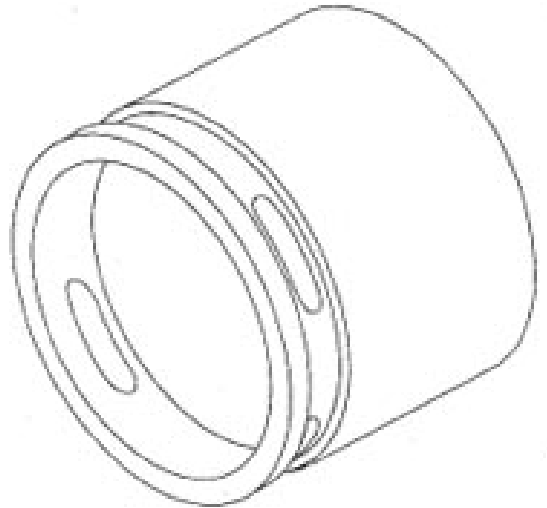

<b>DESIGN NUMBER</b>	256367	
<b>CLASS</b>	23-01	
1)THE GATES CORPORATION, A DELAWARE CORPORATION OF 1551 WEWATTA STREET, DENVER, CO 80202, U.S.A.		
<b>DATE OF REGISTRATION</b>	11/09/2013	
<b>TITLE</b>	HYDRAULIC CONNECTOR	
<b>PRIORITY</b>		
PRIORITY NUMBER	DATE	COUNTRY
29/449,856	15/03/2013	U.S.A.

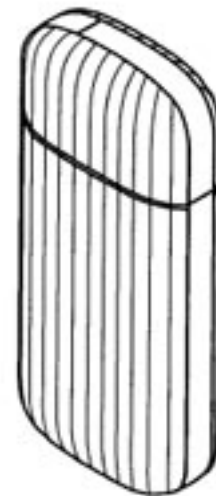

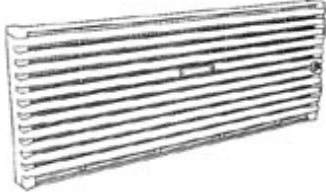
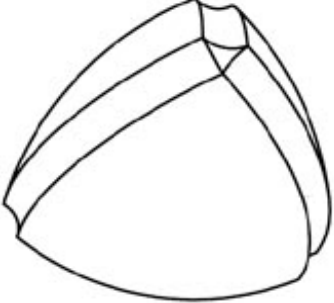

<b>DESIGN NUMBER</b>	253420	
<b>CLASS</b>	27-99	
1)PHILIP MORRIS PRODUCTS S.A., A SWISS COMPANY OF QUAI JEANRENAUD 3, 2000 NEUCHATEL, SWITZERLAND		
<b>DATE OF REGISTRATION</b>	25/04/2013	
<b>TITLE</b>	CHARGING DEVICE FOR SMOKERS ACCESSORIES	
<b>PRIORITY</b>		
PRIORITY NUMBER	DATE	COUNTRY
001349062-0002	26/10/2012	OHIM





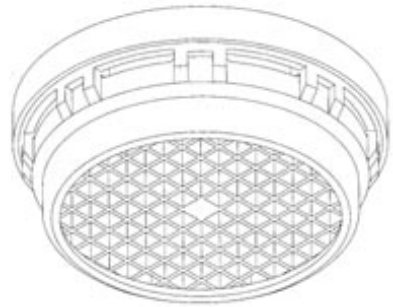

<b>DESIGN NUMBER</b>	257132		
<b>CLASS</b>	14-02		
<b>1)NEC CORPORATION, A JAPANESE COMPANY OF</b> 7-1, SHIBA 5-CHOME, MINATO-KU, TOKYO, JAPAN			
<b>DATE OF REGISTRATION</b>	01/10/2013		
<b>TITLE</b>	FRONT PANEL FOR COMPUTER		
<b>PRIORITY</b>			
<b>PRIORITY NUMBER</b>	<b>DATE</b>	<b>COUNTRY</b>	
2013-007443	02/04/2013	JAPAN	
<b>DESIGN NUMBER</b>	258534		
<b>CLASS</b>	15-09		
<b>1)RELO-B LTD. (A PRIVATE LIMITED COMPANY ORGANIZED AND</b> <b>EXISTING UNDER THE LAWS OF BULGARIA), HAVING ITS REGISTERED</b> <b>OFFICE AT:</b> 1, OBORISHTE STREET, ENTR. A, AP. 17 1504 SOFIA, BULGARIA			
<b>DATE OF REGISTRATION</b>	03/12/2013		
<b>TITLE</b>	GRINDING BODY		
<b>PRIORITY</b>			
<b>PRIORITY NUMBER</b>	<b>DATE</b>	<b>COUNTRY</b>	
DM/081 103	05/06/2013	WIPO	
<b>DESIGN NUMBER</b>	256171		
<b>CLASS</b>	28-02		
<b>1)MR. MANOJ R. THAKKAR, A PROPRIETOR OF M/S. KUTCH SOAP</b> <b>ADDRESS AT,</b> GOD GIFT BUILDING, NEAR BHUSHAN SCHOOL, KUVADVA ROAD, RAJKOT- 380003, GUJARAT, INDIA			
<b>DATE OF REGISTRATION</b>	02/09/2013		
<b>TITLE</b>	SOAP		
<b>PRIORITY NA</b>			

<b>DESIGN NUMBER</b>	256885		 <p style="text-align: center;">Front view</p>
<b>CLASS</b>	13-03		
<b>1) LARSEN &amp; TOUBRO LIMITED, AN INDIAN COMPANY INCORPORATED UNDER THE COMPANIES ACT, 1956 OF</b> L & T HOUSE, BALLARD ESTATE, MUMBAI 400001, STATE OF MAHARASHTRA, INDIA			
<b>DATE OF REGISTRATION</b>	27/09/2013		
<b>TITLE</b>	PUMP CONTROLLER		
<b>PRIORITY NA</b>			
<b>DESIGN NUMBER</b>	258808		
<b>CLASS</b>	07-01		
<b>1) GURALLAR YAPI MALZEMELERI VE KIMYA SANAYII ANONIM SIRKETI ATATURK BULVARI ESKISEHIR YOLU 5. KM, MERKEZ KUTAHYA, TURKEY</b> (A COMPANY INCORPORATED UNDER THE LAWS OF TURKEY) OF THE ABOVE ADDRESS			
<b>DATE OF REGISTRATION</b>	17/12/2013		
<b>TITLE</b>	BOWL		
<b>PRIORITY NA</b>			
<b>DESIGN NUMBER</b>	258535		
<b>CLASS</b>	15-09		
<b>1) RELO-B LTD. (A PRIVATE LIMITED COMPANY ORGANIZED AND EXISTING UNDER THE LAWS OF BULGARIA), HAVING ITS REGISTERED OFFICE AT:</b> 1, OBORISHTE STREET, ENTR. A, AP. 17 1504 SOFIA, BULGARIA			
<b>DATE OF REGISTRATION</b>	03/12/2013		
<b>TITLE</b>	GRINDING BODY		
<b>PRIORITY</b>			
<b>PRIORITY NUMBER</b>	<b>DATE</b>	<b>COUNTRY</b>	
DM/081 103	05/06/2013	WIPO	

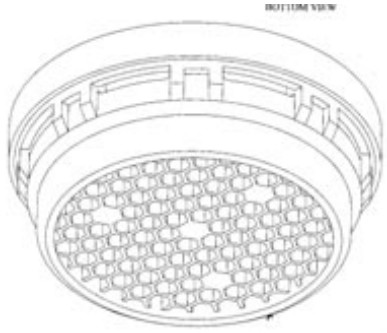
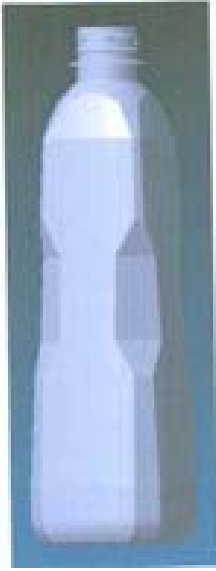
<b>DESIGN NUMBER</b>	255585		
<b>CLASS</b>	02-04		
<b>1)VEEKESY ELASTOMERS PRIVATE LIMITED, AN INDIAN COMPANY INCORPORATED UNDER COMPANIES ACT, 1956 HAVING ITS REGISTERED OFFICE AT DOOR NO. VII/330, NH 17, KOLATHARA P.O., KOZHIKODE-673655, KERALA STATE, INDIA,</b> REPRESENTED BY ITS MANAGING DIRECTOR VELUTHEDATH NOUSHAD, S/O. MR. MAMMED KOYA VKC, INDIAN AGED ABOUT 42 YEARS			
<b>DATE OF REGISTRATION</b>	01/08/2013		
<b>TITLE</b>	FOOTWEAR SOLE		
<b>PRIORITY NA</b>			
<b>DESIGN NUMBER</b>	256284		
<b>CLASS</b>	23-02		
<b>1)NEOPERL GMBH, KLOSTERRUNSSTR. 11, 79379 MÜLLHEIM, GERMANY, A GERMAN COMPANY</b>			
<b>DATE OF REGISTRATION</b>	06/09/2013		
<b>TITLE</b>	FAUCET AERATOR		
<b>PRIORITY</b>			
<b>PRIORITY NUMBER</b>	<b>DATE</b>	<b>COUNTRY</b>	
725018001	08/03/2013	WIPO	
<b>DESIGN NUMBER</b>	258752		
<b>CLASS</b>	26-05		
<b>1)INMARK EXPORTS PVT LTD, AN INDIAN COMPANY HAVING ITS OFFICE AT</b> 306-307, USHA CHAMBERS, COMMERCIAL COMPLEX, NEW RAJDHANI ENCLAVE, VIKAS MARG, NEW DELHI-110092			
<b>DATE OF REGISTRATION</b>	16/12/2013		
<b>TITLE</b>	LAMP SHADE		
<b>PRIORITY NA</b>			



<b>DESIGN NUMBER</b>	251240		
<b>CLASS</b>	23-01		
<b>1)DR. SAJI DAS APPUKUTTAN (INDIAN NATIONAL),</b> TC. 15/1551-1 HOUSE NO 46, M.P. APPAN NAGAR, VAZHUTHACADU, THYCADU.POST, TRIVANDRUM. PIN.695014, KERALA, INDIA			
<b>DATE OF REGISTRATION</b>	28/01/2013		
<b>TITLE</b>	PORTABLE BIOGAS PLANT		
<b>PRIORITY NA</b>			
<b>DESIGN NUMBER</b>	256285		
<b>CLASS</b>	23-02		
<b>1)NEOPERL GMBH,</b> KLOSTERRUNSSSTR. 11, 79379 MÜLLHEIM, GERMANY, A GERMAN COMPANY			
<b>DATE OF REGISTRATION</b>	06/09/2013		
<b>TITLE</b>	FAUCET AERATOR		
<b>PRIORITY</b>			
<b>PRIORITY NUMBER</b>	<b>DATE</b>	<b>COUNTRY</b>	
725018001	08/03/2013	WIPO	
<b>DESIGN NUMBER</b>	259469		
<b>CLASS</b>	09-01		
<b>1)PRAMIT SANGHAVI AND DEWANG SANGHAVI, PARTNERS TRADING AS</b> <b>V2 CORP., A PARTNERSHIP FIRM, INDIAN, MANUFACTURERS AND</b> <b>MERCHANTS, WHOSE ADDRESS IS</b> WZ-8/1, INDUSTRIAL AREA, KIRTI NAGAR, NEW DELHI-110015, INDIA			
<b>DATE OF REGISTRATION</b>	17/01/2014		
<b>TITLE</b>	BOTTLE		
<b>PRIORITY NA</b>			

<b>DESIGN NUMBER</b>	258393		
<b>CLASS</b>	12-08		
<b>1)HONDA MOTOR CO., LTD., A JAPANESE CORPORATION, OF 1-1, MINAMI-AOYAMA 2-CHOME, MINATO-KU, TOKYO, JAPAN</b>			
<b>DATE OF REGISTRATION</b>	26/11/2013		
<b>TITLE</b>	CAR		
<b>PRIORITY</b>			
<b>PRIORITY NUMBER</b>	<b>DATE</b>	<b>COUNTRY</b>	
2013-012162	31/05/2013	JAPAN	
<b>DESIGN NUMBER</b>	258753		
<b>CLASS</b>	26-05		
<b>1)INMARK EXPORTS PVT LTD, AN INDIAN COMPANY HAVING ITS OFFICE AT 306-307, USHA CHAMBERS, COMMERCIAL COMPLEX, NEW RAJDHANI ENCLAVE, VIKAS MARG, NEW DELHI-110092</b>			
<b>DATE OF REGISTRATION</b>	16/12/2013		
<b>TITLE</b>	LAMP SHADE		
<b>PRIORITY NA</b>			
<b>PRIORITY NUMBER</b>	<b>DATE</b>	<b>COUNTRY</b>	
<b>DESIGN NUMBER</b>	256501		
<b>CLASS</b>	10-07		
<b>1)LUMASENSE TECHNOLOGIES HOLDING, INC. A COMPANY ORGANIZED AND EXISTING UNDER THE LAWS OF UNITED STATES OF AMERICA, HAVING ITS OFFICE AT 3301 LEONARD COURT, SANTA CLARA, CALIFORNIA 95054, UNITED STATES OF AMERICA</b>			
<b>DATE OF REGISTRATION</b>	16/09/2013		
<b>TITLE</b>	SENSOR HOUSING		
<b>PRIORITY</b>			
<b>PRIORITY NUMBER</b>	<b>DATE</b>	<b>COUNTRY</b>	
29/449,837	15/03/2013	U.S.A.	

<b>DESIGN NUMBER</b>	256286		
<b>CLASS</b>	23-02		
<b>1)NEOPERL GMBH, KLOSTERRUNSSTR. 11, 79379 MÜLLHEIM, GERMANY, A GERMAN COMPANY</b>			
<b>DATE OF REGISTRATION</b>	06/09/2013		
<b>TITLE</b>	FAUCET AERATOR		
<b>PRIORITY</b>			
<b>PRIORITY NUMBER</b>	<b>DATE</b>	<b>COUNTRY</b>	
725018001	08/03/2013	WIPO	
<b>DESIGN NUMBER</b>	258266		
<b>CLASS</b>	08-05		
<b>1)1. TOM GEORGE, NADACKAL HOUSE, ARUNAPURAM P.O, PALAI, KOTTAYAM DIST, PIN 686574. 2. SUDEEP THOMAS, VATTOTHUKUNNEL HOUSE, MEENACHIL P.O, KOTTAYAM DIST, PIN 686577. 3. TOMS. P. JOSEPH, PATTARMADATHIL HOUSE, PUNNATHURA WEST P.O, ETTUMANOOR, KOTTAYAM DIST, PIN 686631. 4. JISSMON GEORGE, KANIYAMPARAMPIL HOUSE, MALLIKASSERY P.O, VILAKKUMADOM, KOTTAYAM DIST, PIN 686577. 5. K. P. OMANAKUTTAN, KULATHUNKAL HOUSE, POOVARANI P.O, PAIKA, KOTTAYAM, PIN 686577 INDIAN NATIONALS</b>			
<b>DATE OF REGISTRATION</b>	21/11/2013		
<b>TITLE</b>	PAVEMENT TILE DEMOLDING APPARTATUS		
<b>PRIORITY NA</b>			
<b>DESIGN NUMBER</b>	258754		
<b>CLASS</b>	26-05		
<b>1)INMARK EXPORTS PVT LTD, AN INDIAN COMPANY HAVING ITS OFFICE AT 306-307, USHA CHAMBERS, COMMERCIAL COMPLEX, NEW RAJDHANI ENCLAVE, VIKAS MARG, NEW DELHI-110092</b>			
<b>DATE OF REGISTRATION</b>	16/12/2013		
<b>TITLE</b>	LAMP SHADE		
<b>PRIORITY NA</b>			
			

<b>DESIGN NUMBER</b>	254850		
<b>CLASS</b>	24-03		
<b>1)LIMBS INTERNATIONAL, INC., A COMPANY OF U.S.A.</b> OF 500 W. OVERLAND, SUITE 230, EL PASO, TEXAS 79901, USA			
<b>DATE OF REGISTRATION</b>	28/06/2013		
<b>TITLE</b>	PROSTHETIC KNEE		
<b>PRIORITY</b>			
<b>PRIORITY NUMBER</b>	<b>DATE</b>	<b>COUNTRY</b>	
29/444,705	01/02/2013	U.S.A.	
<b>DESIGN NUMBER</b>	255990		
<b>CLASS</b>	12-16		
<b>1)AAV INDUSTRIES SDN BHD, A COMPANY INCORPORATED ACCORDING TO THE LAWS OF MALAYSIA, HAVING ITS ADDRESS AT:</b> NO 7 JLN PJS 7/19, BANDAR SUNWAY, 46150 PETALING JAYA, MALAYSIA			
<b>DATE OF REGISTRATION</b>	23/08/2013		
<b>TITLE</b>	REAR-VIEW MIRROR FOR VEHICLES		
<b>PRIORITY NA</b>			
<b>DESIGN NUMBER</b>	259067		
<b>CLASS</b>	26-03		
<b>1)CROMPTON GREAVES LIMITED,</b> CG HOUSE, 6TH FLOOR, DR. ANNIE BESANT ROAD, WORLI, MUMBAI - 400030, MAHARASHTRA, INDIA; AN INDIAN COMPANY			
<b>DATE OF REGISTRATION</b>	27/12/2013		
<b>TITLE</b>	LIGHTING FIXTURE		
<b>PRIORITY NA</b>			

<b>DESIGN NUMBER</b>	256287	
<b>CLASS</b>	23-02	
1)NEOPERL GMBH, KLOSTERRUNSSTR. 11, 79379 MÜLLHEIM, GERMANY, A GERMAN COMPANY		
<b>DATE OF REGISTRATION</b>	06/09/2013	
<b>TITLE</b>	FAUCET AERATOR	
<b>PRIORITY</b>		
<b>PRIORITY NUMBER</b>	<b>DATE</b>	<b>COUNTRY</b>
725018001	08/03/2013	WIPO

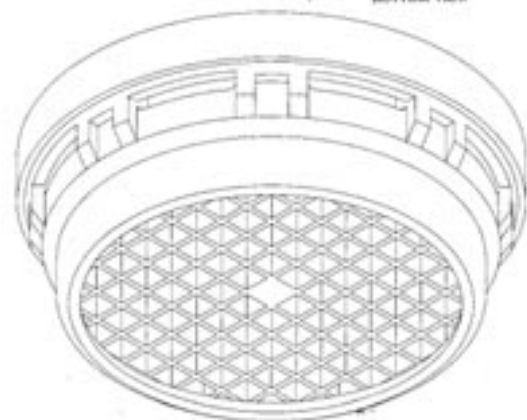

<b>DESIGN NUMBER</b>	254448	
<b>CLASS</b>	10-01	
1)RAMYA PADMANABHAN, AN INDIVIDUAL, HAVING PLACE OF BUSINESS AT NO: 67/2, FLAT NO: 128, PARIWAR PALACE, DEVARACHIKANAHALLI MAIN ROAD, BANGALORE-560076, INDIA		
<b>DATE OF REGISTRATION</b>	12/06/2013	
<b>TITLE</b>	CLOCK	
<b>PRIORITY NA</b>		



<b>DESIGN NUMBER</b>	258272	
<b>CLASS</b>	02-02	
1)SWASTIKA GARMENTS OF 4, RAMKUMAR RAKSHIT LANE, KOLKATA-700007, WEST BENGAL, INDIA, AN INDIAN PROPRIETORSHIP FIRM WHOSE PROPRIETOR IS BRIJGOPAL MUNDHARA, AN INDIAN OF THE ABOVE ADDRESS		
<b>DATE OF REGISTRATION</b>	21/11/2013	
<b>TITLE</b>	GARMENT SET	
<b>PRIORITY NA</b>		



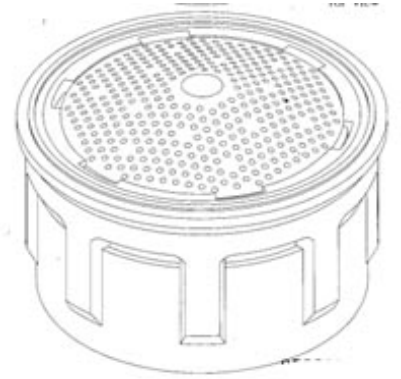

<b>DESIGN NUMBER</b>	258755	
<b>CLASS</b>	26-05	
<b>1)INMARK EXPORTS PVT LTD, AN INDIAN COMPANY HAVING ITS OFFICE AT</b> 306-307, USHA CHAMBERS, COMMERCIAL COMPLEX, NEW RAJDHANI ENCLAVE, VIKAS MARG, NEW DELHI-110092		
<b>DATE OF REGISTRATION</b>	16/12/2013	
<b>TITLE</b>	LAMP SHADE	
<b>PRIORITY NA</b>		
<b>DESIGN NUMBER</b>	259068	
<b>CLASS</b>	15-02	
<b>1)CROMPTON GREAVES LIMITED,</b> CG HOUSE, 6TH FLOOR, DR. ANNIE BESANT ROAD, WORLI, MUMBAI - 400030, MAHARASHTRA, INDIA; AN INDIAN COMPANY		
<b>DATE OF REGISTRATION</b>	27/12/2013	
<b>TITLE</b>	PUMP	
<b>PRIORITY NA</b>		
<b>DESIGN NUMBER</b>	256542	
<b>CLASS</b>	24-02	
<b>1)GENERAL ELECTRIC COMPANY,</b> 1 RIVER ROAD, SCHENECTADY, NEW YORK 12345, USA, NEW YORK CORPORATION		
<b>DATE OF REGISTRATION</b>	17/09/2013	
<b>TITLE</b>	INFANT WARMER	
<b>PRIORITY NA</b>		

<b>DESIGN NUMBER</b>	256288	
<b>CLASS</b>	23-02	
<b>1)NEOPERL GMBH, KLOSTERRUNSSTR. 11, 79379 MÜLLHEIM, GERMANY, A GERMAN COMPANY</b>		
<b>DATE OF REGISTRATION</b>	06/09/2013	
<b>TITLE</b>	FLOW REGULATOR FOR SANITARY APPLIANCES	
<b>PRIORITY</b>		
<b>PRIORITY NUMBER</b>	<b>DATE</b>	<b>COUNTRY</b>
725354801	11/03/2013	WIPO
<b>DESIGN NUMBER</b>	258400	
<b>CLASS</b>	23-02	
<b>1)TOTO LTD., A COMPANY ORGANIZED AND EXISTING UNDER THE LAWS OF JAPAN, MANUFACTURERS AND MERCHANTS, OF THE ADDRESS 1-1, NAKASHIMA 2-CHOME, KOKURAKITA-KU, KITAKYUSHU-SHI, FUKUOKA 802-8601, JAPAN</b>		
<b>DATE OF REGISTRATION</b>	26/11/2013	
<b>TITLE</b>	WATER CLOSET	
<b>PRIORITY NA</b>		
<b>DESIGN NUMBER</b>	256039	
<b>CLASS</b>	03-01	
<b>1)CHRISTIAN DIOR COUTURE, A FRENCH PUBLIC LIMITED COMPANY OF 30 AVENUE MONTAIGNE, 75008 PARIS, FRANCE</b>		
<b>DATE OF REGISTRATION</b>	26/08/2013	
<b>TITLE</b>	HAND BAG	
<b>PRIORITY</b>		
<b>PRIORITY NUMBER</b>	<b>DATE</b>	<b>COUNTRY</b>
723970201	27/02/2013	WIPO







<b>DESIGN NUMBER</b>	259072		
<b>CLASS</b>	23-03		
<b>1)CROMPTON GREAVES LIMITED,</b> CG HOUSE, 6TH FLOOR, DR. ANNIE BESANT ROAD, WORLI, MUMBAI - 400030, MAHARASHTRA, INDIA; AN INDIAN COMPANY			
<b>DATE OF REGISTRATION</b>	27/12/2013		
<b>TITLE</b>	WATER HEATER		
<b>PRIORITY NA</b>			
<b>DESIGN NUMBER</b>	256290		
<b>CLASS</b>	23-02		
<b>1)NEOPERL GMBH,</b> KLOSTERRUNSSTR. 11, 79379 MÜLLHEIM, GERMANY, A GERMAN COMPANY			
<b>DATE OF REGISTRATION</b>	06/09/2013		
<b>TITLE</b>	FLOW REGULATOR FOR SANITARY APPLIANCES		
<b>PRIORITY</b>			
<b>PRIORITY NUMBER</b>	<b>DATE</b>	<b>COUNTRY</b>	
725018801	08/03/2013	WIPO	
<b>DESIGN NUMBER</b>	256836		
<b>CLASS</b>	26-05		
<b>1)FLOS S.P.A., AN ITALIAN COMPANY,</b> VIA A. FAINI, 2, I-25073 BOVEZZO, BRESCIA, ITALY			
<b>DATE OF REGISTRATION</b>	26/09/2013		
<b>TITLE</b>	FLOOR LAMP		
<b>PRIORITY</b>			
<b>PRIORITY NUMBER</b>	<b>DATE</b>	<b>COUNTRY</b>	
BS2013O000012	29/03/2013	ITALY	



<b>DESIGN NUMBER</b>	254494		
<b>CLASS</b>	22-01		
<b>1)MAGPUL INDUSTRIES CORPORATION,</b> 400 YOUNG COURT, UNIT 1, ERIE, COLORADO 80516, UNITED STATES OF AMERICA, A COLORADO CORPORATION			
<b>DATE OF REGISTRATION</b>	13/06/2013		
<b>TITLE</b>	FIREARM GRIP		
<b>PRIORITY</b>			
<b>PRIORITY NUMBER</b>	<b>DATE</b>	<b>COUNTRY</b>	
29/441,004	29/12/2012	U.S.A.	
<b>DESIGN NUMBER</b>	258230		
<b>CLASS</b>	99-00		
<b>1)BHARAT VASUDEV GIDWANI INDIAN NATIONAL, RESIDING AT</b> BUNGLOW NO. 12 A, STAVLEY ROAD, PUNE 411001 MAHARASHTRA, INDIA			
<b>DATE OF REGISTRATION</b>	19/11/2013		
<b>TITLE</b>	OIL DIFFUSER		
<b>PRIORITY NA</b>			
<b>DESIGN NUMBER</b>	258756		
<b>CLASS</b>	26-05		
<b>1)INMARK EXPORTS PVT LTD, AN INDIAN COMPANY HAVING ITS OFFICE AT</b> 306-307, USHA CHAMBERS, COMMERCIAL COMPLEX, NEW RAJDHANI ENCLAVE, VIKAS MARG, NEW DELHI-110092			
<b>DATE OF REGISTRATION</b>	16/12/2013		
<b>TITLE</b>	LAMP SHADE		
<b>PRIORITY NA</b>			

<b>DESIGN NUMBER</b>	256038		
<b>CLASS</b>	03-01		
<b>1)CHRISTIAN DIOR COUTURE, A FRENCH PUBLIC LIMITED COMPANY OF 30 AVENUE MONTAIGNE, 75008 PARIS, FRANCE</b>			
<b>DATE OF REGISTRATION</b>	26/08/2013		
<b>TITLE</b>	HAND BAG		
<b>PRIORITY</b>			
<b>PRIORITY NUMBER</b>	<b>DATE</b>	<b>COUNTRY</b>	
723970201	27/02/2013	WIPO	
<b>DESIGN NUMBER</b>	259070		
<b>CLASS</b>	26-03		
<b>1)CROMPTON GREAVES LIMITED, CG HOUSE, 6TH FLOOR, DR. ANNIE BESANT ROAD, WORLI, MUMBAI - 400030, MAHARASHTRA, INDIA; AN INDIAN COMPANY</b>			
<b>DATE OF REGISTRATION</b>	27/12/2013		
<b>TITLE</b>	LIGHTING FIXTURE		
<b>PRIORITY NA</b>			
<b>DESIGN NUMBER</b>	255200		
<b>CLASS</b>	12-16		
<b>1)DEERE &amp; COMPANY, A US CORPORATION OF ONE JOHN DEERE PLACE, MOLINE, ILLINOIS, 61265 - 8098, USA</b>			
<b>DATE OF REGISTRATION</b>	12/07/2013		
<b>TITLE</b>	BEZEL UNIT SET FOR VEHICLE		
<b>PRIORITY NA</b>			

<b>DESIGN NUMBER</b>	256289		
<b>CLASS</b>	23-02		
<b>1)NEOPERL GMBH, KLOSTERRUNSSTR. 11, 79379 MÜLLHEIM, GERMANY, A GERMAN COMPANY</b>			
<b>DATE OF REGISTRATION</b>	06/09/2013		
<b>TITLE</b>	FLOW REGULATOR FOR SANITARY APPLIANCES		
<b>PRIORITY</b>			
<b>PRIORITY NUMBER</b>	<b>DATE</b>	<b>COUNTRY</b>	
725354801	11/03/2013	WIPO	
<b>DESIGN NUMBER</b>	253326		
<b>CLASS</b>	24-02		
<b>1)KRISHNA INSTITUTE OF MEDICAL SCIENCES THROUGH DR. M. V. GHORPADE (REGISTRAR), NEAR DHEBEWADI ROAD, MALKAPUR, KARAD, MAHARASHTRA, INDIA</b>			
<b>DATE OF REGISTRATION</b>	23/04/2013		
<b>TITLE</b>	MEDICAL AID FOR ANESTHESIOLOGISTS AS AN ATTACHMENT FOR LARYNGOSCOPE BLADE		
<b>PRIORITY NA</b>			
<b>DESIGN NUMBER</b>	256291		
<b>CLASS</b>	23-02		
<b>1)NEOPERL GMBH, KLOSTERRUNSSTR. 11, 79379 MÜLLHEIM, GERMANY, A GERMAN COMPANY</b>			
<b>DATE OF REGISTRATION</b>	06/09/2013		
<b>TITLE</b>	FLOW REGULATOR FOR SANITARY APPLIANCES		
<b>PRIORITY</b>			
<b>PRIORITY NUMBER</b>	<b>DATE</b>	<b>COUNTRY</b>	
725018801	08/03/2013	WIPO	

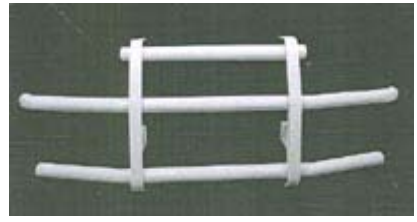
<b>DESIGN NUMBER</b>	256837		
<b>CLASS</b>	26-05		
<b>1)FLOS S.P.A., AN ITALIAN COMPANY, VIA A. FAINI, 2, I-25073 BOVEZZO, BRESCIA, ITALY.</b>			
<b>DATE OF REGISTRATION</b>	26/09/2013		
<b>TITLE</b>	FLOOR LAMP		
<b>PRIORITY</b>			
<b>PRIORITY NUMBER</b>	<b>DATE</b>	<b>COUNTRY</b>	
BS2013O000012	29/03/2013	ITALY	
<b>DESIGN NUMBER</b>	254495		
<b>CLASS</b>	22-01		
<b>1)MAGPUL INDUSTRIES CORPORATION, 400 YOUNG COURT, UNIT 1, ERIE, COLORADO 80516, UNITED STATES OF AMERICA, A COLORADO CORPORATION</b>			
<b>DATE OF REGISTRATION</b>	13/06/2013		
<b>TITLE</b>	CONNECTION RING FOR A FIREARM SLING		
<b>PRIORITY</b>			
<b>PRIORITY NUMBER</b>	<b>DATE</b>	<b>COUNTRY</b>	
29/439,689	13/12/2012	U.S.A.	
<b>DESIGN NUMBER</b>	258090		
<b>CLASS</b>	12-16		
<b>1)SAMSUDIN SEAYEDH, INDIAN, S/O HASAN ALI SEAYEDH, NH 89, NAGAUR ROAD, RAILWAY CROSSING, NOKHA, BIKANER-334803 (RAJASTHAN)</b>			
<b>DATE OF REGISTRATION</b>	12/11/2013		
<b>TITLE</b>	CAR BUMPER GUARD		
<b>PRIORITY NA</b>			

<b>DESIGN NUMBER</b>	258761	
<b>CLASS</b>	09-09	
1)MOLOK OY, NOSTURIKATU 16, 37100 NOKIA, FINLAND, NATIONALITY: FINLAND		
<b>DATE OF REGISTRATION</b>	16/12/2013	
<b>TITLE</b>	REFUSE RECEPTACLES	
<b>PRIORITY</b>		
PRIORITY NUMBER	DATE	COUNTRY
002256578-0001	17/06/2013	OHIM



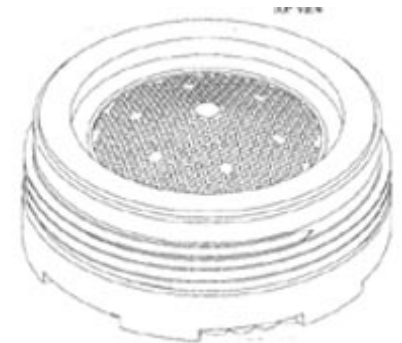

<b>DESIGN NUMBER</b>	256292	
<b>CLASS</b>	23-02	
1)NEOPERL GMBH, KLOSTERRUNSSTR. 11, 79379 MÜLLHEIM, GERMANY, A GERMAN COMPANY		
<b>DATE OF REGISTRATION</b>	06/09/2013	
<b>TITLE</b>	FLOW REGULATOR FOR SANITARY APPLIANCES	
<b>PRIORITY</b>		
PRIORITY NUMBER	DATE	COUNTRY
725018801	08/03/2013	WIPO



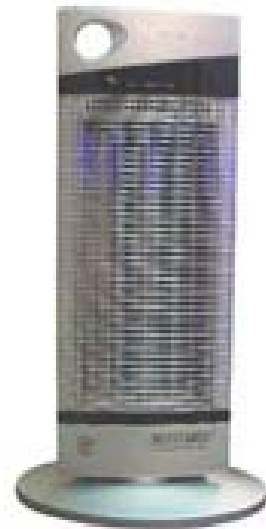

<b>DESIGN NUMBER</b>	255813	
<b>CLASS</b>	23-03	
1)MUKESH KUMAR AGARWAL (DIRECTOR), NATIONALITY INDIAN TRADING AS KIRANOTICS INDIA PVT. LTD. (THIS IS A PRIVATE LIMITED COMPANY INCORPORATED UNDER COMPANIES ACT, 1956) WHOES ADDRESS IS D-15, SITE-C, INDUSTRIAL AREA, SIKANDRA, AGRA, UTTAR PRADESH (INDIA)		
<b>DATE OF REGISTRATION</b>	14/08/2013	
<b>TITLE</b>	ELECTRIC HEATER	
<b>PRIORITY NA</b>		

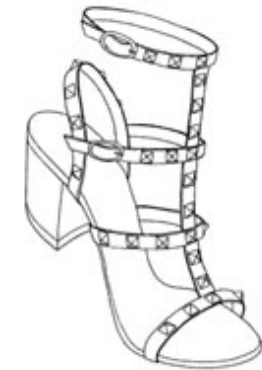

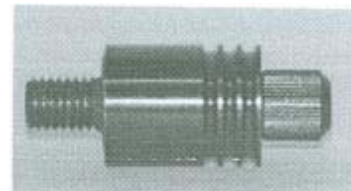

<b>DESIGN NUMBER</b>	256293		
<b>CLASS</b>	23-02		
<b>1)NEOPERL GMBH, KLOSTERRUNSSTR. 11, 79379 MÜLLHEIM, GERMANY, A GERMAN COMPANY</b>			
<b>DATE OF REGISTRATION</b>	06/09/2013		
<b>TITLE</b>	FLOW REGULATOR FOR SANITARY APPLIANCES		
<b>PRIORITY</b>			
<b>PRIORITY NUMBER</b>	<b>DATE</b>	<b>COUNTRY</b>	
725018801	08/03/2013	WIPO	
<b>DESIGN NUMBER</b>	257191		
<b>CLASS</b>	08-06		
<b>1)ROYAL, AN INDIAN PARTNERSHIP FIRM AT C-2/314, G.I.D.C., SHANKER TEKARI UDYOG NAGAR, JAMNAGAR-361004, GUJARAT, (INDIA) WHOSE PARTNERS ARE AMRUTLAL SAMAT HARIA, AMRUTLAL NARSHI KHIMASIA AND SARLABEN SAVLA, ALL INDIAN OF ABOVE ADDRESS</b>			
<b>DATE OF REGISTRATION</b>	04/10/2013		
<b>TITLE</b>	HINGE		
<b>PRIORITY NA</b>			
<b>DESIGN NUMBER</b>	252959		
<b>CLASS</b>	08-08		
<b>1)GOLDEN PEACOCK OVERSEAS LIMITED, AN INDIAN COMPANY REGISTERED UNDER THE INDIAN COMPANIES ACT, 3E/2, JHANDEWALAN EXTN., NEW DELHI-110055</b>			
<b>DATE OF REGISTRATION</b>	08/04/2013		
<b>TITLE</b>	WIRE SUSPENSION DEVICE		
<b>PRIORITY NA</b>			

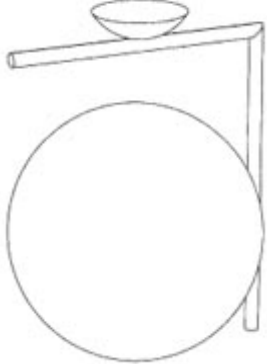

<b>DESIGN NUMBER</b>	258639			
<b>CLASS</b>	02-04			
<b>1)VALENTINO S.P.A., A CORPORATION ORGANIZED AND EXISTING UNDER THE LAWS OF ITALY, OF VIA TURATI, 16/18, I-20121 MILANO, ITALY</b>				
<b>DATE OF REGISTRATION</b>	09/12/2013			
<b>TITLE</b>	SHOE			
<b>PRIORITY</b>				
<b>PRIORITY NUMBER</b>	<b>DATE</b>	<b>COUNTRY</b>		
MI2013O000144	11/06/2013	ITALY		
<b>DESIGN NUMBER</b>				
<b>CLASS</b>	06-01			
<b>1)STEELCASE INC. 901 44TH STREET S.E. GRAND RAPIDS, MICHIGAN 49508 U.S.A. NATIONALITY: U.S.A.</b>				
<b>DATE OF REGISTRATION</b>	14/06/2013			
<b>TITLE</b>	CHAIR			
<b>PRIORITY</b>				
<b>PRIORITY NUMBER</b>	<b>DATE</b>	<b>COUNTRY</b>		
001358774-0001	15/01/2013	OHIM		
<b>DESIGN NUMBER</b>				
<b>CLASS</b>	08-08			
<b>1)GOLDEN PEACOCK OVERSEAS LIMITED, AN INDIAN COMPANY REGISTERED UNDER THE INDIAN COMPANIES ACT, 3E/2, JHANDEWALAN EXTN., NEW DELHI-110055</b>				
<b>DATE OF REGISTRATION</b>	08/04/2013			
<b>TITLE</b>	WIRE SUSPENSION DEVICE			
<b>PRIORITY NA</b>				



<b>DESIGN NUMBER</b>	256621		
<b>CLASS</b>	26-06		
<b>1)TVS MOTOR COMPANY LIMITED, AN INDIAN COMPANY INCORPORATED UNDER THE COMPANIES ACT, 1956, HAVING ITS REGISTERED OFFICE AT "JAYALAKSHMI ESTATES", 29 (OLD NO. 8) HADDOWS ROAD, CHENNAI 600006, TAMIL NADU, INDIA</b>			
<b>DATE OF REGISTRATION</b>	19/09/2013		
<b>TITLE</b>	FRONT SIGNAL LAMP FOR SCOOTER		
<b>PRIORITY NA</b>			
<b>DESIGN NUMBER</b>	246164		
<b>CLASS</b>	08-07		
<b>1)SURESH MARUTI MORE. (AN INDIAN NATIONAL) 102/B, SUKH SHANTI ASHRAM, BORIVALI (WEST), MUMBAI-400103, STATE OF MAHARASHTRA, INDIA.</b> PROPRIETOR OF ENOPECK SEALS (INDIA), AN INDIAN PROPRIETOR SHIP FIRM OF ABOVE ADDRESS			
<b>DATE OF REGISTRATION</b>	25/06/2012		
<b>TITLE</b>	SEAL		
<b>PRIORITY NA</b>			
<b>DESIGN NUMBER</b>	256841		
<b>CLASS</b>	26-05		
<b>1)FLOS S.P.A., AN ITALIAN COMPANY, VIA A. FAINI, 2, I-25073 BOVEZZO, BRESCIA, ITALY.</b>			
<b>DATE OF REGISTRATION</b>	26/09/2013		
<b>TITLE</b>	CEILING LAMP		
<b>PRIORITY</b>			
<b>PRIORITY NUMBER</b>	<b>DATE</b>	<b>COUNTRY</b>	
BS2013O000012	29/03/2013	ITALY	



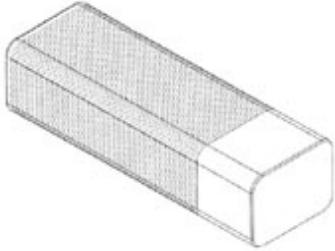

<b>DESIGN NUMBER</b>	258788		
<b>CLASS</b>	12-11		
<b>1)TUBE INVESTMENTS OF INDIA LIMITED, AN INDIAN COMPANY INCORPORATED UNDER THE COMPANIES ACT OF 1956, HAVING ITS PRINCIPAL PLACE OF BUSINESS AT</b> "DARE HOUSE", 234, N. S. C. BOSE ROAD, CHENNAI - 600001, STATE OF TAMIL NADU, INDIA			
<b>DATE OF REGISTRATION</b>	17/12/2013		
<b>TITLE</b>	HANDLEBAR FOR BICYCLE		
<b>PRIORITY NA</b>			
<b>DESIGN NUMBER</b>	253781		
<b>CLASS</b>	06-01		
<b>1)SHISHU PAL JASUJA, PROPRIETOR SIGMA INDUSTRIES AT</b> PLOT NO. 80 PART A M.I.E. BHADURGARH HARYANA			
<b>DATE OF REGISTRATION</b>	13/05/2013		
<b>TITLE</b>	CYCLE SEAT		
<b>PRIORITY NA</b>			
<b>DESIGN NUMBER</b>	255472		
<b>CLASS</b>	14-99		
<b>1)BARCO N.V.,</b> PRESIDENT KENNEDYPARK 35, B-8500 KORTRIJK, BELGIUM			
<b>DATE OF REGISTRATION</b>	29/07/2013		
<b>TITLE</b>	VIDEO DISPLAY SYSTEM		
<b>PRIORITY</b>			
<b>PRIORITY NUMBER</b>	<b>DATE</b>	<b>COUNTRY</b>	
002266635	02/07/2013	OHIM	
<b>DESIGN NUMBER</b>	256519		
<b>CLASS</b>	15-07		
<b>1)BSH BOSCH UND SIEMENS HAUSGERÄTE GMBH, OF</b> CARL-WERY - STR.34, 81739, MUNICH, GERMANY, A GERMAN COMPANY			
<b>DATE OF REGISTRATION</b>	16/09/2013		
<b>TITLE</b>	REFRIGERATOR SHELF		
<b>PRIORITY NA</b>			

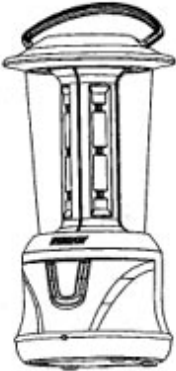
<b>DESIGN NUMBER</b>	246165	
<b>CLASS</b>	08-07	
<b>1)SURESH MARUTI MORE. (AN INDIAN NATIONAL) 102/B, SUKH SHANTI ASHRAM, BORIVALI (WEST), MUMBAI-400103, STATE OF MAHARASHTRA, INDIA.</b> PROPRIETOR OF ENOPECK SEALS (INDIA), AN INDIAN PROPRIETOR SHIP FIRM OF ABOVE ADDRESS		
<b>DATE OF REGISTRATION</b>	25/06/2012	
<b>TITLE</b>	SEAL	
<b>PRIORITY NA</b>		
<b>DESIGN NUMBER</b>	256329	
<b>CLASS</b>	24-04	
<b>1)RAJ KUMAR GROVER, SOLE PROPRIETOR OF PHARMATECH DISTRIBUTORS WHOSE ADDRESS IS</b> S-12, SHIVAJI PARK MARKET, PUNJABI BAGH, NEW DELHI-110026, INDIA, AN INDIAN NATIONAL OF ABOVE ADDRESS		
<b>DATE OF REGISTRATION</b>	10/09/2013	
<b>TITLE</b>	LEGS ELEVATOR FOR PATIENTS	
<b>PRIORITY NA</b>		
<b>DESIGN NUMBER</b>	259288	
<b>CLASS</b>	26-02	
<b>1)EVEREADY INDUSTRIES INDIA LTD.</b> 1, MIDDLETON STREET, KOLKATA-700071, WEST BENGAL, INDIA, AN INDIAN COMPANY		
<b>DATE OF REGISTRATION</b>	07/01/2014	
<b>TITLE</b>	TORCH	
<b>PRIORITY NA</b>		

<b>DESIGN NUMBER</b>	256636		
<b>CLASS</b>	04-02		
<b>1)ANCHOR HEALTH &amp; BEAUTY CARE PVT. LTD., 201-C, WING, INNOVA MARATHON NEXT GEN., OFF G.K.MARG, OPP. PENINSULA CORPORATE PARK, LOWER PAREL (W), MUMBAI-400013. STATE OF MAHARASHTRA INDIA,</b>			
/ A PRIVATE LIMITED COMPANY INCORPORATED UNDER INDIAN COMPANIES ACT., ABOVE ADDRESS			
<b>DATE OF REGISTRATION</b>	20/09/2013		
<b>TITLE</b>	TOOTH BRUSH		
<b>PRIORITY NA</b>			
<b>DESIGN NUMBER</b>	255478		
<b>CLASS</b>	14-99		
<b>1)BARCO N.V., PRESIDENT KENNEDYPARK 35, B-8500 KORTRIJK, BELGIUM</b>			
<b>DATE OF REGISTRATION</b>	29/07/2013		
<b>TITLE</b>	VIDEO DISPLAY SYSTEM		
<b>PRIORITY</b>			
<b>PRIORITY NUMBER</b>	<b>DATE</b>	<b>COUNTRY</b>	
002266635	02/07/2013	OHIM	
<b>DESIGN NUMBER</b>	256353		
<b>CLASS</b>	14-01		
<b>1)SAMSUNG ELECTRONICS CO., LTD., A KOREAN COMPANY, OF 129, SAMSUNG-RO, YEONGTONG-GU, SUWON-SI, GYEONGGI-DO, 443-742M REPUBLIC OF KOREA</b>			
<b>DATE OF REGISTRATION</b>	10/09/2013		
<b>TITLE</b>	AUDIO DEVICE		
<b>PRIORITY</b>			
<b>PRIORITY NUMBER</b>	<b>DATE</b>	<b>COUNTRY</b>	
30-2013-0012811	13/03/2013	KOREA(SOUTH)	

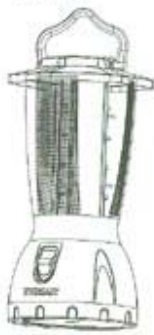
<b>DESIGN NUMBER</b>	259293	
<b>CLASS</b>	26-02	
<b>1)EVEREADY INDUSTRIES INDIA LTD.</b> 1, MIDDLETON STREET, KOLKATA-700071, WEST BENGAL, INDIA, AN INDIAN COMPANY		
<b>DATE OF REGISTRATION</b>	07/01/2014	
<b>TITLE</b>	LANTERN	
<b>PRIORITY NA</b>		
<b>DESIGN NUMBER</b>	258791	
<b>CLASS</b>	12-11	
<b>1)TUBE INVESTMENTS OF INDIA LIMITED, AN INDIAN COMPANY INCORPORATED UNDER THE COMPANIES ACT OF 1956, HAVING ITS PRINCIPAL PLACE OF BUSINESS AT</b> “DARE HOUSE”, 234, N. S. C. BOSE ROAD, CHENNAI - 600001, STATE OF TAMIL NADU, INDIA		
<b>DATE OF REGISTRATION</b>	17/12/2013	
<b>TITLE</b>	FRAME FOR BICYCLE	
<b>PRIORITY NA</b>		
<b>DESIGN NUMBER</b>	256634	
<b>CLASS</b>	04-02	
<b>1)ANCHOR HEALTH &amp; BEAUTY CARE PVT. LTD., 201-C, WING, INNOVA MARATHON NEXT GEN., OFF G.K.MARG, OPP. PENINSULA CORPORATE PARK, LOWER PAREL (W), MUMBAI-400013. STATE OF MAHARASHTRA INDIA,</b> / A PRIVATE LIMITED COMPANY INCORPORATED UNDER INDIAN COMPANIES ACT., ABOVE ADDRESS		
<b>DATE OF REGISTRATION</b>	20/09/2013	
<b>TITLE</b>	TOOTH BRUSH	
<b>PRIORITY NA</b>		

<b>DESIGN NUMBER</b>	255654	
<b>CLASS</b>	08-06	
<b>1)(1) CHOVIYA JAGDISHBHAI HARIBHAI (2) VASUBHAI BHUPATBHAI GADHIYA (3) SUKHABHAI CHHAGANBHAI VAGHASIYA (ALL THE PARTNERS ARE ADULT &amp; INDIAN NATIONAL) PARTNERS OF GODNESS SALES CORPORATION (INDIAN PARTNERSHIP FIRM) HAVING PLACE OF BUSINESS AT- RANUJANAGAR STREET NO.2, BAJRANG PAN STREET, KOTHARIYA RING ROAD, RAJKOT-360002-GUJARAT-(INDIA)</b>		
<b>DATE OF REGISTRATION</b>	06/08/2013	
<b>TITLE</b>	HANDLE	
<b>PRIORITY NA</b>		
<b>DESIGN NUMBER</b>	259292	
<b>CLASS</b>	26-02	
<b>1)EVEREADY INDUSTRIES INDIA LTD. 1, MIDDLETON STREET, KOLKATA-700071, WEST BENGAL, INDIA, AN INDIAN COMPANY</b>		
<b>DATE OF REGISTRATION</b>	07/01/2014	
<b>TITLE</b>	LANTERN	
<b>PRIORITY NA</b>		
<b>DESIGN NUMBER</b>	258789	
<b>CLASS</b>	12-11	
<b>1)TUBE INVESTMENTS OF INDIA LIMITED, AN INDIAN COMPANY INCORPORATED UNDER THE COMPANIES ACT OF 1956, HAVING ITS PRINCIPAL PLACE OF BUSINESS AT "DARE HOUSE", 234, N. S. C. BOSE ROAD, CHENNAI - 600001, STATE OF TAMIL NADU, INDIA</b>		
<b>DATE OF REGISTRATION</b>	17/12/2013	
<b>TITLE</b>	CARRIER ASSEMBLY FOR BICYCLE	
<b>PRIORITY NA</b>		

<b>DESIGN NUMBER</b>	246166	
<b>CLASS</b>	08-07	
<b>1)SURESH MARUTI MORE. (AN INDIAN NATIONAL) 102/B, SUKH SHANTI ASHRAM, BORIVALI (WEST), MUMBAI-400103, STATE OF MAHARASHTRA, INDIA.</b> PROPRIETOR OF ENOPECK SEALS (INDIA), AN INDIAN PROPRIETOR SHIP FIRM OF ABOVE ADDRESS		
<b>DATE OF REGISTRATION</b>	25/06/2012	
<b>TITLE</b>	SEAL	
<b>PRIORITY NA</b>		