

CONTINUED FROM PART- 1

INTRODUCTION



In view of the recent amendment made in the Designs (Amendment) Rules, 2008 with effect from 17/06/2008, Publication of the matter relating to Designs is being published in the Official Journal of The Patent Office. This Journal is being published on weekly basis on every Friday covering the various proceedings on Designs as required according to the provisions of under Rule 22, 25, 27 and 39 of the Design (Amendment) Rules, 2008. All the enquiries on this Official Journal and other information as required by the public should be addressed to the Controller General of Patents, Designs & Trade Marks. Suggestions and comments are requested from all quarters so that the content can be enriched.

COPYRIGHT PUBLICATION

| SL NO | REGISTERED DESIGN NUMBERS | RENEWED ON |
|--------------|----------------------------------|-------------------|
| 1. | 184889 | 28.05.2014 |
| 2. | 193262 | 27.05.2014 |
| 3. | 194592 | 28.05.2014 |
| 4. | 194785 | 28.05.2014 |
| 5. | 195019 | 29.05.2014 |
| 6. | 195023 | 27.05.2014 |
| 7. | 196361 | 27.05.2014 |
| 8. | 196421 | 28.05.2014 |
| 9. | 197121 | 27.05.2014 |
| 10. | 197129 | 27.05.2014 |
| 11. | 197612 | 29.05.2014 |
| 12. | 199523 | 28.05.2014 |
| 13. | 213156 | 29.05.2014 |
| 14. | 239696 | 27.05.2014 |
| 15. | 243498 | 28.05.2014 |

REGISTRATION OF DESIGNS

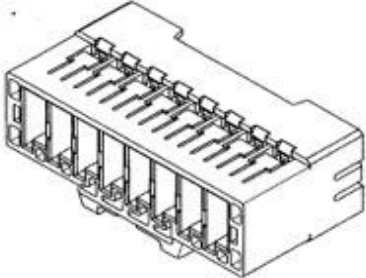

The following designs have been registered. They are now open for public inspection. In the following each entry the Date of Registration is shown. The Priority Number, Priority Date and Priority Country are also shown

| DESIGN NUMBER | 258585 | |  | | | | | |
|---|-------------------------|---------|---|------|---------|-------------|------------|-------|
| CLASS | 12-16 | | | | | | | |
| 1)DEERE & COMPANY, A US CORPORATION OF ONE JOHN DEERE PLACE, MOLINE, ILLINOIS, 61265-8098 USA | | | | | | | | |
| DATE OF REGISTRATION | 06/12/2013 | | | | | | | |
| TITLE | FUEL TANK FOR A VEHICLE | | | | | | | |
| PRIORITY NA | | | | | | | | |
| DESIGN NUMBER | 256371 | |  | | | | | |
| CLASS | 13-03 | | | | | | | |
| 1)YAZAKI CORPORATION, A JAPANESE CORPORATION OF 4-28, MITA 1-CHOME, MINATO-KU, TOKYO 108-8333 JAPAN | | | | | | | | |
| DATE OF REGISTRATION | 11/09/2013 | | | | | | | |
| TITLE | JOINT CONNECTOR | | | | | | | |
| PRIORITY | | | | | | | | |
| <table border="1" style="width: 100%; border-collapse: collapse;"> <thead> <tr> <th style="width: 30%;">PRIORITY NUMBER</th> <th style="width: 30%;">DATE</th> <th style="width: 40%;">COUNTRY</th> </tr> </thead> <tbody> <tr> <td>2013-005851</td> <td>15/03/2013</td> <td>JAPAN</td> </tr> </tbody> </table> | | | PRIORITY NUMBER | DATE | COUNTRY | 2013-005851 | 15/03/2013 | JAPAN |
| PRIORITY NUMBER | DATE | COUNTRY | | | | | | |
| 2013-005851 | 15/03/2013 | JAPAN | | | | | | |
| DESIGN NUMBER | 258651 | |  | | | | | |
| CLASS | 08-07 | | | | | | | |
| 1)GULMOHAR ENTEPRISES, 429, SHAHZADA BAGH, PHASE-1, NEW DELHI-110035, INDIA. (AN INDIAN PROPRIETORSHIP FIRM WHOSE PROPRIETOR IS:- ZIA UL HAQUE AN INDIAN NATIONAL OF THE ABOVE ADDRESS | | | | | | | | |
| DATE OF REGISTRATION | 10/12/2013 | | | | | | | |
| TITLE | SAFETY LOCK | | | | | | | |
| PRIORITY NA | | | | | | | | |

| | | |
|--|---------------------|--|
| DESIGN NUMBER | 257200 |  |
| CLASS | 15-02 | |
| 1)MEKO AUTO PVT. LTD., M-24, SECTOR-I, DSIDC, INDUSTRIAL AREA, BAWANA, DELHI-110039, INDIA, AN INDIAN COMPANY REGISTERED UNDER THE PROVISIONS OF INDIAN COMPANIES ACT, 1956, OF THE ABOVE ADDRESS | | |
| DATE OF REGISTRATION | 04/10/2013 | |
| TITLE | WATER PUMP ASSEMBLY | |
| PRIORITY NA | | |

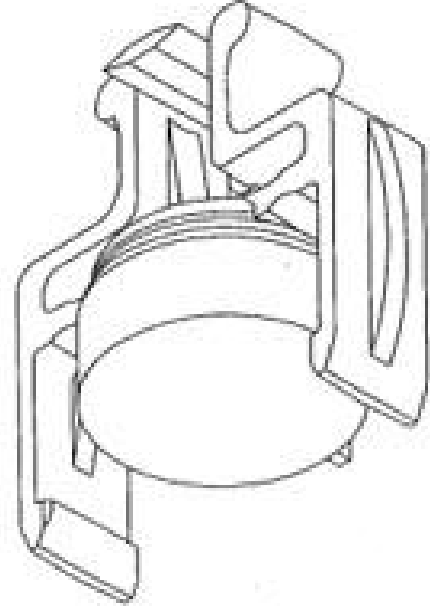
| | | |
|---|------------|---|
| DESIGN NUMBER | 254730 |  |
| CLASS | 07-99 | |
| 1)MA DESIGN PRIVATE LIMITED, A COMPANY INCORPORATED IN HAVING ITS PRINCIPAL PLACE OF BUSINESS AT A-41, SECTOR-80, PHASE-II, NOIDA-201305, U.P. INDIA | | |
| DATE OF REGISTRATION | 25/06/2013 | |
| TITLE | TRAY | |
| PRIORITY NA | | |

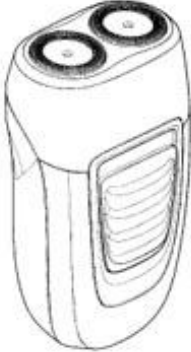
| | | | |
|---|---|---|----------------|
| DESIGN NUMBER | 253847 |  | |
| CLASS | 09-07 | | |
| 1)NORDSON CORPORATION, A CORPORATION ORGANIZED UNDER THE LAWS OF THE STATE OF OHIO OF 28601 CLEMENS ROAD, WESTLAKE, OHIO, 44145, USA | | | |
| DATE OF REGISTRATION | 15/05/2013 | | |
| TITLE | SEALING CAP FOR SNAP ENGAGEMENT DISPENSING ASSEMBLY | | |
| PRIORITY | | | |
| PRIORITY NUMBER | DATE | | COUNTRY |
| 29/437,504 | 16/11/2012 | | U.S.A. |



| | | | |
|---|--|----------------|---|
| DESIGN NUMBER | 256319 | |  |
| CLASS | 28-03 | | |
| 1)KONINKLIJKE PHILIPS N.V., A COMPANY ORGANIZED AND EXISTING UNDER THE LAWS OF THE KINGDOM OF THE NETHERLANDS, RESIDING AT EINDHOVEN, WHOSE POST-OFFICE ADDRESS IS HIGH TECH CAMPUS 5, 5656 AE EINDHOVEN, THE NETHERLANDS | | | |
| DATE OF REGISTRATION | 09/09/2013 | | |
| TITLE | TWO HEAD DRY SHAVER | | |
| PRIORITY | | | |
| PRIORITY NUMBER | DATE | COUNTRY | |
| 002211581-0001 | 28/03/2013 | OHIM | |
| DESIGN NUMBER | 255501 | |  |
| CLASS | 12-05 | | |
| 1)BHUPINDER SINGH, PROPRIETOR M/S E INDUSTRIES, LINK ROAD, MANSA DISTRICT MANSA, PIN-151505 (PUNJAB) INDIA, INDIAN NATIONAL | | | |
| DATE OF REGISTRATION | 25/07/2013 | | |
| TITLE | DRIVING PULLEY FOR VERTICAL CONNVEYOR OF HARVESTING REAPER | | |
| PRIORITY NA | | | |
| DESIGN NUMBER | 257740 | |  |
| CLASS | 12-16 | | |
| 1)DR. ING. H.C.F. PORSCHE AKTIENGESELLSCHAFT, A GERMAN COMPANY OF PORSCHEPLATZ 1, 70435 STUTTGART, GERMANY | | | |
| DATE OF REGISTRATION | 25/10/2013 | | |
| TITLE | WHEEL RIM | | |
| PRIORITY NA | | | |



| | | | |
|--|--------------------------------|----------------|---|
| DESIGN NUMBER | 258223 | |  |
| CLASS | 12-15 | | |
| 1)METRO TYRES LIMITED, A COMPANY INCORPORATED UNDER THE INDIAN COMPANIES ACT, 1956 NATIONALITY: INDIAN COMPANY, B-3 & B-4, SECTOR-58, NOIDA-201301, U.P. | | | |
| DATE OF REGISTRATION | 19/11/2013 | | |
| TITLE | TYRE | | |
| PRIORITY NA | | | |
| DESIGN NUMBER | 255377 | |  |
| CLASS | 12-15 | | |
| 1)SUMITOMO RUBBER INDUSTRIES, LTD. A COMPANY ORGANIZED UNDER THE LAWS OF JAPAN OF THE ADDRESS: 6-9, WAKINOHAMA-CHO 3-CHOME, CHUO-KU, KOBE-SHI, HYOGO 651-0072, JAPAN | | | |
| DATE OF REGISTRATION | 23/07/2013 | | |
| TITLE | TIRE FOR MOTORCYCLE | | |
| PRIORITY | | | |
| PRIORITY NUMBER | DATE | COUNTRY | |
| 2013-003145 | 18/02/2013 | JAPAN | |
| DESIGN NUMBER | 255024 | |  |
| CLASS | 04-02 | | |
| 1)KONINKLIJKE PHILIPS N.V., A COMPANY ORGANIZED AND EXISTING UNDER THE LAWS OF THE KINGDOM OF THE NETHERLANDS, RESIDING AT EINDHOVEN, WHOSE POST-OFFICE ADDRESS IS HIGH TECH CAMPUS 5, 5656 AE EINDHOVEN, THE NETHERLANDS | | | |
| DATE OF REGISTRATION | 05/07/2013 | | |
| TITLE | HANDLE FOR ELECTRIC TOOTHBRUSH | | |
| PRIORITY | | | |
| PRIORITY NUMBER | DATE | COUNTRY | |
| 002163675-0001 | 09/01/2013 | OHIM | |

| | | |
|---|---------------|--|
| DESIGN NUMBER | 245259 |  |
| CLASS | 11-01 | |
| 1)“DE BEERS CENTENARY AG OF ALPENSTRASSE 5, 6000 LUZERN 6, SWITZERLAND, A COMPANY INCORPORATED UNDER SWITZERLAND LAWS | | |
| DATE OF REGISTRATION | 11/05/2012 | |
| TITLE | EARRING | |
| PRIORITY NA | | |
| DESIGN NUMBER | 253166 |  |
| CLASS | 07-02 | |
| 1)NARENDIRAN REDDY SIMMACHALAM S/O SIMMACHALAM REDDY RAMASWAMY AGED ABOUT 36 YEARS, INDIAN HAVING OFFICE AT 12/379, 13TH CROSS STREET, PHASE-1, SATHUVACHARI, VELLORE-632009, INDIA | | |
| DATE OF REGISTRATION | 15/04/2013 | |
| TITLE | COOKING PLATE | |
| PRIORITY NA | | |
| DESIGN NUMBER | 258547 |  |
| CLASS | 07-02 | |
| 1)HAMILTON HOUSEWARES PVT. LTD. AN INDIAN COMPANY INCORPORATED UNDER THE COMPANIES ACT 1956, HAVING REGISTERED OFFICE AT KAISER-I-HIND BLDG., 3RD FLOOR, CURRIMBOY ROAD, BALLARD ESTATE, MUMBAI 400001, MAHARASHTRA, INDIA | | |
| DATE OF REGISTRATION | 03/12/2013 | |
| TITLE | CASSEROLE | |
| PRIORITY NA | | |

| | | | |
|---|--------------|----------------|---|
| DESIGN NUMBER | 253433 | |  |
| CLASS | 23-01 | | |
| 1)MR. NARASHIHA S. BHOYA, INDIAN NATIONAL, CARRYING ON BUSINESS AS A PROPRIETOR UNDER THE NAME AND STYLE OF M/S NARASHIHA SWIMMING POOL CONSTRUCTIONS HAVING ITS PRINCIPAL PLACE OF BUSINESS ADDRESS | | | |
| AT H. NO. 14/2, SORVE GUIRIM, MAPUSA, GOA-403507 | | | |
| DATE OF REGISTRATION | 26/04/2013 | | |
| TITLE | WATER FILTER | | |
| PRIORITY NA | | | |
| DESIGN NUMBER | 257613 | |  |
| CLASS | 08-06 | | |
| 1)RAJESHBHAI TULSHIBHAI KIYADA AN INDIAN NATIONAL SOLE PROPRIETOR OF NATRAJ TECHNOCAST AN INDIAN PROPRIETORSHIP FIRM HAVING ITS PRINCIPAL PLACE OF BUSINESS AT | | | |
| NEAR POLYTECHNIC HOSTEL, B/H K. S. DIESEL, 12-AJI VASAHAHAT, RAJKOT-360 003, GUJARAT-INDIA | | | |
| DATE OF REGISTRATION | 21/10/2013 | | |
| TITLE | HANDLE | | |
| PRIORITY NA | | | |
| DESIGN NUMBER | 258786 | |  |
| CLASS | 04-02 | | |
| 1)COLGATE-PALMOLIVE COMPANY, A DELAWARE CORPORATION, 300 PARK AVENUE, NEW YORK, NEW YORK 10022, UNITED STATES OF AMERICA | | | |
| DATE OF REGISTRATION | 17/12/2013 | | |
| TITLE | TOOTHBRUSH | | |
| PRIORITY | | | |
| PRIORITY NUMBER | DATE | COUNTRY | |
| 29/461,011 | 17/07/2013 | U.S.A. | |

| | | | |
|--|-----------------------------------|----------------|---|
| DESIGN NUMBER | 255099 | |  |
| CLASS | 26-99 | | |
| 1)SANJEEV. K (INDIAN), RESIDING AT: VETIKATIL HOUSE, KANJIRAPUZA, MANNARKAD, PALAKKAD(DIST), KERALA, INDIA | | | |
| DATE OF REGISTRATION | 10/07/2013 | | |
| TITLE | HOLDER DECORE PLATE | | |
| PRIORITY NA | | | |
| DESIGN NUMBER | 245287 | |  |
| CLASS | 11-01 | | |
| 1)'DE BEERS CENTENARY AG OF ALPENSTRASSE 5, 6000 LUZERN 6, SWITZERLAND, A COMPANY INCORPORATED UNDER SWITZERLAND LAWS | | | |
| DATE OF REGISTRATION | 14/05/2012 | | |
| TITLE | RING | | |
| PRIORITY NA | | | |
| DESIGN NUMBER | 257599 | |  |
| CLASS | 12-16 | | |
| 1)HONDA MOTOR CO., LTD., A JAPANESE CORPORATION, OF 1-1, MINAMI-AOYAMA 2-CHOME, MINATO-KU, TOKYO, JAPAN | | | |
| DATE OF REGISTRATION | 21/10/2013 | | |
| TITLE | FRONT TOP COVER FOR MOTOR SCOOTER | | |
| PRIORITY | | | |
| PRIORITY NUMBER | DATE | COUNTRY | |
| 2013-009568 | 26/04/2013 | JAPAN | |



| | | | |
|--|---------------|----------------|---|
| DESIGN NUMBER | 257741 | |  |
| CLASS | 12-16 | | |
| 1)DR. ING. H.C.F. PORSCHE AKTIENGESELLSCHAFT, A GERMAN COMPANY OF PORSCHPLATZ 1, 70435 STUTTGART, GERMANY | | | |
| DATE OF REGISTRATION | 25/10/2013 | | |
| TITLE | WHEEL RIM | | |
| PRIORITY NA | | | |
| DESIGN NUMBER | 258672 | |  |
| CLASS | 31-00 | | |
| 1)KONINKLIJKE PHILIPS N.V., A DUTCH COMPANY HAVING A PLACE OF BUSINESS AT HIGH TECH CAMPUS 5, EINDHOVEN 5656 AE, NETHERLANDS | | | |
| DATE OF REGISTRATION | 11/12/2013 | | |
| TITLE | MIXER GRINDER | | |
| PRIORITY NA | | | |
| DESIGN NUMBER | 258785 | |  |
| CLASS | 04-02 | | |
| 1)COLGATE-PALMOLIVE COMPANY, A DELAWARE CORPORATION, 300 PARK AVENUE, NEW YORK, NEW YORK 10022, UNITED STATES OF AMERICA | | | |
| DATE OF REGISTRATION | 17/12/2013 | | |
| TITLE | TOOTHBRUSH | | |
| PRIORITY | | | |
| PRIORITY NUMBER | DATE | COUNTRY | |
| 29/461,011 | 17/07/2013 | U.S.A. | |

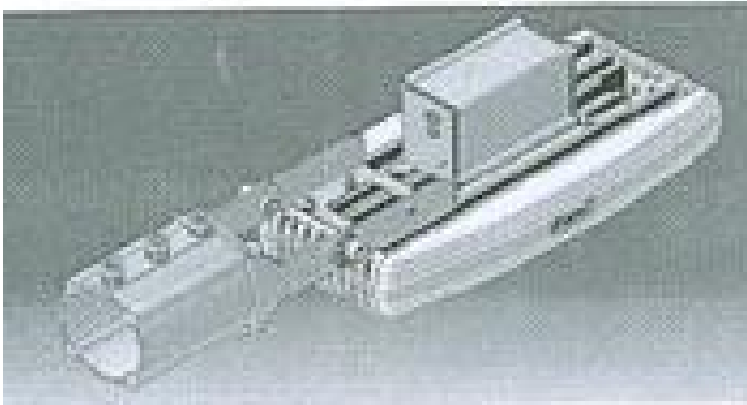

| | | | |
|---|-------------------------|----------------|---|
| DESIGN NUMBER | 255064 | |  |
| CLASS | 14-02 | | |
| 1)BLACK PEARL SYSTEMS, INC. A COMPANY INCORPORATED UNDER THE LAWS OF USA, HAVING ITS OFFICE AT 10001 DE ANZA BLVD. SUITE 300, CUPERTINO, CALIFORNIA 95014, USA | | | |
| DATE OF REGISTRATION | 08/07/2013 | | |
| TITLE | STORAGE DEVICE BACKPACK | | |
| PRIORITY | | | |
| PRIORITY NUMBER | DATE | COUNTRY | |
| 29/441,688 | 08/01/2013 | U.S.A. | |
| DESIGN NUMBER | 245286 | |  |
| CLASS | 11-01 | | |
| 1)“DE BEERS CENTENARY AG OF ALPENSTRASSE 5, 6000 LUZERN 6, SWITZERLAND, A COMPANY INCORPORATED UNDER SWITZERLAND LAWS | | | |
| DATE OF REGISTRATION | 14/05/2012 | | |
| TITLE | RING | | |
| PRIORITY NA | | | |
| DESIGN NUMBER | 258528 | |  |
| CLASS | 26-05 | | |
| 1)PHOTOQUIP INDIA LTD., A-33, ROYAL INDUSTRIAL ESTATE, NAIGAON CROSS ROAD, WADALA, MUMBAI-400031, STATE OF MAHARASHTRA, INDIA, / A LIMITED COMPANY INCORPORATED UNDER INDIAN COMPANIES ACT., ABOVE ADDRESS | | | |
| DATE OF REGISTRATION | 03/12/2013 | | |
| TITLE | DOWN LIGHT | | |
| PRIORITY NA | | | |



| | | |
|---|----------------------|--|
| DESIGN NUMBER | 256223 |  |
| CLASS | 26-03 | |
| 1)NTL ELECTRONICS INDIA LTD., AN INDIAN COMPANY OF THE ADDRESS GURU AMAR DASS, BHAWAN, 78, NEHRU PLACE, NEW DELHI-110019, INDIA | | |
| DATE OF REGISTRATION | 05/09/2013 | |
| TITLE | STREET LIGHT FIXTURE | |
| PRIORITY NA | | |

| | | |
|--|------------|--|
| DESIGN NUMBER | 258217 |  |
| CLASS | 09-01 | |
| 1)CROP LIFE SCIENCE LTD, INDIAN COMPANY, REGISTERED UNDER THE PROVISIONS OF COMPANIES ACT, 1956, HAVING REGISTERED OFFICE IS 209, 'PRIMATE' NR. JUDGES BUNGLOW CROSS ROAD, BODAKDEV, AHMEDABAD-380 015. GUJARAT, INDIA | | |
| DATE OF REGISTRATION | 19/11/2013 | |
| TITLE | BOTTLE | |
| PRIORITY NA | | |

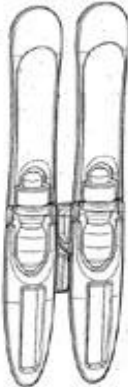
| | | |
|---|-------------|--|
| DESIGN NUMBER | 258728 |  |
| CLASS | 04-04 | |
| 1)SIDDHANT BRUSH INDUSTRIES ADDRESS ARYA NAGAR, NEAR MANSAROVER, RAM GANGA MANDIR KE BARABAR, RAMGHAT ROAD, ALIGARH (U.P.)-202001 AND NATIONALITY INDIAN. | | |
| DATE OF REGISTRATION | 13/12/2013 | |
| TITLE | PAINT BRUSH | |
| PRIORITY NA | | |

| | | |
|--|---------------------|---|
| DESIGN NUMBER | 258849 |  |
| CLASS | 08-06 | |
| 1)RASIKLAL GHUSABHAI CHO VATIYA (ADULT & INDIAN NATIONAL) SOLE PROPRIETOR OF M K TECHNOCAST (INDIAN PROPRIETORSHIP CONCERN) HAVING PLACE OF BUSINESS AT-2, PATEL NAGAR, SADBHAVNA, PLOT, NR: BHAGWATI ENTERPRISE, 50, FEET MAIN ROAD, RAJKOT-GUJARAT-(INDIA) | | |
| DATE OF REGISTRATION | 19/12/2013 | |
| TITLE | HANDLE | |
| PRIORITY NA | | |
| DESIGN NUMBER | 257209 |  |
| CLASS | 15-02 | |
| 1)MEKO AUTO PVT. LTD., M-24, SECTOR-I, DSIDC, INDUSTRIAL AREA, BAWANA, DELHI-110039, INDIA, AN INDIAN COMPANY REGISTERED UNDER THE PROVISIONS OF INDIAN COMPANIES ACT, 1956, OF THE ABOVE ADDRESS | | |
| DATE OF REGISTRATION | 04/10/2013 | |
| TITLE | WATER PUMP ASSEMBLY | |
| PRIORITY NA | | |
| DESIGN NUMBER | 258559 |  |
| CLASS | 26-05 | |
| 1)NATIONAL INSTITUTE OF DESIGN LOCATED AT PALDI, AHMEDABAD-380007, GUJARAT, HAVING NATIONALITY AS INDIAN | | |
| DATE OF REGISTRATION | 05/12/2013 | |
| TITLE | TUBE LAMP HOLDER | |
| PRIORITY NA | | |

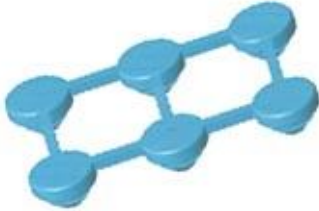
| | | | |
|--|-------------------------------|----------------|---|
| DESIGN NUMBER | 255535 | |  |
| CLASS | 23-01 | | |
| 1)VICTOR EQUIPMENT COMPANY, 2800 AIRPORT ROAD, DENTON, TEXAS 76207, U.S.A. | | | |
| DATE OF REGISTRATION | 29/07/2013 | | |
| TITLE | GAS PRESSURE REGULATOR | | |
| PRIORITY | | | |
| PRIORITY NUMBER | DATE | COUNTRY |  |
| 29/444,304 | 29/01/2013 | U.S.A. | |
| DESIGN NUMBER | 253576 | | |
| CLASS | 24-01 | | |
| 1)ALLERGAN, INC., 2525 DUPONT DRIVE, IRVINE, CALIFORNIA 92612, U.S.A. | | | |
| DATE OF REGISTRATION | 30/04/2013 | | |
| TITLE | UNIT DOSE VIAL (SET) | | |
| PRIORITY NA | | |  |
| DESIGN NUMBER | 257372 | | |
| CLASS | 02-06 | | |
| 1)SAMEER BHAUSAHEB SHINDE AN INDIAN NATIONAL WHOSE ADDRESS IS KUSUM NIVAS, SURVEY NO. 56/2/1, LANE NO. 1, KAWADE NAGAR, OPPOSITE TO MAYUR NAGRI PHASE-I, PIMPLE GURAV, PUNE 411027 MAHARASHTRA, INDIA | | | |
| DATE OF REGISTRATION | 09/10/2013 | | |
| TITLE | MITTEN SCRUBBING GLOVES (SET) | | |
| PRIORITY NA | | | |



| | | |
|---|---------------------------------|--|
| DESIGN NUMBER | 250142 |  |
| CLASS | 09-04 | |
| 1)TOPLAND ENGINES PVT. LTD. (A COMPANY INCORPORATED UNDER THE COMPANIES ACT, 1956) HAVING ITS REGISTERED OFFICE AT 2, UMAKANT PANDIT, UDYOGNAGAR, MAVDI PLOT, RAJKOT-360004 (GUJARAT), INDIA, INDIAN COMPANY | | |
| DATE OF REGISTRATION | 13/12/2012 | |
| TITLE | CRATE | |
| PRIORITY NA | | |
| DESIGN NUMBER | 258628 |  |
| CLASS | 12-16 | |
| 1)TATA MOTORS LIMITED, AN INDIAN COMPANY OF BOMBAY HOUSE, 24 HOMI MODY STREET, HUTATMA CHOWK, MUMBAI 400001, MAHARASHTRA, INDIA | | |
| DATE OF REGISTRATION | 09/12/2013 | |
| TITLE | PEDAL PLATE COVER OF AUTOMOBILE | |
| PRIORITY NA | | |
| DESIGN NUMBER | 259044 |  |
| CLASS | 06-04 | |
| 1)GODREJ & BOYCE MFG. CO. LTD., AN INDIAN COMPANY INCORPORATED UNDER THE COMPANIES ACT, 1913, OF GODREJ INTERIO, PLANT 4, PIROJSHANAGER, VIKHROLI (WEST), MUMBAI-400079, INDIA | | |
| DATE OF REGISTRATION | 27/12/2013 | |
| TITLE | STORAGE FURNITURE | |
| PRIORITY NA | | |

| | | |
|---|------------------------------|---|
| DESIGN NUMBER | 257571 |  |
| CLASS | 23-01 | |
| 1)MR. KRISHENLAL KHANNA, INDIAN NATIONAL ON BEHALF OF KIMPLAS PIPING SYSTEMS LTD., A FIRM HAVING ITS PRINCIPAL PLACE OF BUSINESS ADDRESS AT B-20, MIDC, AMBAD, NASHIK-422010 | | |
| DATE OF REGISTRATION | 21/10/2013 | |
| TITLE | FLUID DISTRIBUTION EQUIPMENT | |
| PRIORITY NA | | |

| | | |
|---|------------|--|
| DESIGN NUMBER | 258222 |  |
| CLASS | 12-15 | |
| 1)METRO TYRES LIMITED, A COMPANY INCORPORATED UNDER THE INDIAN COMPANIES ACT, 1956 NATIONALITY: INDIAN COMPANY, B-3 & B-4, SECTOR-58, NOIDA-201301, U.P. | | |
| DATE OF REGISTRATION | 19/11/2013 | |
| TITLE | TYRE | |
| PRIORITY NA | | |

| | | |
|--|-------------|---|
| DESIGN NUMBER | 257255 |  |
| CLASS | 12-08 | |
| 1)VOLVO LASTVAGNAR AB, OF 405 08 GÖTEBORG, SWEDEN | | |
| DATE OF REGISTRATION | 08/10/2013 | |
| TITLE | VEHICLE CAB | |
| PRIORITY | | |
| PRIORITY NUMBER | DATE | COUNTRY |
| 002219469-0001 | 12/04/2013 | OHIM |

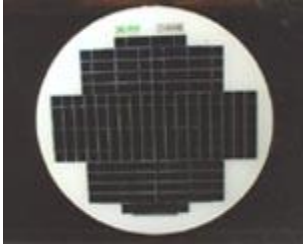
| | | |
|--|---------------------------------------|---|
| DESIGN NUMBER | 257373 |  |
| CLASS | 23-01 | |
| 1)BAJAJ ELECTRICALS LIMITED, A COMPANY REGISTERED IN INDIA, HAVING ITS REGISTERED OFFICE AT, 45/47, VEER NARIMAN ROAD, MUMBAI 400023, STATE OF MAHARASHTRA, INDIA, OF ABOVE ADDRESS | | |
| DATE OF REGISTRATION | 10/10/2013 | |
| TITLE | WATER PURIFIER | |
| PRIORITY NA | | |
| DESIGN NUMBER | 258039 |  |
| CLASS | 09-01 | |
| 1)WEENER EMPIRE PLASTICS LTD., (AN INDIAN PRIVATE LIMITED COMPANY REGISTERED UNDER THE INDIAN COMPANIES ACT, 1956), OF 19/A MIRA CO-OP. INDUSTRIAL ESTATE, WESTERN EXPRESS HIGHWAY, OPP. AMAR PALACE HOTEL, MIRA ROAD, THANE-401104, MAHARASHTRA, INDIA | | |
| DATE OF REGISTRATION | 08/11/2013 | |
| TITLE | BOTTLE | |
| PRIORITY NA | | |
| DESIGN NUMBER | 254282 |  |
| CLASS | 12-16 | |
| 1)RENAULT TRUCKS, A COMPANY ORGANIZED UNDER THE LAWS OF FRANCE, OF 99 ROUTE DE LYON, 69800 SAINT PRIEST, FRANCE | | |
| DATE OF REGISTRATION | 06/06/2013 | |
| TITLE | FRAME COMPONENT FOR VEHICLE HEADLIGHT | |
| PRIORITY NA | | |

| | | |
|--|-------------------|---|
| DESIGN NUMBER | 254861 |  |
| CLASS | 26-03 | |
| 1)(1)FALGUN DEVENDRABHAI BHATT (2) SMT. RUJAL FALGUN BHATT BOTH INDIAN NATIONAL AND PARTNERS OF NEETY EURO ASIA SOLAR ENERGY (A PARTNERSHIP FIRM) HAVING THEIR PLACE OF BUSINESS AT BUNGLOW NO. 4, SHREE NAGAR SOCIETY, OPP. GOLDEN TRIANGLE, S.P. STADIUM ROAD, AHMEDABAD-380014 GUJARAT (INDIA) | | |
| DATE OF REGISTRATION | 28/06/2013 | |
| TITLE | SOLAR PANEL | |
| PRIORITY NA | | |
| DESIGN NUMBER | 258497 |  |
| CLASS | 02-04 | |
| 1)JOSE JOSEPH, MAXY JOSEPH, SONIA TONY AND ABEY JOSEPH, TRADING IN PARTNERSHIP AS M/S. JOSCO RUBBERS, AT 8/50, MOONALINGAL, OPP. TO FIRE STATION, CALICUT-673 032, KERALA, INDIA | | |
| DATE OF REGISTRATION | 29/11/2013 | |
| TITLE | STUD FOR FOOTWEAR | |
| PRIORITY NA | | |
| DESIGN NUMBER | 258520 |  |
| CLASS | 08-06 | |
| 1)JITESH KANTILAL GADA, INDIAN NATIONALS, PROPRIETOR OF OSWAL HARDWARE, INDIAN NATIONAL, 107, KESHAVJI NAYAK ROAD, HINGWALA BLDG., ROOM NO. 43/44, 4TH FLOOR, MASJID BUNDER, MUMBAI-400 009, INDIA ALL INDIAN OF ABOVE ADDRESS | | |
| DATE OF REGISTRATION | 02/12/2013 | |
| TITLE | HANDLE | |
| PRIORITY NA | | |



| | | |
|---|---------------------|---|
| DESIGN NUMBER | 257549 |  |
| CLASS | 26-03 | |
| 1)NITIN R. SHENOY, INDIAN NATIONAL, 602, JALTARANG, LOKPURAM, DR. GLADYS ALVARES ROAD, OFF. POKHRAN ROAD NO. 2, THANE (W)-400 601, MAHARASHTRA, INDIA. | | |
| DATE OF REGISTRATION | 17/10/2013 | |
| TITLE | LIGHTING FIXTURE | |
| PRIORITY NA | | |
| DESIGN NUMBER | 258716 |  |
| CLASS | 12-15 | |
| 1)COMPAGNIE GENERALE DES ETABLISSEMENTS MICHELIN, A FRENCH COMPANY OF 12 COURS SABLON, F-63000, CLERMONT-FERRAND, FRANCE, AND MICHELIN RECHERCHE ET TECHNIQUE S.A., A SWISS COMPANY OF ROUTE LOUIS BRAILLE 10 - CH-1763 GRANGES-PACCOT, SWITZERLAND | | |
| DATE OF REGISTRATION | 13/12/2013 | |
| TITLE | TIRE | |
| PRIORITY NA | | |
| DESIGN NUMBER | 257201 |  |
| CLASS | 15-02 | |
| 1)MEKO AUTO PVT. LTD., M-24, SECTOR-I, DSIDC, INDUSTRIAL AREA, BAWANA, DELHI-110039, INDIA, AN INDIAN COMPANY REGISTERED UNDER THE PROVISIONS OF INDIAN COMPANIES ACT, 1956, OF THE ABOVE ADDRESS | | |
| DATE OF REGISTRATION | 04/10/2013 | |
| TITLE | WATER PUMP ASSEMBLY | |
| PRIORITY NA | | |



| | | |
|--|-------------------|---|
| DESIGN NUMBER | 258908 |  |
| CLASS | 23-01 | |
| 1)ONKAR TIWARI (DIRECTOR), NATIONALITY INDIAN, TRADING AS ASHWATH INFRA TECH PVT. LTD. (INDIAN) WHOES ADDRESS IS 1ST FLOOR, 29, COMMUNITY CENTRE, EAST OF KAILASH, NEW DELHI-110065 (INDIA) | | |
| DATE OF REGISTRATION | 23/12/2013 | |
| TITLE | RAIN WATER FILTER | |
| PRIORITY NA | | |

| | | |
|---|------------|--|
| DESIGN NUMBER | 257795 |  |
| CLASS | 08-08 | |
| 1)(1) MEHULBHAI D. CHAVDA (2) SOMESHBHAI S. MALIK AND (3) DHIRENBHAI SHAH ALL INDIAN NATIONAL PARTNER OF DMS ARCHITECTURAL PRODUCTS AN INDIAN PARTNERSHIP FIRM HAVING ITS PRINCIPAL PLACE OF BUSINESS AT ADDRESS: PLOT NO. 6, SURVEY NO. 20, EVEREST INDUSTRIAL AREA, NEAR PERFECT (TATA) SHOWROOM, NATIONAL HIGHWAY NO. 8-B, VAVDI-DIST. RAJKOT-360004, GUJARAT-INDIA | | |
| DATE OF REGISTRATION | 28/10/2013 | |
| TITLE | HOOK | |
| PRIORITY NA | | |

| | | |
|---|-------------|--|
| DESIGN NUMBER | 255583 |  |
| CLASS | 14-99 | |
| 1)MODERN COMMUNICATION & BROADCAST SYSTEMS PVT. LTD., B-138/139, G.I.D.C. ELECTRONICS ESTATE, SECTOR-25, GANDHINAGAR-382024. (GUJARAT) (INDIA) | | |
| DATE OF REGISTRATION | 01/08/2013 | |
| TITLE | SET TOP BOX | |
| PRIORITY NA | | |

| | | |
|--|-------------------|---|
| DESIGN NUMBER | 257691 |  |
| CLASS | 08-06 | |
| 1)(1) RUPESHBHAI MANSUKHBHAI MANSARA (2) JAYESHBHAI GOBARBHAI SHEKHALIYA (3) CHETANBHAI LAVJIBHAI SINGHALA (ALL THE PARTNERS ARE ADULT & INDIAN NATIONAL) PARTNERS OF JAY SOMNATH METAL (INDIAN PARTNERSHIP FIRM) HAVING PLACE OF BUSINESS AT: 3, MARUTI INDUSTRIAL AREA, KOTHARIYA RING ROAD, B/H. MURLIDHAR WAYBRIDGE, N.H. 8B, RAJKOT-360 003-GUJARAT-(INDIA) | | |
| DATE OF REGISTRATION | 24/10/2013 | |
| TITLE | HANDLE | |
| PRIORITY NA | | |
| DESIGN NUMBER | 257760 |  |
| CLASS | 12-05 | |
| 1)JCB INDIA LIMITED, AN INDIAN COMPANY HAVING ITS REGISTERED OFFICE AT B-1/1-1, 2ND FLOOR, MOHAN CO-OPERATIVE INDUSTRIAL ESTATE, MATHURA ROAD, NEW DELHI, INDIA AND WORKS AT 23/7, MATHURA ROAD, BALLABGARH, HARYANA, INDIA | | |
| DATE OF REGISTRATION | 25/10/2013 | |
| TITLE | SKID STEER LOADER | |
| PRIORITY NA | | |
| DESIGN NUMBER | 258700 |  |
| CLASS | 09-01 | |
| 1)JOYFUL PLASTICS PRIVATE LIMITED, A COMPANY REGISTERED IN INDIA, HAVING ITS REGISTERED OFFICE AT 15, A/F, NEW EMPIRE INDUSTRIAL ESTATE, KONDIVITA ROAD, J.B. NAGAR, ANDHERI (E), MUMBAI-400059, STATE OF MAHARASHTRA, INDIA, OF ABOVE ADDRESS | | |
| DATE OF REGISTRATION | 12/12/2013 | |
| TITLE | BOTTLE | |
| PRIORITY NA | | |

| | | | |
|--|---|----------------|---|
| DESIGN NUMBER | 257184 | |  |
| CLASS | 24-01 | | |
| 1)M/S. PREGNA INTERNATIONAL LIMITED, A COMPANY INCORPORATED UNDER THE COMPANIES ACT 1956 IN INDIA AND HAVING ITS REGISTERED ADDRESS AT 13, SURYODAY ESTATE, 136 TARDEO ROAD, MUMBAI-400034, MAHARASHTRA, INDIA | | | |
| DATE OF REGISTRATION | 04/10/2013 | | |
| TITLE | UTERINE SOUNDING APPARATUS FOR MEDICAL PURPOSES | | |
| PRIORITY NA | | | |
| DESIGN NUMBER | 254673 | |  |
| CLASS | 12-07 | | |
| 1)DUTERTRE XAVIER, GILBERT, MARC, A FRENCH CITIZEN OF THE ADDRESS 4 BIS, CHEMIN DU PLESSIS, 27180 LE-PLESSIS-GROHAN, FRANCE | | | |
| DATE OF REGISTRATION | 21/06/2013 | | |
| TITLE | AEROPLANE | | |
| PRIORITY | | | |
| PRIORITY NUMBER | DATE | COUNTRY | |
| 12/5770 | 27/12/2012 | FRANCE | |
| DESIGN NUMBER | 258551 | |  |
| CLASS | 15-03 | | |
| 1)CHAANY AGRO INDUSTRIES OF SIRYEWALA, TEHSIL PHUL, DIST. BATHINDA-151206 (PUNJAB) INDIA, AN INDIAN PARTNERSHIP FIRM, WHOSE PARTNERS ARE SARDAR GUETEJ SINGH & SARDAR TARLOCHAN SINGH INDIAN NATIONALS OF ABOVE ADDRESS | | | |
| DATE OF REGISTRATION | 04/12/2013 | | |
| TITLE | PADDY STRAW CHOPPER SHREDDER | | |
| PRIORITY NA | | | |

| | | | |
|--|--------------------------|-------------------|---|
| DESIGN NUMBER | 253487 | |  |
| CLASS | 31-00 | | |
| 1)KONINKLIJKE PHILIPS ELECTRONICS N.V., A COMPANY ORGANIZED AND EXISTING UNDER THE LAWS OF THE KINGDOM OF THE NETHERLANDS, RESIDING AT EINDHOVEN, WHOSE POST-OFFICE ADDRESS IS HIGH TECH CAMPUS 5, 5656 AE EINDHOVEN, THE NETHERLANDS | | | |
| DATE OF REGISTRATION | 29/04/2013 | | |
| TITLE | NOODLE/PASTA MAKER | | |
| PRIORITY | | | |
| PRIORITY NUMBER | DATE | COUNTRY | |
| 002128892-0001 | 31/10/2012 | OHIM | |
| DESIGN NUMBER | 255695 | |  |
| CLASS | 20-01 | | |
| 1)NAUTILUS HYOSUNG INC. NATIONALITY: KOREA, ADDRESS AT 281 GWANGPYEONG-RO, GANGNAM-GU, SEOUL, KOREA | | | |
| DATE OF REGISTRATION | 07/08/2013 | | |
| TITLE | AUTOMATED TELLER MACHINE | | |
| PRIORITY | | | |
| PRIORITY NUMBER | DATE | COUNTRY | |
| 30-2013-0008133 | 15/02/2013 | REPUBLIC OF KOREA | |
| DESIGN NUMBER | 258678 | |  |
| CLASS | 19-06 | | |
| 1)S. S. B. METAL WORKS, K. YUNUS BLDG., 2ND FLOOR, VISHWESHWAR NAGAR ROAD, OFF. AAREY ROAD, GOREGAON (E), MUMBAI - 400063, STATE OF MAHARASHTRA, (INDIA), INDIAN PARTNERSHIP FIRM, INDIAN NATIONALS WHOSE PARTNERS ARE:- 1. BHARAT JETHMAL LUNIA (2) PRAVIN JETHMAL LUNIA INDIAN NATIONAL, OF ABOVE ADDRESS | | | |
| DATE OF REGISTRATION | 12/12/2013 | | |
| TITLE | BALL POINT PEN | | |
| PRIORITY NA | | | |

| | | |
|---|---------------|--|
| DESIGN NUMBER | 253987 |  |
| CLASS | 06-04 | |
| 1)MR. NEERAJ KUMAR, A INDIAN CITIZEN, PROPRIETOR OF SHEETAL ENTERPRISES, A INDIAN PROPRIETORSHIP COMPANY OF PLOT NO-58, NAWADA VILLAGE, UTTAM NAGAR, DELHI-110059, INDIA | | |
| DATE OF REGISTRATION | 20/05/2013 | |
| TITLE | KITCHEN STAND | |
| PRIORITY NA | | |

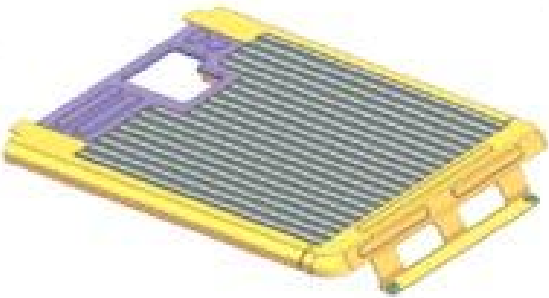

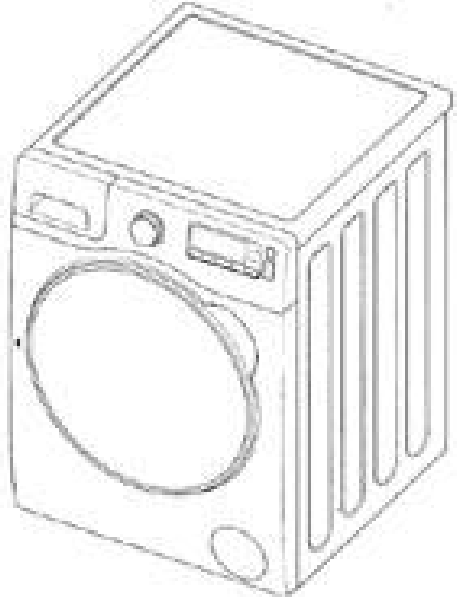
| | | |
|--|----------------------------------|---|
| DESIGN NUMBER | 257761 |  |
| CLASS | 12-16 | |
| 1)JCB INDIA LIMITED, AN INDIAN COMPANY HAVING ITS REGISTERED OFFICE AT B-1/1-1, 2ND FLOOR, MOHAN CO-OPERATIVE INDUSTRIAL ESTATE, MATHURA ROAD, NEW DELHI, INDIA AND WORKS AT 23/7, MATHURA ROAD, BALLABGARH, HARYANA, INDIA | | |
| DATE OF REGISTRATION | 25/10/2013 | |
| TITLE | TOP GRILLE FOR SKID STEER LOADER | |
| PRIORITY NA | | |

| | | | |
|---|-----------------|-------------------|---|
| DESIGN NUMBER | 258701 | |  |
| CLASS | 15-05 | | |
| 1)SAMSUNG ELECTRONICS CO., LTD. 129, SAMSUNG-RO, YEONGTONG-GU, SUWON-SI, GYEONGGI-DO, 443-742, REPUBLIC OF KOREA, A COMPANY OF REPUBLIC OF KOREA | | | |
| DATE OF REGISTRATION | 12/12/2013 | | |
| TITLE | WASHING MACHINE | | |
| PRIORITY | | | |
| PRIORITY NUMBER | DATE | COUNTRY | |
| 30-2013-0044729 | 30/08/2013 | REPUBLIC OF KOREA | |
| PRIORITY NA | | | |

| | | | |
|---|-------------|----------------|---|
| DESIGN NUMBER | 257190 | |  |
| CLASS | 13-02 | | |
| 1)SMA SOLAR TECHNOLOGY AG, A GERMAN COMPANY OF SONNENALLEE 1, 34266 NIESTETAL, GERMANY | | | |
| DATE OF REGISTRATION | 04/10/2013 | | |
| TITLE | INVERTER | | |
| PRIORITY | | | |
| PRIORITY NUMBER | DATE | COUNTRY | |
| 002255380-0002 | 14/06/2013 | OHIM | |
| | | | |

| | | | |
|---|------------|--|---|
| DESIGN NUMBER | 257687 | |  |
| CLASS | 08-06 | | |
| 1)JAYESHBHAI DINESHBHAI SOJITRA (ADULT & INDIAN NATIONAL) SOLE PROPRIETOR OF BALAJI INDUSTRIES (INDIAN PROPRIETORSHIP FIRM) HAVING PLACE OF BUSINESS AT : VIRANI AGHAT, GHANSHYAMNAGAR-5 CORNER, OPP: PAVAN INDUSTRIES, DHEBAR ROAD, SOUTH, RAJKOT-GUJARAT (INDIA) | | | |
| DATE OF REGISTRATION | 24/10/2013 | | |
| TITLE | HANDLE | | |
| PRIORITY NA | | | |

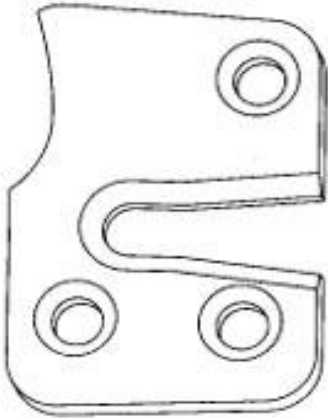
| | | | |
|---|-------------------------------|----------------|---|
| DESIGN NUMBER | 257351 | |  |
| CLASS | 13-01 | | |
| 1)WOBBEN PROPERTIES GMBH, A CORPORATION ORGANIZED AND EXISTING UNDER THE LAWS OF GERMANY, OF DREEKAMP 5, 26605 AURICH, GERMANY | | | |
| DATE OF REGISTRATION | 09/10/2013 | | |
| TITLE | ROTOR BLADE OF A WIND TURBINE | | |
| PRIORITY | | | |
| PRIORITY NUMBER | DATE | COUNTRY | |
| 002218164-0001 | 11/04/2013 | OHIM | |

| | | |
|--|------------------------------|---|
| DESIGN NUMBER | 257176 |  |
| CLASS | 08-06 | |
| 1)DIVYESHBHAI G BARASIYA (INDIAN NATIONALS) SOLE PROPRIETOR OF SHREE TECHNOCAST (INDIAN PROPRIETORSHIP CONCERN) HAVING PLACE OF BUSINESS AT - SHED NO. K-1, 242/5, AJI GIDC ROAD, Q-2, MELTECH, NR. TERBO BEARING, RAJKOT-360003-GUJARAT (INDIA) | | |
| DATE OF REGISTRATION | 04/10/2013 | |
| TITLE | HANDLE | |
| PRIORITY NA | | |
| DESIGN NUMBER | 259046 |  |
| CLASS | 12-16 | |
| 1)TATA MOTORS LIMITED, AN INDIAN COMPANY OF BOMBAY HOUSE, 24 HOMI MODY STREET, HUTATMA CHOWK, MUMBAI 400 001, MAHARASHTRA, INDIA | | |
| DATE OF REGISTRATION | 27/12/2013 | |
| TITLE | DOOR SIDE GUIDE FOR VEHICLES | |
| PRIORITY NA | | |
| DESIGN NUMBER | 255383 |  |
| CLASS | 23-04 | |
| 1)HAVELLS INDIA LIMITED HAVING REGISTERED OFFICE AT 1, RAJ NARAIN MARG, CIVIL LINES, DELHI 110054. | | |
| DATE OF REGISTRATION | 23/07/2013 | |
| TITLE | FAN | |
| PRIORITY NA | | |

| | | | |
|--|----------------------------------|----------------|--|
| DESIGN NUMBER | 255532 | |  |
| CLASS | 15-03 | | |
| 1)INTERPULS S.P.A., AN ITALIAN JOINT STOCK COMPANY OF VIA F. MARITANO, 11, 42020 ALBINEA (RE), ITALY | | | |
| DATE OF REGISTRATION | 29/07/2013 | | |
| TITLE | MILKING MACHINE | | |
| PRIORITY | | | |
| PRIORITY NUMBER | DATE | COUNTRY | |
| 002175257-0001 | 30/01/2013 | OHIM | |
| DESIGN NUMBER | | | |
| 253497 | | | |
| CLASS | 14-03 | |  |
| 1)MOPHIE, INC., A CORPORATION ORGANIZED AND EXISTING UNDER THE LAWS OF USA, OF 2850 RED HILL AVENUE, SUITE 128, SANTA ANA, CALIFORNIA-92705, UNITED STATES OF AMERICA | | | |
| DATE OF REGISTRATION | 29/04/2013 | | |
| TITLE | BATTERY CASE FOR A MOBILE DEVICE | | |
| PRIORITY | | | |
| PRIORITY NUMBER | DATE | COUNTRY | |
| 29/435,908 | 30/10/2012 | U.S.A. | |
| DESIGN NUMBER | | | |
| 255911 | | | |
| CLASS | 03-01 | | |
| 1)VALENTINO S.P.A., A CORPORATION ORGANIZED AND EXISTING UNDER THE LAWS OF ITALY, OF VIA TURATI, 16/18, I-20121 MILANO, ITALY | | | |
| DATE OF REGISTRATION | 19/08/2013 | | |
| TITLE | BAG | | |
| PRIORITY | | | |
| PRIORITY NUMBER | DATE | COUNTRY | |
| MI2013O000039 | 05/03/2013 | ITALY | |



| | | |
|--|------------|--|
| DESIGN NUMBER | 257890 |  |
| CLASS | 08-06 | |
| 1)(1) RAMESHBHAI PANCHABHAI PAMBHAR (2) MAGANBHAI PANCHABHAI PAMBHAR (3) TRIBHOVANBHAI PANCHABHAI PAMBHAR (ALL THE PARTNERS ARE ADULT & INDIAN NATIONALS) PARTNERS OF SHREE KHODIYAR INDUSTRIES (INDIAN PARTNERSHIP FIRM) HAVING PLACE OF BUSINESS 2/8, GOKUL NAGAR, 50, FEET ROAD, RAJKOT-360002 GUJARAT-(INDIA) | | |
| DATE OF REGISTRATION | 31/10/2013 | |
| TITLE | HANDLE | |
| PRIORITY NA | | |

| | | |
|--|----------------|---|
| DESIGN NUMBER | 257971 |  |
| CLASS | 07-01 | |
| 1)BONJOUR INTERNATIONAL, A INDIAN PARTNERSHIP FIRM OF 15 UA JAWAHAR NAGAR, DELHI-110007, INDIA, WHOSE PARTNERS ARE (1) RAMAN GUPTA OF 385, DEEPALI, PITAMPURA, DELHI-110034 (2) RAJESH KUMAR GUPTA OF 384, DEEPALI, PITAMPURA, DELHI-110034 AND (3) REENA GUPTA OF 384, DEEPALI, PITAMPURA, DELHI-110034 ALL INDIAN NATIONALS | | |
| DATE OF REGISTRATION | 05/11/2013 | |
| TITLE | TIFFIN CARRIER | |
| PRIORITY NA | | |

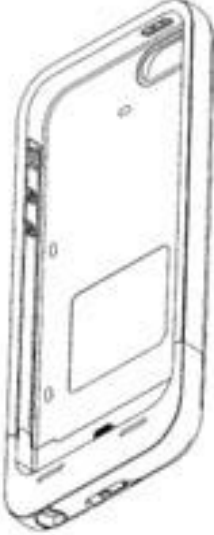
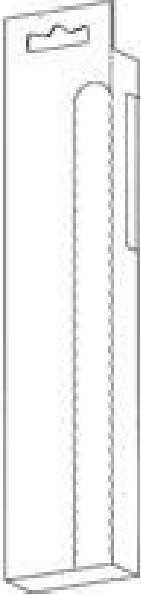
| | | |
|---|------------|--|
| DESIGN NUMBER | 258553 |  |
| CLASS | 25-03 | |
| 1)QUICKEE INFRA PVT LTD, (REGISTERED UNDER THE INDIAN COMPANIES ACT, 1956) REPRESENTED BY ITS CEO, MR. SEAN ETIENNE DE SOUZA, HAVING ITS REGISTERED OFFICE AT NO 9 B, GANGA GRIHA BUILDING, NUNGAMBAKKAM HIGH ROAD, CHENNAI 600 034, TAMIL NADU, INDIA | | |
| DATE OF REGISTRATION | 04/12/2013 | |
| TITLE | STAGE | |
| PRIORITY NA | | |

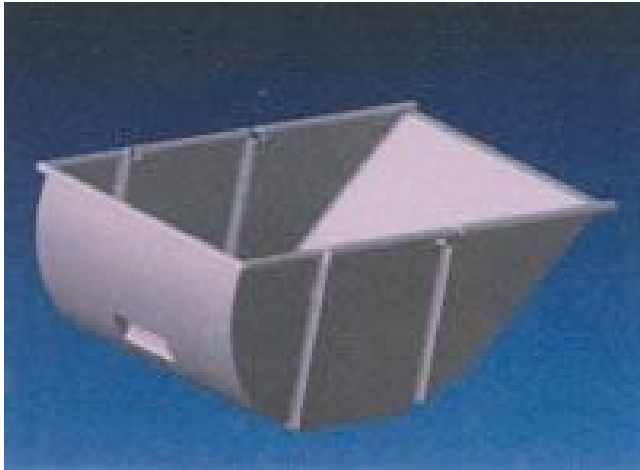
| | | | |
|--|----------------------------------|----------------|--|
| DESIGN NUMBER | 255382 | |  |
| CLASS | 23-04 | | |
| 1)HAVELLS INDIA LIMITED HAVING REGISTERED OFFICE AT 1, RAJ NARAIN MARG, CIVIL LINES, DELHI 110054. | | | |
| DATE OF REGISTRATION | 23/07/2013 | | |
| TITLE | FAN | | |
| PRIORITY NA | | | |
| DESIGN NUMBER | 253496 | |  |
| CLASS | 14-03 | | |
| 1)MOPHIE, INC., A CORPORATION ORGANIZED AND EXISTING UNDER THE LAWS OF USA, OF 2850 RED HILL AVENUE, SUITE 128, SANTA ANA, CALIFORNIA-92705, UNITED STATES OF AMERICA | | | |
| DATE OF REGISTRATION | 29/04/2013 | | |
| TITLE | BATTERY CASE FOR A MOBILE DEVICE | | |
| PRIORITY | | | |
| PRIORITY NUMBER | DATE | COUNTRY | |
| 29/435,907 | 30/10/2012 | U.S.A. | |
| DESIGN NUMBER | | | |
| CLASS | 09-05 | | |
| 1)COLGATE-PALMOLIVE COMPANY, A DELAWARE CORPORATION, 300 PARK AVENUE, NEW YORK, NEW YORK 10022, UNITED STATES OF AMERICA | | | |
| DATE OF REGISTRATION | 19/12/2013 | | |
| TITLE | ORAL CARE IMPLEMENT PACKAGE | | |
| PRIORITY | | | |
| PRIORITY NUMBER | DATE | COUNTRY | |
| 29/461,013 | 17/07/2013 | U.S.A. | |
|  | | | |

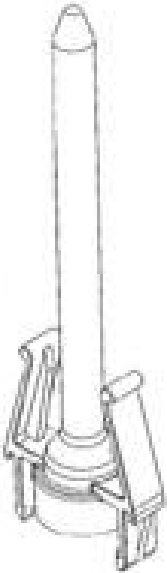
| | | |
|--|---------------------------|--|
| DESIGN NUMBER | 258419 |  |
| CLASS | 27-02 | |
| 1)MR. DARSHAN SHIRASI AN INDIAN NATIONAL OF E-402, PANCHSHEEL GARDEN MAHAVIR NAGAR, KANDIWALI (WEST), MUMBAI-400067, INDIA | | |
| DATE OF REGISTRATION | 27/11/2013 | |
| TITLE | CIGARETTE HOLDER | |
| PRIORITY NA | | |
| DESIGN NUMBER | 257273 |  |
| CLASS | 26-06 | |
| 1)M/S. IJS ELECTRONICS, W-25, OKHLA INDUSTRIAL AREA, PHASE-2, NEW DELHI-110020. (AN INDIA PARTNERSHIP COMPANY) WHOSE PARTNERS ARE MR. JASPAL SINGH AND MRS. SUDARSHAN KAUR. (AN INDIAN NATIONAL) OF THE ABOVE ADDRESS | | |
| DATE OF REGISTRATION | 08/10/2013 | |
| TITLE | LED LIGHT FOR TWO WHEELER | |
| PRIORITY NA | | |
| DESIGN NUMBER | 254712 |  |
| CLASS | 15-04 | |
| 1)MUTUM RANJIT SINGH, AN INDIAN HAVING ITS PRINCIPAL PLACE OF BUSINESS AT YALLU APARTMENT, P-SECTOR, ITANAGAR (ARUNACHAL PRADESH) BY NATIONALITY INDIAN | | |
| DATE OF REGISTRATION | 25/06/2013 | |
| TITLE | BUCKET | |
| PRIORITY NA | | |

| | | | |
|---|--|----------------|---|
| DESIGN NUMBER | 253846 | |  |
| CLASS | 09-07 | | |
| 1)NORDSON CORPORATION, A CORPORATION ORGANIZED UNDER THE LAWS OF THE STATE OF OHIO OF 28601 CLEMENS ROAD, WESTLAKE, OHIO, 44145, USA | | | |
| DATE OF REGISTRATION | 15/05/2013 | | |
| TITLE | NOZZLE FOR SNAP ENGAGEMENT DISPENSING ASSEMBLY | | |
| PRIORITY | | | |
| PRIORITY NUMBER | DATE | COUNTRY | |
| 29/437,504 | 16/11/2012 | U.S.A. | |
| DESIGN NUMBER | 255542 | |  |
| CLASS | 23-01 | | |
| 1)VICTOR EQUIPMENT COMPANY, 2800 AIRPORT ROAD, DENTON, TEXAS 76207, U.S.A. | | | |
| DATE OF REGISTRATION | 29/07/2013 | | |
| TITLE | GAUGE FACE FOR A PRESSURE REGULATOR | | |
| PRIORITY | | | |
| PRIORITY NUMBER | DATE | COUNTRY | |
| 29/444,306 | 29/01/2013 | U.S.A. | |
| DESIGN NUMBER | 258446 | |  |
| CLASS | 12-11 | | |
| 1)MR. PARAMJEET SINGH NARANG INDIAN NATIONAL, CARRYING ON BUSINESS ADDRESS AT 745, BUDHWAR PETH, PHADKE HAUD CHOWK, PUNE-411002, MAHARASHTRA, INDIA | | | |
| DATE OF REGISTRATION | 28/11/2013 | | |
| TITLE | CYCLE | | |
| PRIORITY NA | | | |

| | | |
|--|--------------|--|
| DESIGN NUMBER | 257426 |  |
| CLASS | 07-04 | |
| 1)RAMESHBHAI B. LIMBASIYA AN INDIAN NATIONAL SOLE PROPRIETOR OF BEST HOME APPLIANCES AN INDIAN PROPRIETORSHIP FIRM HAVING ITS PRINCIPAL PLACE OF BUSINESS AT JAY SARDAR INDUSTIRAL AREA, STREET NO. 1, NEAR KOTHARIYA SOLVANT, KOTHARIYA, DIST.: RAJKOT, GUJARAT-INDIA | | |
| DATE OF REGISTRATION | 11/10/2013 | |
| TITLE | ONION CUTTER | |
| PRIORITY NA | | |

| | | |
|--|------------|--|
| DESIGN NUMBER | 257173 |  |
| CLASS | 08-06 | |
| 1)MANISH VALJIBHAI ANDANI (ADULT & INDIAN NATIONAL) PROPRIETOR OF A'LON SALES CORPORATION (INDIAN PROPRIETORSHIP FIRM) HAVING PLACE OF BUSINESS AT: KOTHARIYA MAIN ROAD, 50 FEET ROAD, NEAR SHIV PAN, BEHIND BRAHMANI ELECTRIC, RAJKOT-360002T-GUJARAT-(INDIA) | | |
| DATE OF REGISTRATION | 04/10/2013 | |
| TITLE | HANDLE | |
| PRIORITY NA | | |

| | | |
|---|------------|---|
| DESIGN NUMBER | 245297 |  |
| CLASS | 11-01 | |
| 1)'DE BEERS CENTENARY AG OF ALPENSTRASSE 5, 6000 LUZERN 6, SWITZERLAND, A COMPANY INCORPORATED UNDER SWITZERLAND LAWS | | |
| DATE OF REGISTRATION | 14/05/2012 | |
| TITLE | PENDANT | |
| PRIORITY NA | | |

| | | |
|--|------------|---|
| DESIGN NUMBER | 258165 |  |
| CLASS | 02-05 | |
| 1)TAHLIANI DESIGN PRIVATE LIMITED, WHICH IS OF THE ADDRESS 708, PACE CITY-2, SECTOR-37, PART-II, GURGAON (HARYANA), A COMPANY INCORPORATED UNDER THE LAWS OF INDIA | | |
| DATE OF REGISTRATION | 14/11/2013 | |
| TITLE | PAREO | |
| PRIORITY NA | | |

| | | |
|---|--------------|--|
| DESIGN NUMBER | 256883 |  |
| CLASS | 13-03 | |
| 1)MRS. JAYADEVI JAIN. (AN INDIAN NATIONAL) OF 3, LABH SHREE MARKET, NEAR NEW SIYAGANJ, MALGODAM ROAD, INDORE, STATE OF M.P. (INDIA). PROPRIETOR OF JAG JYOTI INDUSTRIES, AN INDIAN PROPRIETORSHIP FIRM OF ABOVE ADDRESS | | |
| DATE OF REGISTRATION | 30/09/2013 | |
| TITLE | ELECTRIC BOX | |
| PRIORITY NA | | |

| | | |
|---|------------|--|
| DESIGN NUMBER | 258848 |  |
| CLASS | 08-06 | |
| 1)RASIKLAL GHUSABHAI CHOVIYA (ADULT & INDIAN NATIONAL) SOLE PROPRIETOR OF M K TECHNOCAST (INDIAN PROPRIETORSHIP CONCERN) HAVING PLACE OF BUSINESS AT-2, PATEL NAGAR, SADBHAVNA, PLOT, NR: BHAGWATI ENTERPRISE, 50, FEET MAIN ROAD, RAJKOT-GUJARAT-(INDIA) | | |
| DATE OF REGISTRATION | 19/12/2013 | |
| TITLE | HANDLE | |
| PRIORITY NA | | |

| | | |
|---|---------------------|---|
| DESIGN NUMBER | 257203 |  |
| CLASS | 15-02 | |
| 1)MEKO AUTO PVT. LTD., M-24, SECTOR-I, DSIDC, INDUSTRIAL AREA, BAWANA, DELHI-110039, INDIA, AN INDIAN COMPANY REGISTERED UNDER THE PROVISIONS OF INDIAN COMPANIES ACT, 1956, OF THE ABOVE ADDRESS | | |
| DATE OF REGISTRATION | 04/10/2013 | |
| TITLE | WATER PUMP ASSEMBLY | |
| PRIORITY NA | | |
| DESIGN NUMBER | 257868 |  |
| CLASS | 07-02 | |
| 1)TTK PRESTIGE LIMITED, AN INDIAN COMPANY, INCORPORATED UNDER THE COMPANIES ACT 1956, HAVING ITS PRINCIPAL PLACE OF BUSINESS AT 11TH FLOOR, BRIGADE TOWERS, 135 BRIGADE ROAD, BANGALORE-560 025, STATE OF KARNATAKA, INDIA | | |
| DATE OF REGISTRATION | 30/10/2013 | |
| TITLE | INDUCTION STOVE | |
| PRIORITY NA | | |
| DESIGN NUMBER | 253385 |  |
| CLASS | 09-01 | |
| 1)M/S EMAMI LIMITED, A COMPANY INCORPORATED UNDER INDIAN COMPANIES ACT, 1956 HAVING ITS REGISTERED OFFICE ADDRESS AT 687, ANANDAPUR, EM BYPASS, KOLKATA-700107, INDIA BY NATIONALITY INDIAN | | |
| DATE OF REGISTRATION | 23/04/2013 | |
| TITLE | BOTTLE WITH CAP | |
| PRIORITY NA | | |

| | | |
|--|-------------------------|----------------|
| DESIGN NUMBER | 257557 | |
| CLASS | 15-03 | |
| 1)SATAKE CORPORATION 7-2, SOTOKANDA 4-CHOME, CHIYODA-KU, TOKYO, 101-0021, JAPAN, A CORPORATION OF JAPAN | | |
| DATE OF REGISTRATION | 17/10/2013 | |
| TITLE | GRAIN INSPECTION DEVICE | |
| PRIORITY | | |
| PRIORITY NUMBER | DATE | COUNTRY |
| 2013-008778 | 18/04/2013 | JAPAN |

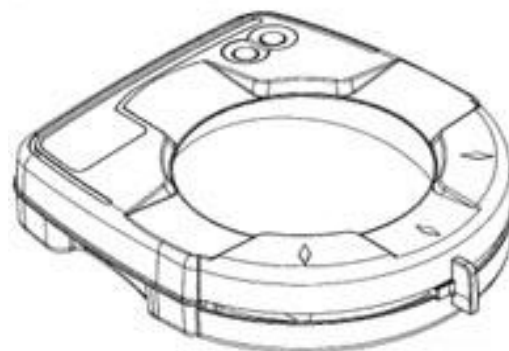

| | | |
|--|--|--|
| DESIGN NUMBER | 258776 | |
| CLASS | 12-11 | |
| 1)MR. ZAHIR SALIM SIYO (AN INDIAN CITIZEN), CHELANKARA HOUSE, VAVAD P.O., 673572-PIN, KOZHIKODE DISTRICT, KERALA STATE, INDIA | | |
| DATE OF REGISTRATION | 17/12/2013 | |
| TITLE | CARRIER CUM HELMET SECURING DEVICE FOR MOTORCYCLE | |
| PRIORITY NA | | |

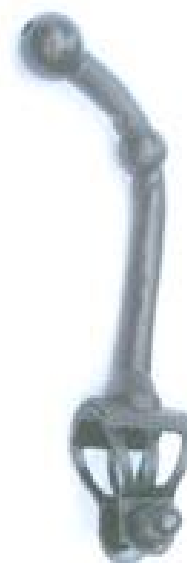

| | | |
|---|------------|--|
| DESIGN NUMBER | 258847 | |
| CLASS | 08-06 | |
| 1)BHIKHABHAI D PATODIYA (INDIAN NATIONALS) SOLE PROPRIETOR OF PATEL INDUSTRIES HAVING PLACE OF BUSINESS AT- MORARINAGAR-4, AVADH KOTHARIYA MAIN ROAD, NR. BABARIYA COLONY, HARIDHARA ROAD, RAJKOT-GUJARAT (INDIA) | | |
| DATE OF REGISTRATION | 19/12/2013 | |
| TITLE | HANDLE | |
| PRIORITY NA | | |



| | | | |
|--|---|----------------|---|
| DESIGN NUMBER | 257202 | |  |
| CLASS | 15-02 | | |
| 1)MEKO AUTO PVT. LTD., M-24, SECTOR-I, DSIDC, INDUSTRIAL AREA, BAWANA, DELHI-110039, INDIA, AN INDIAN COMPANY REGISTERED UNDER THE PROVISIONS OF INDIAN COMPANIES ACT, 1956, OF THE ABOVE ADDRESS | | | |
| DATE OF REGISTRATION | 04/10/2013 | | |
| TITLE | WATER PUMP ASSEMBLY | | |
| PRIORITY NA | | | |
| DESIGN NUMBER | 257796 | |  |
| CLASS | 08-08 | | |
| 1)(1) MEHULBHAI D. CHAVDA (2) SOMESHBHAI S. MALIK AND (3) DHIRENBHAI SHAH ALL INDIAN NATIONAL PARTNER OF DMS ARCHITECTURAL PRODUCTS AN INDIAN PARTNERSHIP FIRM HAVING ITS PRINCIPAL PLACE OF BUSINESS AT ADDRESS: PLOT NO. 6, SURVEY NO. 20, EVEREST INDUSTRIAL AREA, NEAR PERFECT (TATA) SHOWROOM, NATIONAL HIGHWAY NO. 8-B, VAVDI-DIST. RAJKOT-360004, GUJARAT-INDIA | | | |
| DATE OF REGISTRATION | 28/10/2013 | | |
| TITLE | HOOK | | |
| PRIORITY NA | | | |
| DESIGN NUMBER | 255541 | |  |
| CLASS | 23-01 | | |
| 1)VICTOR EQUIPMENT COMPANY, 2800 AIRPORT ROAD, DENTON, TEXAS 76207, U.S.A. | | | |
| DATE OF REGISTRATION | 29/07/2013 | | |
| TITLE | KNOB WITH BONNET FOR A GAS PRESSURE REGULATOR | | |
| PRIORITY | | | |
| PRIORITY NUMBER | DATE | COUNTRY | |
| 29/444,309 | 29/01/2013 | U.S.A. | |

| | | |
|--|-----------------------|--|
| DESIGN NUMBER | 258444 |  |
| CLASS | 12-11 | |
| 1)MR. PARAMJEET SINGH NARANG INDIAN NATIONAL, CARRYING ON BUSINESS ADDRESS AT 745, BUDHWAR PETH, PHADKE HAUD CHOWK, PUNE-411002, MAHARASHTRA, INDIA | | |
| DATE OF REGISTRATION | 28/11/2013 | |
| TITLE | CYCLE | |
| PRIORITY NA | | |
| DESIGN NUMBER | 257664 |  |
| CLASS | 02-04 | |
| 1)JINDAL ALLIANCE POLYMER PRIVATE LIMITED (A COMPANY INCORPORATED UNDER THE INDIAN COMPANIES ACT 1956), J-3082, DSICD INDUSTRIAL AREA, NARELA, DELHI-110040 (INDIA) | | |
| DATE OF REGISTRATION | 22/10/2013 | |
| TITLE | FOOTWEAR | |
| PRIORITY NA | | |
| DESIGN NUMBER | 257374 |  |
| CLASS | 07-02 | |
| 1)L. N. ENGINEERING WORKS PRIVATE LIMITED, A COMPANY REGISTERED IN INDIA, HAVING ITS REGISTERED OFFICE AT 210, KALYANDAS UDYOG BHAVAN, NEXT TO CENTURY BAZAAR, WORLI, MUMBAI-400025, STATE OF MAHARASHTRA, INDIA, OF ABOVE ADDRESS | | |
| DATE OF REGISTRATION | 10/10/2013 | |
| TITLE | SAUCE PAN WITH HANDLE | |
| PRIORITY NA | | |

| | | |
|---|--------------|--|
| DESIGN NUMBER | 257126 |  |
| CLASS | 06-13 | |
| 1) SARITA HANDA DESIGN WORKS PVT. LTD., AN INDIAN COMPANY OF D-11, DEFENCE COLONY, NEW DELHI-110024, INDIA | | |
| DATE OF REGISTRATION | 01/10/2013 | |
| TITLE | PILLOW COVER | |
| PRIORITY NA | | |
| DESIGN NUMBER | 254862 |  |
| CLASS | 26-03 | |
| 1) (1) FALGUN DEVENDRABHAI BHATT (2) SMT. RUJAL FALGUN BHATT BOTH INDIAN NATIONAL AND PARTNERS OF NEETY EURO ASIA SOLAR ENERGY (A PARTNERSHIP FIRM) HAVING THEIR PLACE OF BUSINESS AT BUNGLOW NO. 4, SHREE NAGAR SOCIETY, OPP. GOLDEN TRIANGLE, S.P. STADIUM ROAD, AHMEDABAD-380014 GUJARAT (INDIA) | | |
| DATE OF REGISTRATION | 28/06/2013 | |
| TITLE | SOLAR PANEL | |
| PRIORITY NA | | |
| DESIGN NUMBER | 245293 |  |
| CLASS | 11-01 | |
| 1) "DE BEERS CENTENARY AG OF ALPENSTRASSE 5, 6000 LUZERN 6, SWITZERLAND, A COMPANY INCORPORATED UNDER SWITZERLAND LAWS | | |
| DATE OF REGISTRATION | 14/05/2012 | |
| TITLE | PENDANT | |
| PRIORITY NA | | |

| | | |
|---|----------------|--|
| DESIGN NUMBER | 254012 |  |
| CLASS | 07-04 | |
| 1)RAMESHBHAI B. LIMBASIYA AND VIJAYBHAI S. FACHARA BOTH INDIAN NATIONAL PARTNERS OF SHREEJI PRODUCTS AN INDIAN PARTNERSHIP FIRM HAVING ITS PRINCIPAL PLACE OF BUSINESS AT MAVDI MAIN ROAD, UDAYNAGAR-1, STREET NO. 17, RAJKOT-360004, GUJARAT-INDIA | | |
| DATE OF REGISTRATION | 21/05/2013 | |
| TITLE | FOOD MAKER | |
| PRIORITY NA | | |
| DESIGN NUMBER | 257979 |  |
| CLASS | 10-04 | |
| 1)DAYAL CHAND TRADING AS M/S. SIGMA REFRIGERATION WORKS, 3745, SHOP NO. 1 & 7, KUCHA PARMANAND, NETAJI SUBHASH MARG, DARYA GANJ, NEW DELHI-110002, INDIA (A SOLE PROPRIETORSHIP FIRM) | | |
| DATE OF REGISTRATION | 06/11/2013 | |
| TITLE | PRESSURE GAUGE | |
| PRIORITY NA | | |
| DESIGN NUMBER | 257736 |  |
| CLASS | 12-11 | |
| 1)MITHUN VRAJLAL DARJI, INDIAN NATIONAL, HAVING ADDRESS J-402, DEVNANDAN PLATINA, OPP. SHAYONA TRILAK, NR. VANDEMATARAM CITY, CHANDLODIA, GOTA, AHMEDABAD 382481, GUJARAT STATE, INDIA | | |
| DATE OF REGISTRATION | 25/10/2013 | |
| TITLE | BICYCLE | |
| PRIORITY NA | | |

| | | |
|--|------------|---|
| DESIGN NUMBER | 258221 |  |
| CLASS | 16-05 | |
| 1)SHARMA ELECTRONICS, PROPRIETOR, MR. BHARAT SHREEDUTT SHARMA, INDIAN NATIONAL, HAVING PLACE OF BUSINESS AT A-203, NILKANTH PALACE, NEAR NATRAJ MEDICAL STORES, OPPOSITE SEEMA HALL, 100 FT - ANANDNAGAR ROAD, SHAYAMAL CROSS ROAD, SATELLITE, AHMEDABAD-380015, GUJARAT, INDIA | | |
| DATE OF REGISTRATION | 19/11/2013 | |
| TITLE | TRIPOD | |
| PRIORITY NA | | |

| | | |
|--|------------|---|
| DESIGN NUMBER | 258516 |  |
| CLASS | 07-02 | |
| 1)SAMIR VAKHARIA AN INDIAN PROPRIETOR FIRM AT SAMIR INTERNATIONAL, BS RAJ INDUSTRIAL ESTATE, OPP: NIKHIL HOTEL, NEAR RASHMI BANGLOW, DHUMAL NAGAR, WALIV, VASAI (EAST), DIST.: THANE-401208 MAHARASHTRA (INDIA) | | |
| DATE OF REGISTRATION | 02/12/2013 | |
| TITLE | HOTPOT | |
| PRIORITY NA | | |

| | | |
|---|------------|---|
| DESIGN NUMBER | 257474 |  |
| CLASS | 09-03 | |
| 1)PAWAN ARORA (AN INDIAN NATIONAL) O-4, SECTOR-I, DSIDC, BAWANA INDUSTRIAL AREA, NEW DELHI-110039, [INDIA] | | |
| DATE OF REGISTRATION | 14/10/2013 | |
| TITLE | CONTAINER | |
| PRIORITY NA | | |

| | | |
|---|------------------------------------|---|
| DESIGN NUMBER | 249942 |  |
| CLASS | 09-04 | |
| 1)TOPLAND ENGINES PVT. LTD. (A COMPANY INCORPORATED UNDER THE COMPANIES ACT, 1956) HAVING ITS REGISTERED OFFICE AT 2, UMAKANT PANDIT, UDYOGNAGAR, MAVDI PLOT, RAJKOT-360004 (GUJARAT), INDIA, INDIAN COMPANY | | |
| DATE OF REGISTRATION | 05/12/2012 | |
| TITLE | CRATE | |
| PRIORITY NA | | |
| DESIGN NUMBER | 257272 |  |
| CLASS | 02-03 | |
| 1)M/S. IJS ELECTRONICS, W-25, OKHLA INDUSTRIAL AREA, PHASE-2, NEW DELHI-110020. (AN INDIA PARTNERSHIP COMPANY) WHOSE PARTNERS ARE MR. JASPAL SINGH AND MRS. SUDARSHAN KAUR. (AN INDIAN NATIONAL) OF THE ABOVE ADDRESS | | |
| DATE OF REGISTRATION | 08/10/2013 | |
| TITLE | SHIELD WITH VISOR, FOR MOTOR CYCLE | |
| PRIORITY NA | | |