

## ***CONTINUED FROM PART- 1***

### **INTRODUCTION**

In view of the recent amendment made in the Designs (Amendment) Rules, 2008 with effect from 17/06/2008, Publication of the matter relating to Designs is being published in the Official Journal of The Patent Office. This Journal is being published on weekly basis on every Friday covering the various proceedings on Designs as required according to the provisions of under Rule 22, 25, 27 and 39 of the Design (Amendment) Rules, 2008. All the enquiries on this Official Journal and other information as required by the public should be addressed to the Controller General of Patents, Designs & Trade Marks. Suggestions and comments are requested from all quarters so that the content can be enriched.

## COPYRIGHT PUBLICATION

<b>SL NO</b>	<b>REGISTERED DESIGN NUMBERS</b>	<b>RENEWED ON</b>
1.	190552	15.05.2014
2.	193614	15.05.2014
3.	194305	15.05.2014
4.	194474	30.04.2014
5.	195395	19.05.2014
6.	195598	19.05.2014
7.	195599	19.05.2014
8.	196334	15.05.2014
9.	196335	19.05.2014
10.	196336	19.05.2014
11.	196339	19.05.2014
12.	197617	30.04.2014
13.	197618	30.04.2014
14.	197333	30.04.2014
15.	197334	30.04.2014



**RESTORATION OF LAPSED DESIGNS**  
**UNDER SECTION 12 (2) OF THE DESIGNS ACT, 2000**



An application made under Section 12 (2) of the Designs act, 2000 on **30.01.2014**, for Restoration of Design No.194305 dated **19.01.2004** in the name of **SYMPHONY LIMITED (A COMPANY REGISTERED UNDER THE COMPANIES ACT, 1956)**, **“SAUMYA”**, **BAKERI CIRCLE, NAVRANGPURA, AHMEDABAD-380014, GUJARAT, INDIA** has been allowed.



## REGISTRATION OF DESIGNS

The following designs have been registered. They are now open for public inspection. In the following each entry the Date of Registration is shown. The Priority Number, Priority Date and Priority Country are also shown

<b>DESIGN NUMBER</b>	256762		
<b>CLASS</b>	24-04		
<b>1)KIND CONSUMER LIMITED., OF</b> 79 CLERKENWELL ROAD, LONDON, EC1R 5AR, UNITED KINGDOM; NATIONALITY: UNITED KINGDOM			
<b>DATE OF REGISTRATION</b>	25/09/2013		
<b>TITLE</b>	INHALER		
<b>PRIORITY</b>			
<b>PRIORITY NUMBER</b>	<b>DATE</b>	<b>COUNTRY</b>	
001366249-0001	26/03/2013	OHIM	
<b>DESIGN NUMBER</b>	256170		
<b>CLASS</b>	13-01		
<b>1)SIEMENS AKTIENGESELLSCHAFT, OF</b> WITTELSBACHERPLATZ 2, 80333 MUNCHEN, GERMANY, A GERMAN COMPANY			
<b>DATE OF REGISTRATION</b>	02/09/2013		
<b>TITLE</b>	ELECTROMOTORS		
<b>PRIORITY</b>			
<b>PRIORITY NUMBER</b>	<b>DATE</b>	<b>COUNTRY</b>	
EU 001363949	12/03/2013	OHIM	
<b>DESIGN NUMBER</b>	256391		
<b>CLASS</b>	12-16		
<b>1)HERO MOTOCORP LIMITED, A COMPANY INCORPORATED UNDER THE INDIAN COMPANIES ACT, HAVING ITS OFFICE AT</b> 34, COMMUNITY CENTRE, BASANT LOK, VASANT VIHAR, NEW DELHI-110057			
<b>DATE OF REGISTRATION</b>	12/09/2013		
<b>TITLE</b>	TAIL LIGHT FOR A TWO WHEELED VEHICLE		
<b>PRIORITY NA</b>			

<b>DESIGN NUMBER</b>	257471	
<b>CLASS</b>	09-01	
<b>1)MYSTICAL TECHNOPLAST PVT. LTD. OF PLOT NO- A.2, ROAD NO-2, WAGLE-IND ESTATE, THANE (WEST), MAHARASHTRA, INDIA, INDIAN COMPANY</b>		
<b>DATE OF REGISTRATION</b>	14/10/2013	
<b>TITLE</b>	BOTTLE	
<b>PRIORITY NA</b>		
<b>DESIGN NUMBER</b>	258019	
<b>CLASS</b>	09-01	
<b>1)GODREJ CONSUMER PRODUCTS LIMITED, AN INDIAN COMPANY WHOSE ADDRESS IS PIROJSHANAGAR, EASTERN EXPRESS HIGHWAY, VIKHROLI EAST, MUMBAI- 400079, MAHARASHTRA, AN INDIAN COMPANY</b>		
<b>DATE OF REGISTRATION</b>	07/11/2013	
<b>TITLE</b>	BOTTLE	
<b>PRIORITY NA</b>		
<b>DESIGN NUMBER</b>	255672	
<b>CLASS</b>	31-01	
<b>1)MR. ALPESH KANTILAL PATEL, AN INDIAN NATIONAL, HAVING ITS PRINCIPAL PLACE OF BUSINESS AT, VAASTU, TF-302, 2/3 JYOTI NAGAR CORNER, RAJKOT-360005, GUJARAT, INDIA</b>		
<b>DATE OF REGISTRATION</b>	06/08/2013	
<b>TITLE</b>	BLACK MOUNT FOR WATER PURIFIER	
<b>PRIORITY NA</b>		

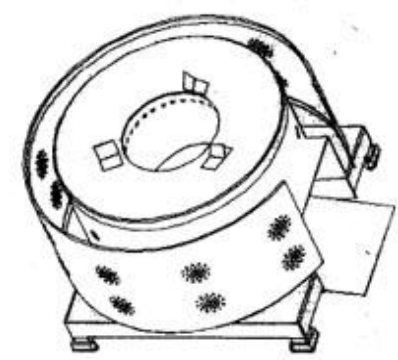
<b>DESIGN NUMBER</b>	256879	
<b>CLASS</b>	11-01	
<b>1)INDERJIT KAUR ARORA, PROPRIETRESS, M/S. NIKKI ARORA FINE JEWELLERY, HAVING HER ADDRESS AT</b> B-507, MANJU MAHAL, PALI HILL, NARGIS DUTT ROAD, BANDRA (WEST), MUMBAI-400 050, MAHARASHTRA, INDIA (INDIAN NATIONAL)		
<b>DATE OF REGISTRATION</b>	27/09/2013	
<b>TITLE</b>	JEWELLERY	
<b>PRIORITY NA</b>		
<b>DESIGN NUMBER</b>	257574	
<b>CLASS</b>	09-03	
<b>1)POWERTECH LUBRICANTS LTD., A REGISTERED INDIAN COMPANY DULY INCORPORATED UNDER THE COMPANIES ACT, 1956 HAVING DIRECTORS 1) GAURAV VERMA 2) RAMESH CHANDER VERMA 3) NIHARIKA VERMA 4) SUSHMA VERMA 5) MIHIR BANERJEE 6) GAGAN BANERJEE AND 7) GAURAV ARORA, ALL OF INDIAN NATIONALITY HAVING REGISTERED ADDRESS AT</b> POWERTECH LUBRICANTS LTD., 817, SECTOR-9, URBAN ESTATE, KARNAL-132001, HARYANA, INDIA		
<b>DATE OF REGISTRATION</b>	21/10/2013	
<b>TITLE</b>	CONTAINER FOR LUBRICANTS	
<b>PRIORITY NA</b>		
<b>DESIGN NUMBER</b>	256387	
<b>CLASS</b>	12-16	
<b>1)HERO MOTOCORP LIMITED, A COMPANY INCORPORATED UNDER THE INDIAN COMPANIES ACT, HAVING ITS OFFICE AT</b> 34, COMMUNITY CENTRE, BASANT LOK, VASANT VIHAR, NEW DELHI-110057		
<b>DATE OF REGISTRATION</b>	12/09/2013	
<b>TITLE</b>	TAIL LIGHT LENS	
<b>PRIORITY NA</b>		

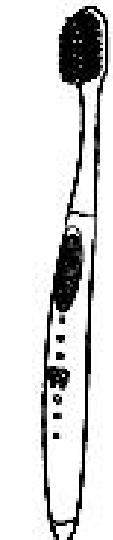
<b>DESIGN NUMBER</b>	255775		
<b>CLASS</b>	07-02		
<b>1)SOUMITRA RAMESH KULKARNI, DIRECTOR, OF SWAMI SAMARTH ELECTRONICS PVT. LTD.,</b> M-63, M.I.D.C., AMBAD, NASHIK-422010			
<b>DATE OF REGISTRATION</b>	12/08/2013		
<b>TITLE</b>	STOVE		
<b>PRIORITY NA</b>			
<b>DESIGN NUMBER</b>	256423		
<b>CLASS</b>	12-16		
<b>1)HERO MOTOCORP LIMITED, A COMPANY INCORPORATED UNDER THE INDIAN COMPANIES ACT, HAVING ITS OFFICE AT</b> 34, COMMUNITY CENTRE, BASANT LOK, VASANT VIHAR, NEW DELHI-110 057			
<b>DATE OF REGISTRATION</b>	13/09/2013		
<b>TITLE</b>	HEAD LIGHT LENS FOR A TWO WHEELED VEHICLE		
<b>PRIORITY NA</b>			
<b>DESIGN NUMBER</b>	256381		
<b>CLASS</b>	04-02		
<b>1)COLGATE-PALMOLIVE COMPANY, A DELAWARE CORPORATION,</b> 300 PARK AVENUE, NEW YORK, NEW YORK 10022, USA			
<b>DATE OF REGISTRATION</b>	11/09/2013		
<b>TITLE</b>	TOOTHBRUSH		
<b>PRIORITY</b>			
<b>PRIORITY NUMBER</b>	<b>DATE</b>	<b>COUNTRY</b>	
29/451,267	29/03/2013	U.S.A.	



<b>DESIGN NUMBER</b>	257180	
<b>CLASS</b>	08-06	
<b>1)HARSHADBHAI KARSANBHAI AJANI (ADULT &amp; INDIAN NATIONAL) SOLE PROPRIETOR OF PAL ENTERPRISE (INDIAN PROPRIETORSHIP CONCERN) HAVING PLACE OF BUSINESS AT: 6, PARSANA SOCIETY, 50 FEET ROAD, KOTHARIA ROAD, RAJKOT-GUJARAT- (INDIA)</b>		
<b>DATE OF REGISTRATION</b>	04/10/2013	
<b>TITLE</b>	HANDLE	
<b>PRIORITY NA</b>		
<b>DESIGN NUMBER</b>	257855	
<b>CLASS</b>	07-01	
<b>1)JOYFUL PLASTICS PRIVATE LIMITED, A COMPANY REGISTERED IN INDIA, HAVING ITS REGISTERED OFFICE AT 15, A/F, NEW EMPIRE INDUSTRIAL ESTATE, KONDIVITA ROAD, J.B.NAGAR, ANDHERI(E), MUMBAI-400 059, STATE OF MAHARASHTRA, INDIA, OF ABOVE ADDRESS</b>		
<b>DATE OF REGISTRATION</b>	29/10/2013	
<b>TITLE</b>	TRAY	
<b>PRIORITY NA</b>		
<b>DESIGN NUMBER</b>	259085	
<b>CLASS</b>	13-01	
<b>1)CROMPTON GREAVES LIMITED, CG HOUSE, 6TH FLOOR, DR. ANNIE BESANT ROAD, WORLI, MUMBAI - 400030, MAHARASHTRA, INDIA; AN INDIAN COMPANY</b>		
<b>DATE OF REGISTRATION</b>	27/12/2013	
<b>TITLE</b>	MOTOR	
<b>PRIORITY NA</b>		



<b>DESIGN NUMBER</b>	256151	
<b>CLASS</b>	15-03	
<b>1)AJINKYA DEELIP INGAWALE AN INDIAN NATIONAL WHOSE ADDRESS IS</b> 36B/2, AGASTI APARTMENT, TARABAI PARK, KOLHAPUR PIN 416 003 MAHARASHTRA, INDIA		
<b>DATE OF REGISTRATION</b>	30/08/2013	
<b>TITLE</b>	SUGARCANE PLANTING DEVICE	
<b>PRIORITY NA</b>		

<b>DESIGN NUMBER</b>	256270	
<b>CLASS</b>	09-01	
<b>1)WEIKFIELD FOODS PVT. LTD., A COMPANY INCORPORATED UNDER THE INDIAN COMPANIES ACT,</b> AT WEIKFIELD ESTATE, GAT NO. 485, LONIKAND, NAGAR ROAD, PUNE-412216, MAHARASHTRA, INDIA		
<b>DATE OF REGISTRATION</b>	06/09/2013	
<b>TITLE</b>	BOTTLE	
<b>PRIORITY NA</b>		

<b>DESIGN NUMBER</b>	256320	
<b>CLASS</b>	14-03	
<b>1)KONINKLIJKE PHILIPS N.V., A COMPANY ORGANIZED AND EXISTING UNDER THE LAWS OF THE KINGDOM OF THE NETHERLANDS, RESIDING AT EINDHOVEN,</b> WHOSE POST-OFFICE ADDRESS IS HIGH TECH CAMPUS 5, 5656 AE EINDHOVEN, THE NETHERLANDS		
<b>DATE OF REGISTRATION</b>	09/09/2013	
<b>TITLE</b>	REMOTE CONTROL UNIT	
<b>PRIORITY</b>		
<b>PRIORITY NUMBER</b>	<b>DATE</b>	<b>COUNTRY</b>
002209510-0001	26/03/2013	OHIM

<b>DESIGN NUMBER</b>	256378		
<b>CLASS</b>	09-01		
<b>1)THE ABSOLUT COMPANY AKTIEBOLAG A COMPANY ORGANIZED AND EXISTING UNDER THE LAWS OF SWEDEN, HAVING ITS OFFICE AT 117 97 STOCKHOLM, SWEDEN</b>			
<b>DATE OF REGISTRATION</b>	11/09/2013		
<b>TITLE</b>	BOTTLE		
<b>PRIORITY</b>			
<b>PRIORITY NUMBER</b>	<b>DATE</b>	<b>COUNTRY</b>	
002201996	13/03/2013	OHIM	
<b>DESIGN NUMBER</b>			
<b>CLASS</b>	10-05		
<b>1)SUBTRONICS (INDIA) PRIVATE LIMITED, A COMPANY REGISTERED IN INDIA, HAVING ITS REGISTERED OFFICE AT 147, KALIANDAS UDYOG BHAVAN, NEAR CENTURY BAZAR, PRABHADEVI, MUMBAI 400025, STATE OF MAHARASHTRA, INDIA, OF ABOVE ADDRESS</b>			
<b>DATE OF REGISTRATION</b>	12/11/2013		
<b>TITLE</b>	BREATH ALCOHOL ANALYSER		
<b>PRIORITY NA</b>			
<b>DESIGN NUMBER</b>			
<b>CLASS</b>	06-08		
<b>1)MAINETTI (UK) LIMITED, A COMPANY INCORPORATED IN SCOTLAND OF ANNFIELD ESTATE, OXNAM ROAD, JEDBURGH, ROXBURGHSHIRE, SCOTLAND, TD8 6NN, UNITED KINGDOM</b>			
<b>DATE OF REGISTRATION</b>	16/08/2013		
<b>TITLE</b>	GARMENT HANGER		
<b>PRIORITY</b>			
<b>PRIORITY NUMBER</b>	<b>DATE</b>	<b>COUNTRY</b>	
4028662	19/02/2013	U.K.	



<b>DESIGN NUMBER</b>	259083	
<b>CLASS</b>	15-02	
<b>1)CROMPTON GREAVES LIMITED,</b> CG HOUSE, 6TH FLOOR, DR. ANNIE BESANT ROAD, WORLI, MUMBAI - 400030, MAHARASHTRA, INDIA; AN INDIAN COMPANY		
<b>DATE OF REGISTRATION</b>	27/12/2013	
<b>TITLE</b>	PUMP	
<b>PRIORITY NA</b>		

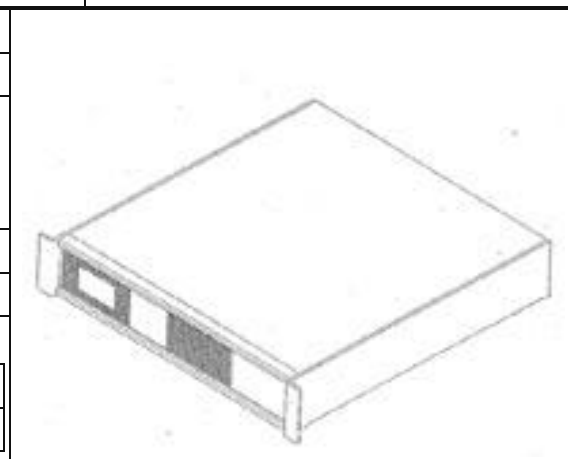

<b>DESIGN NUMBER</b>	257558	
<b>CLASS</b>	14-03	
<b>1)QSC AUDIO PRODUCTS, LLC, A CORPORATION OF CALIFORNIA, OF</b> 1675 MACARTHUR BLVD. COSTA MESA, CALIFORNIA 92626, U.S.A.		
<b>DATE OF REGISTRATION</b>	18/10/2013	
<b>TITLE</b>	AMPLIFIER	
<b>PRIORITY</b>		
<b>PRIORITY NUMBER</b>	<b>DATE</b>	<b>COUNTRY</b>
29/452,632	18/04/2013	U.S.A.



<b>DESIGN NUMBER</b>	255861	
<b>CLASS</b>	15-04	
<b>1)JOSEPH VÖGELE AG,</b> OF JOSEPH-VÖGELE-STRASSE 1, 67067 LUDWIGSHAFEN/RHEIN, GERMANY; NATIONALITY: GERMAN		
<b>DATE OF REGISTRATION</b>	16/08/2013	
<b>TITLE</b>	ROAD PAVING MACHINE	
<b>PRIORITY</b>		
<b>PRIORITY NUMBER</b>	<b>DATE</b>	<b>COUNTRY</b>
001369649	12/04/2013	OHIM





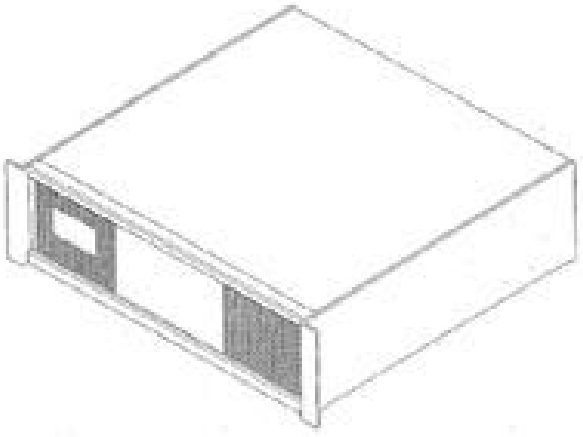

<b>DESIGN NUMBER</b>	256235		
<b>CLASS</b>	26-05		
<b>1)KONINKLIJKE PHILIPS N.V., A COMPANY ORGANIZED AND EXISTING UNDER THE LAWS OF THE KINGDOM OF THE NETHERLANDS, RESIDING AT EINDHOVEN,</b> WHOSE POST-OFFICE ADDRESS IS HIGH TECH CAMPUS 5, 5656 AE EINDHOVEN, THE NETHERLANDS			
<b>DATE OF REGISTRATION</b>	05/09/2013		
<b>TITLE</b>	CEILING LAMP		
<b>PRIORITY</b>			
<b>PRIORITY NUMBER</b>	<b>DATE</b>	<b>COUNTRY</b>	
002200154-0003	11/03/2013	OHIM	
<b>DESIGN NUMBER</b>	257302		
<b>CLASS</b>	06-07		
<b>1)RAVISSANT PRIVATE LIMITED, AN INDIAN COMPANY, OF</b> 50-51, COMMERCIAL COMPLEX, NEW FRIENDS COLONY, NEW DELHI-110065, INDIA			
<b>DATE OF REGISTRATION</b>	08/10/2013		
<b>TITLE</b>	PHOTO FRAME		
<b>PRIORITY NA</b>			
<b>DESIGN NUMBER</b>	258065		
<b>CLASS</b>	09-01		
<b>1)ALLIED BLENDERS AND DISTILLERS PVT. LTD., AN INDIAN COMPANY OF,</b> 394/C, GROUND FLOOR, LAMINGTON CHAMBERS, LAMINGTON ROAD, MUMBAI 400004, MAHARASHTRA, INDIA			
<b>DATE OF REGISTRATION</b>	11/11/2013		
<b>TITLE</b>	BOTTLE		
<b>PRIORITY NA</b>			

<b>DESIGN NUMBER</b>	257577		
<b>CLASS</b>	09-03		
<b>1)POWERTECH LUBRICANTS LTD., A REGISTERED INDIAN COMPANY DULY INCORPORATED UNDER THE COMPANIES ACT, 1956 HAVING DIRECTORS 1) GAURAV VERMA 2) RAMESH CHANDER VERMA 3) NIHARIKA VERMA 4) SUSHMA VERMA 5) MIHIR BANERJEE 6) GAGAN BANERJEE AND 7) GAURAV ARORA, ALL OF INDIAN NATIONALITY HAVING REGISTERED ADDRESS AT</b> POWERTECH LUBRICANTS LTD., 817, SECTOR-9, URBAN ESTATE, KARNAL-132001, HARYANA, INDIA			
<b>DATE OF REGISTRATION</b>	21/10/2013		
<b>TITLE</b>	CONTAINER FOR LUBRICANTS		
<b>PRIORITY NA</b>			
<b>DESIGN NUMBER</b>	256271		
<b>CLASS</b>	23-04		
<b>1)VEGO HOME SCIENCE PRIVATE LIMITED, AN INDIAN COMPANY INCORPORATED UNDER THE COMPANIES ACT OF 1956, HAVING ITS REGISTERED ADDRESS AT</b> GALA NO. 1, JAYATI APARTMENT, NEW LINK ROAD, OPPOSITE SYMPHONY TOWER, KANDIVALI WEST, MUMBAI-400067, INDIA			
<b>DATE OF REGISTRATION</b>	06/09/2013		
<b>TITLE</b>	AIR COOLER		
<b>PRIORITY NA</b>			
<b>DESIGN NUMBER</b>	256326		
<b>CLASS</b>	09-01		
<b>1)UNILEVER PLC, A COMPANY REGISTERED IN ENGLAND AND WALES UNDER COMPANY NO. 41424 OF</b> UNILEVER HOUSE, 100 VICTORIA EMBANKMENT, LONDON, EC4Y 0DY, UNITED KINGDOM			
<b>DATE OF REGISTRATION</b>	09/09/2013		
<b>TITLE</b>	BOTTLE WITH CAP		
<b>PRIORITY</b>			
<b>PRIORITY NUMBER</b>	<b>DATE</b>	<b>COUNTRY</b>	
002199018	08/03/2013	OHIM	

<b>DESIGN NUMBER</b>	255598	
<b>CLASS</b>	13-02	
<b>1)SU-KAM POWER SYSTEMS LTD.</b> OF PLOT NO. WZ-1401/2, NANGAL RAYA, NEW DELHI-110046, INDIA, AN INDIAN COMPANY		
<b>DATE OF REGISTRATION</b>	01/08/2013	
<b>TITLE</b>	COMMERCIAL UPS	
<b>PRIORITY NA</b>		

<b>DESIGN NUMBER</b>	257559	
<b>CLASS</b>	14-03	
<b>1)QSC AUDIO PRODUCTS, LLC, A CORPORATION OF CALIFORNIA, OF</b> 1675 MACARTHUR BLVD. COSTA MESA, CALIFORNIA 92626, U.S.A.		
<b>DATE OF REGISTRATION</b>	18/10/2013	
<b>TITLE</b>	AMPLIFIER	
<b>PRIORITY</b>		
<b>PRIORITY NUMBER</b>	<b>DATE</b>	<b>COUNTRY</b>
29/452,632	18/04/2013	U.S.A.

<b>DESIGN NUMBER</b>	256589	
<b>CLASS</b>	24-01	
<b>1)M/S. PREGNA INTERNATIONAL LIMITED, A COMPANY INCORPORATED UNDER THE COMPANIES ACT 1956 IN INDIA AND HAVING ITS REGISTERED ADDRESS AT</b> 13, SURYODAY ESTATE, 136 TARDEO ROAD, MUMBAI-400034, MAHARASHTRA, INDIA		
<b>DATE OF REGISTRATION</b>	19/09/2013	
<b>TITLE</b>	SOUNDING APPARATUS FOR MEDICAL PURPOSES	
<b>PRIORITY NA</b>		

<b>DESIGN NUMBER</b>	257555		
<b>CLASS</b>	09-01		
<b>1)UNILEVER PLC, A COMPANY REGISTERED IN ENGLAND AND WALES UNDER COMPANY NO. 41424 OF UNILEVER HOUSE, 100 VICTORIA EMBANKMENT, LONDON, EC4Y 0DY, UNITED KINGDOM</b>			
<b>DATE OF REGISTRATION</b>	17/10/2013		
<b>TITLE</b>	BOTTLE		
<b>PRIORITY</b>			
<b>PRIORITY NUMBER</b>	<b>DATE</b>	<b>COUNTRY</b>	
002227850-0001	26/04/2013	OHIM	
<b>DESIGN NUMBER</b>	256532		
<b>CLASS</b>	07-02		
<b>1)DHEERAJ BHANDARI, PROPRIETOR-INDIAN NATIONAL, TRADING AS RAI INDUSTRIES, HAVING ITS OFFICE AT 1102, B-WING, TULSI TOWER, M.G. ROAD, GOREGAON (WEST), MUMBAI-400104, STATE OF MAHARASHTRA, INDIA, OF ABOVE ADDRESS</b>			
<b>DATE OF REGISTRATION</b>	17/09/2013		
<b>TITLE</b>	CASSEROLE		
<b>PRIORITY NA</b>			
<b>DESIGN NUMBER</b>	257427		
<b>CLASS</b>	10-07		
<b>1)ROLEX SA, A JOINT STOCK COMPANY ORGANIZED AND EXISTING UNDER THE LAWS OF SWITZERLAND, OF 3-5-7, RUE FRANÇOIS-DUSSAUD, GENEVA, SWITZERLAND</b>			
<b>DATE OF REGISTRATION</b>	11/10/2013		
<b>TITLE</b>	WATCH DIAL		
<b>PRIORITY</b>			
<b>PRIORITY NUMBER</b>	<b>DATE</b>	<b>COUNTRY</b>	
139 831	12/04/2013	SWITZERLAND	

<b>DESIGN NUMBER</b>	256269	
<b>CLASS</b>	09-01	
<b>1)WEIKFIELD FOODS PVT. LTD., A COMPANY INCORPORATED UNDER THE INDIAN COMPANIES ACT, AT WEIKFIELD ESTATE, GAT NO. 485, LONIKAND, NAGAR ROAD, PUNE-412216, MAHARASHTRA, INDIA</b>		
<b>DATE OF REGISTRATION</b>	06/09/2013	
<b>TITLE</b>	BOTTLE	
<b>PRIORITY NA</b>		
<b>DESIGN NUMBER</b>	258488	
<b>CLASS</b>	08-07	
<b>1)MOHD. SHAHID, TRADING AS M/S. ALIF INDUSTRIES, WHOSE ADDRESS IS GONDA ROAD, ALIGARH-202001, (UTTAR PRADESH) (INDIAN), AN INDIAN NATIONAL OF THE ABOVE ADDRESS</b>		
<b>DATE OF REGISTRATION</b>	29/11/2013	
<b>TITLE</b>	LOCK	
<b>PRIORITY NA</b>		
<b>DESIGN NUMBER</b>	256860	
<b>CLASS</b>	08-08	
<b>1)KULRAJ &amp; CO., OPP. ARYA COLLEGE FOR BOYS, CIVIL LINES, LUDHIANA-141001 (PUNJAB) INDIA. AN INDIAN PARTNERSHIP FIRM WHOSE PARTNERS ARE:- GAURAV GUPTA &amp; SANDEEP GUPTA BEING INDIAN NATIONALS OF THE ABOVE ADDRESS</b>		
<b>DATE OF REGISTRATION</b>	27/09/2013	
<b>TITLE</b>	WINDER FOR MEASURING TAPE	
<b>PRIORITY NA</b>		



<b>DESIGN NUMBER</b>	257511	
<b>CLASS</b>	08-06	
<b>1)MANVIRBHAI B. BALSARA., INDIAN NATIONALITY, SOLE PROPRIETOR OF M/S. SHREE SAI INDUSTRIES, INDIAN NATIONALITY, HAVING ADDRESS AT NR. KHOKHADADI BRIDGE, 6, MADHURAM SOC., NR. N.H. RING ROAD, RAJKOT, GUJARAT STATE, INDIA</b>		
<b>DATE OF REGISTRATION</b>	15/10/2013	
<b>TITLE</b>	HANDLE	
<b>PRIORITY NA</b>		

<b>DESIGN NUMBER</b>	255980	
<b>CLASS</b>	06-03	
<b>1)T. RANJITH KUMAR M/S, G. R. PLASTICS, KRISHANSWAMY TEMPLE ROAD, CHELAMATTOM, PERUMBAVOOR - 683550, ERNAKULAM DISTRICT, KERALA STATE</b>		
<b>DATE OF REGISTRATION</b>	23/08/2013	
<b>TITLE</b>	TEAPOY	
<b>PRIORITY NA</b>		

<b>DESIGN NUMBER</b>	256213		
<b>CLASS</b>	07-02		
<b>1)KONINKLIJKE PHILIPS N.V., A COMPANY ORGANIZED AND EXISTING UNDER THE LAWS OF THE KINGDOM OF THE NETHERLANDS, RESIDING AT EINDHOVEN, WHOSE POST-OFFICE ADDRESS IS HIGH TECH CAMPUS 5, 5656 AE EINDHOVEN, THE NETHERLANDS</b>			
<b>DATE OF REGISTRATION</b>	04/09/2013		
<b>TITLE</b>	AIR FRYER		
<b>PRIORITY</b>			
<b>PRIORITY NUMBER</b>	<b>DATE</b>		<b>COUNTRY</b>
002198499-0001	07/03/2013		OHIM
<b>PRIORITY NA</b>			

<b>DESIGN NUMBER</b>	258505	
<b>CLASS</b>	26-03	
<b>1)NTL ELECTRONICS INDIA LTD., AN INDIAN COMPANY OF THE ADDRESS</b> GURU AMAR DASS, BHAWAN, 78, NEHRU PLACE, NEW DELHI-110019, INDIA		
<b>DATE OF REGISTRATION</b>	29/11/2013	
<b>TITLE</b>	STREET LIGHT	
<b>PRIORITY NA</b>		

<b>DESIGN NUMBER</b>	255495	
<b>CLASS</b>	14-01	
<b>1)SAMSUNG ELECTRONICS CO., LTD., A KOREAN COMPANY, OF 129, SAMSUNG-RO, YEONGTONG-GU, SUWON-SI, GYEONGGI-DO, 443-742M REPUBLIC OF KOREA</b>		
<b>DATE OF REGISTRATION</b>	29/07/2013	
<b>TITLE</b>	SERVER FOR SET TOP BOX	
<b>PRIORITY</b>		
<b>PRIORITY NUMBER</b>	<b>DATE</b>	<b>COUNTRY</b>
30-2013-0005356	30/01/2013	KOREA(SOUTH)

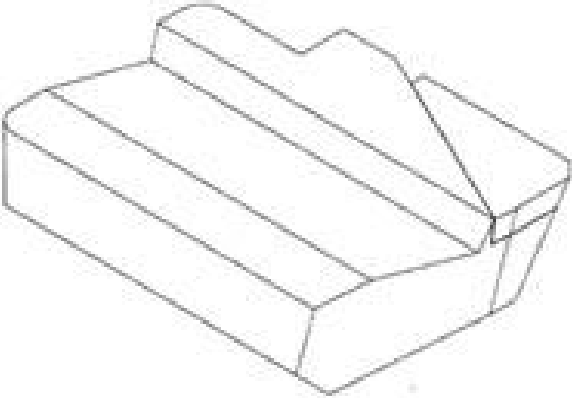
<b>DESIGN NUMBER</b>	255772	
<b>CLASS</b>	08-03	
<b>1)SUMITOMO ELECTRIC HARDMETAL CORP., A CORPORATION ORGANIZED AND EXISTING UNDER THE LAWS OF JAPAN, MANUFACTURERS AND MERCHANTS, OF THE ADDRESS</b> 1-1, KOYAKITA 1-CHOME, ITAMI-SHI, HYOGO, JAPAN		
<b>DATE OF REGISTRATION</b>	12/08/2013	
<b>TITLE</b>	CUTTING INSERT	
<b>PRIORITY</b>		
<b>PRIORITY NUMBER</b>	<b>DATE</b>	<b>COUNTRY</b>
2013-009359	25/04/2013	JAPAN

<b>DESIGN NUMBER</b>	256281		
<b>CLASS</b>	23-04		
1)HUMEX, S.A., A SPANISH COMPANY OF CTRA. LA CANONJA, NAVE 4, 43110 LA CANONJA (TARRAGONA) ESPA A			
<b>DATE OF REGISTRATION</b>	06/09/2013		
<b>TITLE</b>	DEHUMIDIFIER		
<b>PRIORITY</b>			
<b>PRIORITY NUMBER</b>	<b>DATE</b>	<b>COUNTRY</b>	
002244517-0003	27/05/2013	EUROPEAN UNION	
<b>DESIGN NUMBER</b>	256348		
<b>CLASS</b>	09-03		
1)MR. IFTEKHAR AHMED., AN INDIAN CITIZEN, AT 204, S.C.M. ROAD, BHANGAGARA, JORA ASTHATALA, P.O. BHAIKYABATI, DIST. HOOGHLY, PIN-712222, STATE OF WEST BENGAL, INDIA			
<b>DATE OF REGISTRATION</b>	10/09/2013		
<b>TITLE</b>	CONTAINER		
<b>PRIORITY NA</b>			
<b>DESIGN NUMBER</b>	257154		
<b>CLASS</b>	07-02		
1)MR. GHISULAL RATHOD, MR. PRADEEP RATHOD, MR. PANKAJ RATHOD, MR. GAURAV RATHOD, MRS. SANGEETA RATHOD, MRS. BABITA RATHOD AND MRS. PAMPUBEN RATHOD, ALL INDIAN NATIONALS TRADING UNDER THE NAME AND STYLE OF M/S. CELLO INDUSTRIES, A PARTNERSHIP FIRM REGISTERED UNDER THE PROVISION OF INDIAN PARTNERSHIP ACT, 1932, HAVING OFFICE ADDRESS AT CORPORATE AVENUE, 'B' WING, CELLO HOUSE, SONAWALA ROAD, GOREGAON (EAST), MUMBAI0400063, MAHARASHTRA			
<b>DATE OF REGISTRATION</b>	01/10/2013		
<b>TITLE</b>	CASSEROLE		
<b>PRIORITY NA</b>			

<b>DESIGN NUMBER</b>	255668	
<b>CLASS</b>	04-01	
1)KIMBERLY-CLARK WORLDWIDE, INC., A CORPORATION OF THE STATE OF DELAWARE, USA, OF 2300 WINCHESTER ROAD, NEENAH, WISCONSIN 54956, USA		
<b>DATE OF REGISTRATION</b>	06/08/2013	
<b>TITLE</b>	MOP HEAD	
<b>PRIORITY</b>		
<b>PRIORITY NUMBER</b>	<b>DATE</b>	<b>COUNTRY</b>
29/446769	27/02/2013	U.S.A.



<b>DESIGN NUMBER</b>	257522	
<b>CLASS</b>	31-00	
1)INDIAN PRODUCTS LIMITED, A COMPANY REGISTERED UNDER THE COMPANIES ACT 1956 HAVING ITS REGISTERED OFFICE AT NO. 604, QUEENS CORNER 'A', 3 QUEENS ROAD, BANGALORE-560001.		
<b>DATE OF REGISTRATION</b>	15/10/2013	
<b>TITLE</b>	GRINDER JAR	
<b>PRIORITY NA</b>		

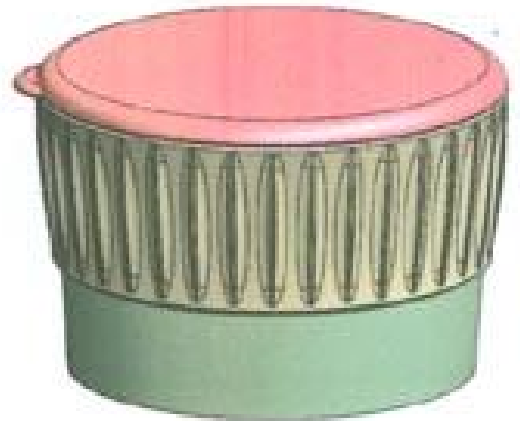

<b>DESIGN NUMBER</b>	257708	
<b>CLASS</b>	24-01	
1)M/S. SEVEN STAR HEALTH CARE PVT. LTD (AN INDIAN COMPANY INCORPORATED UNDER THE COMPANIES ACT, 1956) OF A/1, 201, GOKUL SOCIETY, PLOT NO. 14, SECTOR 9A, NERUL, NAVI MUMBAI-400706, MAHARASHTRA, WITHIN THE UNION BANK OF INDIA.		
<b>DATE OF REGISTRATION</b>	24/10/2013	
<b>TITLE</b>	VACUUM DELIVERY CUP (MEDICAL EQUIPMENT)	
<b>PRIORITY NA</b>		

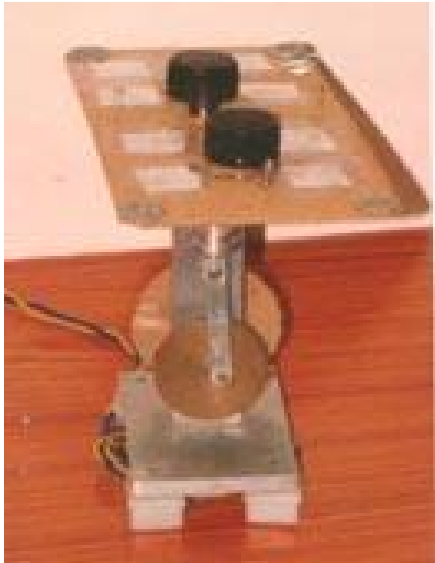

<b>DESIGN NUMBER</b>	256590	
<b>CLASS</b>	13-01	
<b>1)MANNEPALLI VENKATA ADITYA NAG, H. NO. 2-2-647/22, CENTRAL EXCISE COLONY, SIVA NANDA NAGAR, BAGH AMBERPET, HYDERABAD-500013, AN INDIAN NATIONAL</b>		
<b>DATE OF REGISTRATION</b>	19/09/2013	
<b>TITLE</b>	ELECTRICITY GENERATING DEVICE	
<b>PRIORITY NA</b>		

<b>DESIGN NUMBER</b>	256205	
<b>CLASS</b>	15-03	
<b>1)KUBOTA CORPORATION, A JAPANESE CORPORATION OF 2-47, SHIKITSUHIGASHI 1-CHOME, NANIWA-KU, OSAKA- SHI, OSAKA 5568601, JAPAN</b>		
<b>DATE OF REGISTRATION</b>	04/09/2013	
<b>TITLE</b>	ROTARY TILLER	
<b>PRIORITY</b>		
<b>PRIORITY NUMBER</b>	<b>DATE</b>	<b>COUNTRY</b>
2013-012183	31/05/2013	JAPAN

<b>DESIGN NUMBER</b>	258097	
<b>CLASS</b>	30-03	
<b>1)SWASTIK INDUSTRIES, AN INDIAN PROPRIETORSHIP CONCERN, OF WHICH THE PROPRIETOR IS NEERAJ JAIN, AN INDIAN NATIONAL OF C-37/1 WAZIRPUR INDUSTRIAL AREA, DELHI, 110052, INDIA</b>		
<b>DATE OF REGISTRATION</b>	12/11/2013	
<b>TITLE</b>	ANIMAL FOOD BOWL	
<b>PRIORITY NA</b>		

<b>DESIGN NUMBER</b>	257974		
<b>CLASS</b>	07-01		
<b>1)BONJOUR INTERNATIONAL, A INDIAN PARTNERSHIP FIRM OF 15 UA JAWAHAR NAGAR, DELHI-110007, INDIA, WHOSE PARTNERS ARE (1) RAMAN GUPTA OF 385, DEEPALI, PITAMPURA, DELHI-110034 (2) RAJESH KUMAR GUPTA OF 384, DEEPALI, PITAMPURA, DELHI-110034 AND (3) REENA GUPTA OF 384, DEEPALI, PITAMPURA, DELHI-110034 ALL INDIAN NATIONALS</b>			
<b>DATE OF REGISTRATION</b>	05/11/2013		
<b>TITLE</b>	FLASK		
<b>PRIORITY NA</b>			
<b>DESIGN NUMBER</b>	257556		
<b>CLASS</b>	23-04		
<b>1)SPAL AUTOMOTIVE S.R.L., VIA PER CARPI, 26/B, 42015 CORREGGIO (REGGIO EMILIA), ITALY, AN ITALIAN COMPANY.</b>			
<b>DATE OF REGISTRATION</b>	17/10/2013		
<b>TITLE</b>	FAN UNIT		
<b>PRIORITY</b>			
<b>PRIORITY NUMBER</b>	<b>DATE</b>	<b>COUNTRY</b>	
001369144-0001	24/04/2013	OHIM	
<b>DESIGN NUMBER</b>	256559		
<b>CLASS</b>	26-03		
<b>1)NITIN R. SHENOY, INDIAN NATIONAL, 602, JALTARANG, LOKPURAM, DR. GLADYS ALVARES ROAD, OFF. POKHRAN ROAD NO. 2, THANE (W)-400601, MAHARASHTRA, INDIA</b>			
<b>DATE OF REGISTRATION</b>	18/09/2013		
<b>TITLE</b>	LIGHTING FIXTURE		
<b>PRIORITY NA</b>			

<b>DESIGN NUMBER</b>	256173		
<b>CLASS</b>	07-02		
<b>1)HARESHBHAI KODARBHAI PRAJAPATI AN INDIAN NATIONAL SOLE PROPRIETOR OF HARIOM SUPPLIERS AN INDIAN PROPRIETORSHIP FIRM HAVING ITS PRINCIPAL PLACE OF BUSINESS AT</b> VILLAGE: CHOTASAN, POST: CHORIWAD, TA: IDAR, DIST: SABARKANTHA, PIN CODE:383 440, GUJARAT-INDIA			
<b>DATE OF REGISTRATION</b>	02/09/2013		
<b>TITLE</b>	STOVE		
<b>PRIORITY NA</b>			
<b>DESIGN NUMBER</b>	256236		
<b>CLASS</b>	26-05		
<b>1)KONINKLIJKE PHILIPS N.V., A COMPANY ORGANIZED AND EXISTING UNDER THE LAWS OF THE KINGDOM OF THE NETHERLANDS, RESIDING AT EINDHOVEN,</b> WHOSE POST-OFFICE ADDRESS IS HIGH TECH CAMPUS 5, 5656 AE EINDHOVEN, THE NETHERLANDS			
<b>DATE OF REGISTRATION</b>	05/09/2013		
<b>TITLE</b>	CEILING LAMP		
<b>PRIORITY</b>			
<b>PRIORITY NUMBER</b>	<b>DATE</b>	<b>COUNTRY</b>	
002200154-0004	11/03/2013	OHIM	
<b>DESIGN NUMBER</b>	257304		
<b>CLASS</b>	02-04		
<b>1)ALPARGATAS S.A., A CORPORATION ORGANIZED AND EXISTING UNDER THE LAWS OF THE BRAZIL WHO ARE BRAZILIAN BY NATIONALITY AND WHOSE ADDRESS IS</b> AV. DOUTOR CARDOSO DE MELO 1336, VILA OLIMPIA, SÃO PAULO, SP, BRAZI, CEP : 04548-005			
<b>DATE OF REGISTRATION</b>	08/10/2013		
<b>TITLE</b>	FOOTWEAR		
<b>PRIORITY</b>			
<b>PRIORITY NUMBER</b>	<b>DATE</b>	<b>COUNTRY</b>	
002288134-0001	17/08/2013	OHIM	

<b>DESIGN NUMBER</b>	257276	
<b>CLASS</b>	27-02	
<b>1)SYNDICATE HANDICRAFTS., AN INDIAN, A PROPRIETARY CONCERN, HAVING ITS PLACE OF BUSINESS AT H-NO 20-4-839, CHOUK KHILWATH, CHARMINAR, HYDERABAD-500002, ANDHRA PRADESH, INDIA</b>		
<b>DATE OF REGISTRATION</b>	08/10/2013	
<b>TITLE</b>	CIGAR HOLDER	
<b>PRIORITY NA</b>		
<b>DESIGN NUMBER</b>	257797	
<b>CLASS</b>	08-08	
<b>1)(1) MEHULBHAI D. CHAVDA (2) SOMESHBHAI S. MALIK AND (3) DHIRENBHAI SHAH ALL INDIAN NATIONAL PARTNER OF DMS ARCHITECTURAL PRODUCTS AN INDIAN PARTNERSHIP FIRM HAVING ITS PRINCIPAL PLACE OF BUSINESS AT ADDRESS: PLOT NO. 6, SURVEY NO. 20, EVEREST INDUSTRIAL AREA, NEAR PERFECT (TATA) SHOWROOM, NATIONAL HIGHWAY NO. 8-B, VAVDI-DIST. RAJKOT-360 004, GUJARAT-INDIA.</b>		
<b>DATE OF REGISTRATION</b>	28/10/2013	
<b>TITLE</b>	HOOK	
<b>PRIORITY NA</b>		
<b>DESIGN NUMBER</b>	253365	
<b>CLASS</b>	99-00	
<b>1)FLEETGUARD FILTERS PRIVATE LIMITED, A COMPANY INCORPORATED UNDER THE INDIAN COMPANIES ACT, AT 'KIRLOSKAR HOUSE', 100, ANAND PARK, AUNDH, PUNE-411007, MAHARASHTRA, INDIA.</b>		
<b>DATE OF REGISTRATION</b>	23/04/2013	
<b>TITLE</b>	AIR TANK FOR COMPRESSORS	
<b>PRIORITY NA</b>		

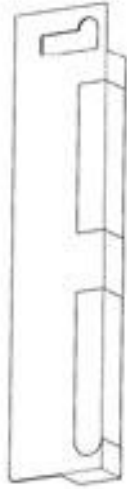
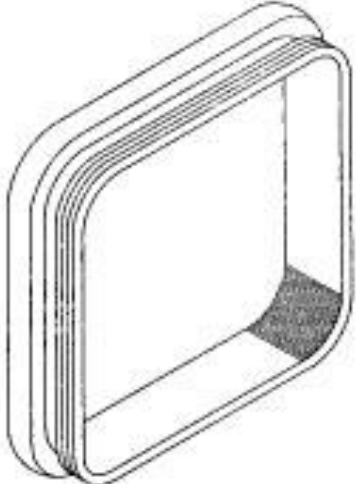
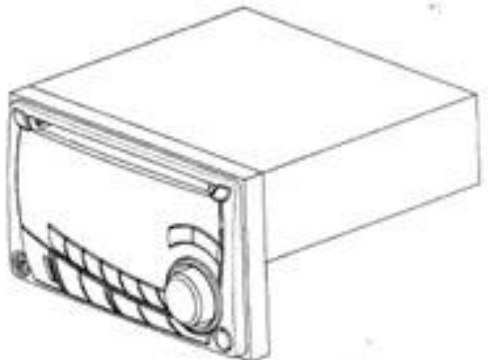

<b>DESIGN NUMBER</b>	258862		
<b>CLASS</b>	09-05		
<b>1)COLGATE-PALMOLIVE COMPANY, A DELAWARE CORPORATION, 300 PARK AVENUE, NEW YORK, NEW YORK 10022, UNITED STATES OF AMERICA</b>			
<b>DATE OF REGISTRATION</b>	19/12/2013		
<b>TITLE</b>	ORAL CARE IMPLEMENT PACKAGE		
<b>PRIORITY</b>			
<b>PRIORITY NUMBER</b>	<b>DATE</b>	<b>COUNTRY</b>	
29/461,014	17/07/2013	U.S.A.	
<b>DESIGN NUMBER</b>			
	256088		
<b>CLASS</b>	07-01		
<b>1)SELVEL INDUSTRIES., INDIAN NATIONAL, 3, 1ST FLOOR, VAKIL INDUSTRIAL ESTATE, WALBHAT ROAD, GOREGAON (EAST), MUMBAI-400063, STATE OF MAHARASHTRA, (INDIA), AN INDIAN NATIONAL, WHOSE PARTNERS ARE 1. PRATEEK CHAMPALAL JAIN 2. VIPUL CHAMPALAL JAIN INDIAN NATIONALS., OF ABOVE ADDRESS</b>			
<b>DATE OF REGISTRATION</b>	28/08/2013		
<b>TITLE</b>	LID		
<b>PRIORITY NA</b>			
<b>DESIGN NUMBER</b>			
	256241		
<b>CLASS</b>	14-01		
<b>1)FUJITSU TEN LIMITED, A COMPANY ORGANIZED AND EXISTING UNDER THE LAWS OF JAPAN, HAVING ITS OFFICE AT 2-28, GOSHO-DORI 1-CHOME, HYOGO-KU, KOBE-SHI, HYOGO, 652-8510 JAPAN</b>			
<b>DATE OF REGISTRATION</b>	05/09/2013		
<b>TITLE</b>	DIGITAL AUDIO DISC PLAYER WITH RADIO TUNER		
<b>PRIORITY NA</b>			

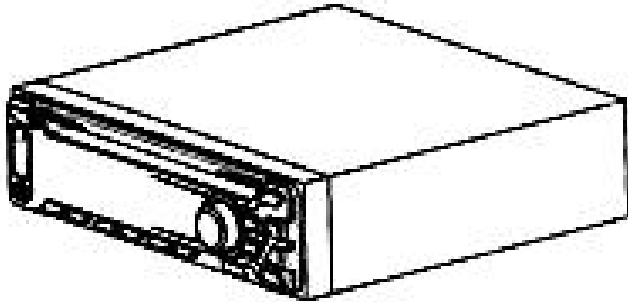

<b>DESIGN NUMBER</b>	257325		
<b>CLASS</b>	28-02		
<b>1)ELC MANAGEMENT LLC, A DELAWARE CORPORATION, HAVING AN OFFICE AT</b> 155 PINELAWN ROAD, SUITE 345 SOUTH, MELVILLE, NY 11747, USA			
<b>DATE OF REGISTRATION</b>	09/10/2013		
<b>TITLE</b>	LIPSTICK BULLET		
<b>PRIORITY</b>			
<b>PRIORITY NUMBER</b>	<b>DATE</b>	<b>COUNTRY</b>	
29/452,656	19/04/2013	U.S.A.	
<b>DESIGN NUMBER</b>	257413		
<b>CLASS</b>	26-06		
<b>1)VOLVO LASTVAGNAR AB, OF</b> SE 405 08 GÖTEBORG, SWEDEN			
<b>DATE OF REGISTRATION</b>	10/10/2013		
<b>TITLE</b>	HEADLAMP FOR VEHICLE		
<b>PRIORITY</b>			
<b>PRIORITY NUMBER</b>	<b>DATE</b>	<b>COUNTRY</b>	
2013/0168	11/04/2013	SWEDEN	
<b>DESIGN NUMBER</b>	258626		
<b>CLASS</b>	12-11		
<b>1)TVS MOTOR COMPANY LIMITED, AN INDIAN COMPANY INCORPORATED UNDER THE COMPANIES ACT, 1956, HAVING ITS REGISTERED OFFICE AT</b> "JAYALAKSHMI ESTATES", 29 (OLD NO. 8) HADDOWS ROAD, CHENNAI 600 006, TAMIL NADU, INDIA			
<b>DATE OF REGISTRATION</b>	09/12/2013		
<b>TITLE</b>	MOTORCYCLE		
<b>PRIORITY NA</b>			

<b>DESIGN NUMBER</b>	256561	
<b>CLASS</b>	26-03	
<b>1)NITIN R. SHENOY, INDIAN NATIONAL, 602, JALTARANG, LOKPURAM, DR. GLADYS ALVARES ROAD, OFF. POKHRAN ROAD NO. 2, THANE (W)-400 601, MAHARASHTRA, INDIA</b>		
<b>DATE OF REGISTRATION</b>	18/09/2013	
<b>TITLE</b>	LIGHTING FIXTURE	
<b>PRIORITY NA</b>		



<b>DESIGN NUMBER</b>	256240	
<b>CLASS</b>	14-01	
<b>1)FUJITSU TEN LIMITED, A COMPANY ORGANIZED AND EXISTING UNDER THE LAWS OF JAPAN, HAVING ITS OFFICE AT 2-28, GOSHO-DORI 1-CHOME, HYOGO-KU, KOBE-SHI, HYOGO, 652-8510 JAPAN</b>		
<b>DATE OF REGISTRATION</b>	05/09/2013	
<b>TITLE</b>	DIGITAL AUDIO DISC PLAYER WITH RADIO TUNER	
<b>PRIORITY NA</b>		



<b>DESIGN NUMBER</b>	256355	
<b>CLASS</b>	23-02	
<b>1)KOHLER CO., A COMPANY ORGANIZED AND EXISTING UNDER THE LAW OF USA, OF 444 HIGHLAND DRIVE, KOHLER, WISCONSIN 53044, UNITED STATES OF AMERICA</b>		
<b>DATE OF REGISTRATION</b>	10/09/2013	
<b>TITLE</b>	TOILET TANK WITH LID	
<b>PRIORITY</b>		
<b>PRIORITY NUMBER</b>	<b>DATE</b>	<b>COUNTRY</b>
29/448,365	12/03/2013	U.S.A.

<b>DESIGN NUMBER</b>	257282	
<b>CLASS</b>	02-05	
<b>1)M/S UNIVERSAL TRADERS, B-X-506/2, TELLIYAN WALI GALI, NEAR IQBAL GANJ CHOWK, LUDHIANA-141 008 (PUNJAB) INDIA</b> AN INDIAN PROPRIETORSHIP FIRM WHOSE PROPRIETOR IS:- NEELAM GUPTA BEING INDIAN NATIONALS OF THE ABOVE ADDRESS		
<b>DATE OF REGISTRATION</b>	08/10/2013	
<b>TITLE</b>	SHAWL	
<b>PRIORITY NA</b>		
<b>DESIGN NUMBER</b>	257893	
<b>CLASS</b>	23-01	
<b>1)DAYAL CHAND TRADING AS M/S. SIGMA REFRIGERATION WORKS,</b> 3745, SHOP NO. 1 & 7, KUCHA PARMANAND, NETAJI SUBHASH MARG, DARYA GANJ, NEW DELHI-110002, INDIA (A SOLE PROPRIETORSHIP FIRM)		
<b>DATE OF REGISTRATION</b>	31/10/2013	
<b>TITLE</b>	BALL VALVE	
<b>PRIORITY NA</b>		
<b>DESIGN NUMBER</b>	256563	
<b>CLASS</b>	26-03	
<b>1)NITIN R. SHENOY, INDIAN NATIONAL,</b> 602, JALTARANG, LOKPURAM, DR. GLADYS ALVARES ROAD, OFF. POKHRAN ROAD NO. 2, THANE (W)-400 601, MAHARASHTRA, INDIA		
<b>DATE OF REGISTRATION</b>	18/09/2013	
<b>TITLE</b>	LIGHTING FIXTURE	
<b>PRIORITY NA</b>		

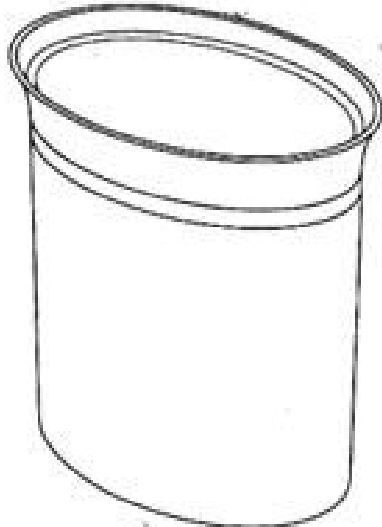
<b>DESIGN NUMBER</b>	257326			
<b>CLASS</b>	28-02			
<b>1)ELC MANAGEMENT LLC, A DELAWARE CORPORATION, HAVING AN OFFICE AT 155 PINELAWN ROAD, SUITE 345 SOUTH, MELVILLE, NY 11747, USA</b>				
<b>DATE OF REGISTRATION</b>	09/10/2013			
<b>TITLE</b>	LIPSTICK BULLET			
<b>PRIORITY</b>				
<b>PRIORITY NUMBER</b>	<b>DATE</b>	<b>COUNTRY</b>		
29/452,657	19/04/2013	U.S.A.		
<b>PRIORITY NA</b>				
<b>PRIORITY NA</b>				
<b>DESIGN NUMBER</b>	257285			
<b>CLASS</b>	02-05			
<b>1)M/S UNIVERSAL TRADERS, B-X-506/2, TELLIYAN WALI GALI, NEAR IQBAL GANJ CHOWK, LUDHIANA-141 008 (PUNJAB) INDIA AN INDIAN PROPRIETORSHIP FIRM WHOSE PROPRIETOR IS:- NEELAM GUPTA BEING INDIAN NATIONALS OF THE ABOVE ADDRESS</b>				
<b>DATE OF REGISTRATION</b>	08/10/2013			
<b>TITLE</b>	SHAWL			
<b>PRIORITY NA</b>				
<b>PRIORITY NA</b>				
<b>DESIGN NUMBER</b>	258156			
<b>CLASS</b>	02-02			
<b>1)TAHILIANI DESIGN PRIVATE LIMITED, WHICH IS OF THE ADDRESS 708, PACE CITY-2, SECTOR-37, PART-II, GURGAON (HARYANA), A COMPANY INCORPORATED UNDER THE LAWS OF INDIA</b>				
<b>DATE OF REGISTRATION</b>	14/11/2013			
<b>TITLE</b>	GARMENT			
<b>PRIORITY NA</b>				
<b>PRIORITY NA</b>				
<b>PRIORITY NA</b>				
<b>PRIORITY NA</b>				
<b>PRIORITY NA</b>				

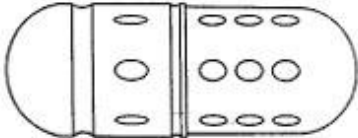
<b>DESIGN NUMBER</b>	255934	
<b>CLASS</b>	11-02	
<b>1)SATISH GOKHALE, INDIAN NATIONAL OF DESIGN DIRECTIONS PVT. LTD., 828, RAJEEV, SHIVAJINAGAR, BHANDARKAR ROAD, LANE #13, PUNE-411004, MAHARASHTRA, INDIA AND YUVRAJ SINGH AHUJA, INDIAN NATIONAL OF FRONTIER POLYMERS PVT. LTD., B-1/H-2, MOHAN CO-OPERATIVE INDUSTRIAL ESTATE, MATHURA ROAD, NEW DELHI-110044, INDIA</b>		
<b>DATE OF REGISTRATION</b>	21/08/2013	
<b>TITLE</b>	PLANTER	
<b>PRIORITY NA</b>		
<b>DESIGN NUMBER</b>	256575	
<b>CLASS</b>	13-03	
<b>1)MITSUBISHI ELECTRIC CORPORATION, A JAPANESE COMPANY ORGANIZED AND EXISTING UNDER THE LAWS OF JAPAN, MANUFACTURERS AND MERCHANTS, OF THE ADDRESS 7-3, MARUNOUCHI 2-CHOME, CHIYODA-KU, TOKYO 100-8310, JAPAN</b>		
<b>DATE OF REGISTRATION</b>	18/09/2013	
<b>TITLE</b>	PROGRAMMABLE CONTROLLER FOR PRODUCTION LINE IN A FACTORY	
<b>PRIORITY NA</b>		
<b>DESIGN NUMBER</b>	257335	
<b>CLASS</b>	08-09	
<b>1)DORMA INDIA PRIVATE LIMITED, COMPANY INCORPORATED UNDER THE COMPANIES ACT, 1956, HAVING ITS REGISTERED OFFICE AT NO. 14, PATTULOS ROAD, CHENNAI-600002, TAMIL NADU, INDIA</b>		
<b>DATE OF REGISTRATION</b>	09/10/2013	
<b>TITLE</b>	STRUCTURAL METAL FITTING	
<b>PRIORITY NA</b>		

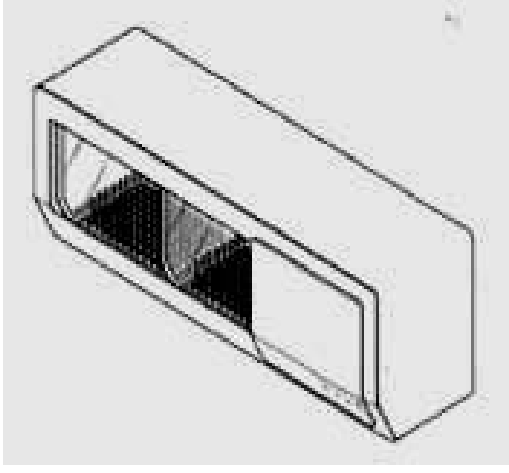
<b>DESIGN NUMBER</b>	257168		
<b>CLASS</b>	09-01		
<b>1)UNILEVER PLC, A COMPANY REGISTERED IN ENGLAND AND WALES UNDER COMPANY NO. 41424 OF UNILEVER HOUSE, 100 VICTORIA EMBANKMENT, LONDON, EC4Y 0DY, UNITED KINGDOM</b>			
<b>DATE OF REGISTRATION</b>	03/10/2013		
<b>TITLE</b>	CONTAINER		
<b>PRIORITY</b>			
<b>PRIORITY NUMBER</b>	<b>DATE</b>	<b>COUNTRY</b>	
002214452-0001	05/04/2013	OHIM	
<b>PRIORITY NA</b>			
<b>DESIGN NUMBER</b>	257289		
<b>CLASS</b>	02-04		
<b>1)THAIKATTIL JOSE, THAIKATTIL HOUSE, OLLUKARA P.O., THRISSUR, KERALA STATE, 680655, INDIA, AN INDIAN NATIONAL</b>			
<b>DATE OF REGISTRATION</b>	08/10/2013		
<b>TITLE</b>	FOOTWEAR		
<b>PRIORITY NA</b>			
<b>DESIGN NUMBER</b>	231521		
<b>CLASS</b>	09-05		
<b>1)KARTIK P.BHATT, "PINAKPANI" BUNGALOW, OPPOSITE SAUMIL APARTMNT, BHIKHABHAI ROAD, V.V. NAGAR 388121, GUJARAT,</b>			
<b>DATE OF REGISTRATION</b>	20/09/2010		
<b>TITLE</b>	CAPSULE FOR PHARMACEUTICALS PRODUCTS		
<b>PRIORITY NA</b>			



<b>DESIGN NUMBER</b>	259074		
<b>CLASS</b>	13-01		
<b>1)CROMPTON GREAVES LIMITED, CG HOUSE, 6TH FLOOR, DR. ANNIE BESANT ROAD, WORLI, MUMBAI - 400030, MAHARASHTRA, INDIA; AN INDIAN COMPANY</b>			
<b>DATE OF REGISTRATION</b>	27/12/2013		
<b>TITLE</b>	MOTOR		
<b>PRIORITY NA</b>			
<b>DESIGN NUMBER</b>	255834		
<b>CLASS</b>	15-05		
<b>1)SAMSUNG ELECTRONICS CO., LTD., A KOREAN COMPANY, OF 129, SAMSUNG-RO, YEONGTONG-GU, SUWON-SI, GYEONGGI-DO, 443-742M REPUBLIC OF KOREA</b>			
<b>DATE OF REGISTRATION</b>	14/08/2013		
<b>TITLE</b>	DISH WASHER		
<b>PRIORITY</b>			
<b>PRIORITY NUMBER</b>	<b>DATE</b>	<b>COUNTRY</b>	
30-2013-0007671	14/02/2013	KOREA(SOUTH)	
<b>DESIGN NUMBER</b>	258633		
<b>CLASS</b>	09-01		
<b>1)MR. SANDEEP SHRIVASTAV, AN INDIAN CITIZEN, PROPRIETOR OF M/S. JDJ BEVERAGES PVT. LTD, AN INDIAN PROPRIETORSHIP COMPANY OF B-2/115, SAFDARJUNG ENCLAVE, NEW DELHI-110029, INDIA</b>			
<b>DATE OF REGISTRATION</b>	09/12/2013		
<b>TITLE</b>	BOTTLE		
<b>PRIORITY NA</b>			



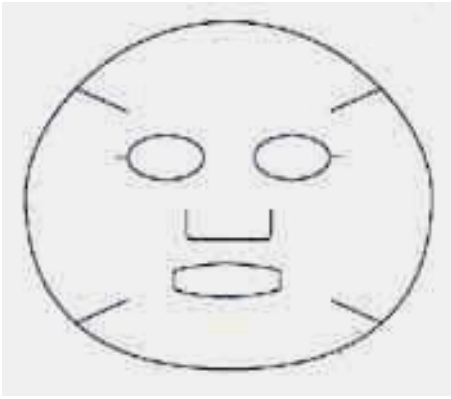

<b>DESIGN NUMBER</b>	256566	
<b>CLASS</b>	08-03	
<b>1)NAVEEN SHARMA,</b> A-4, PRAHLAD MARKET, KAROL BAGH, NEW DELHI-110005 INDIA AN INDIAN NATIONAL OF ABOVE ADDRESS		
<b>DATE OF REGISTRATION</b>	18/09/2013	
<b>TITLE</b>	COVER FOR CIRCULAR SAW	
<b>PRIORITY NA</b>		

<b>DESIGN NUMBER</b>	257334	
<b>CLASS</b>	08-09	
<b>1)DORMA INDIA PRIVATE LIMITED, COMPANY</b> <b>INCORPORATED UNDER THE COMPANIES ACT, 1956, HAVING</b> <b>ITS REGISTERED OFFICE AT</b> NO. 14, PATTULOS ROAD, CHENNAI-600002, TAMIL NADU, INDIA		
<b>DATE OF REGISTRATION</b>	09/10/2013	
<b>TITLE</b>	STRUCTURAL METAL FITTING	
<b>PRIORITY NA</b>		

<b>DESIGN NUMBER</b>	258161	
<b>CLASS</b>	02-02	
<b>1)TAHILIANI DESIGN PRIVATE LIMITED, WHICH IS OF THE ADDRESS</b> 708, PACE CITY-2, SECTOR-37, PART-II, GURGAON (HARYANA), A COMPANY INCORPORATED UNDER THE LAWS OF INDIA		
<b>DATE OF REGISTRATION</b>	14/11/2013	
<b>TITLE</b>	GARMENT	
<b>PRIORITY NA</b>		

<b>DESIGN NUMBER</b>	256109	
<b>CLASS</b>	28-03	
<b>1)SHANGHAI BIOSCIENCE CO., LTD. A LIMITED LIABILITY COMPANY INCORPORATED UNDER THE LAWS OF THE CHINA, WHOSE ADDRESS IS PART 223, 2ND FLOOR, BUILDING 3, NO. 188, AONA ROAD, WAIGAOQIAO FREE TRADE ZONE, SHANGHAI, 200131 CHINA</b>		
<b>DATE OF REGISTRATION</b>	29/08/2013	
<b>TITLE</b>	FACE MASK	
<b>PRIORITY NA</b>		
<b>DESIGN NUMBER</b>	257336	
<b>CLASS</b>	08-09	
<b>1)DORMA INDIA PRIVATE LIMITED, COMPANY INCORPORATED UNDER THE COMPANIES ACT, 1956, HAVING ITS REGISTERED OFFICE AT NO. 14, PATTULOS ROAD, CHENNAI-600002, TAMIL NADU, INDIA</b>		
<b>DATE OF REGISTRATION</b>	09/10/2013	
<b>TITLE</b>	STRUCTURAL METAL FITTING	
<b>PRIORITY NA</b>		
<b>DESIGN NUMBER</b>	258166	
<b>CLASS</b>	02-05	
<b>1)TAHILIANI DESIGN PRIVATE LIMITED, WHICH IS OF THE ADDRESS 708, PACE CITY-2, SECTOR-37, PART-II, GURGAON (HARYANA), A COMPANY INCORPORATED UNDER THE LAWS OF INDIA</b>		
<b>DATE OF REGISTRATION</b>	14/11/2013	
<b>TITLE</b>	PAREO	
<b>PRIORITY NA</b>		

<b>DESIGN NUMBER</b>	255835		
<b>CLASS</b>	15-07		
<b>1)SAMSUNG ELECTRONICS CO., LTD., A KOREAN COMPANY, OF 129, SAMSUNG-RO, YEONGTONG-GU, SUWON-SI, GYEONGGI-DO, 443-742M REPUBLIC OF KOREA</b>			
<b>DATE OF REGISTRATION</b>	14/08/2013		
<b>TITLE</b>	REFRIGERATOR		
<b>PRIORITY</b>			
<b>PRIORITY NUMBER</b>	<b>DATE</b>	<b>COUNTRY</b>	
30-2013-0007682	14/02/2013	KOREA(SOUTH)	
<b>DESIGN NUMBER</b>			
<b>CLASS</b>	254576		
<b>CLASS</b>	24-01		
<b>1)DRÄGER MEDICAL GMBH OF MOISLINGER ALLEE 53-55, D-23558 LÜBECK, GERMANY</b>			
<b>DATE OF REGISTRATION</b>	19/06/2013		
<b>TITLE</b>	MEDICAL SUPPLY UNIT		
<b>PRIORITY</b>			
<b>PRIORITY NUMBER</b>	<b>DATE</b>	<b>COUNTRY</b>	
002157024-0004	20/12/2012	OHIM	
<b>DESIGN NUMBER</b>			
<b>CLASS</b>	258635		
<b>CLASS</b>	31-00		
<b>1)MR. PIYUSH JINDAL, AN INDIAN CITIZEN, PROPRIETOR OF M/S. KPR INTERNATIONAL PVT. LTD., AN INDIAN PROPRIETORSHIP COMPANY OF PLOT NO. 13A/11, SITE-II, LONI ROAD, INDUSTRIAL AREA, MOHAN NAGAR, GHAZIABAD, (UP), INDIA</b>			
<b>DATE OF REGISTRATION</b>	09/12/2013		
<b>TITLE</b>	JUICER MIXER GRINDER		
<b>PRIORITY NA</b>			

<b>DESIGN NUMBER</b>	256553	
<b>CLASS</b>	31-00	
<b>1)THOMAS GEORGE, MAMPUZHACKAL(HOUSE), CHEMPERI (P.O.), KANNUER (DT), KERALA, PIN-670632, NATIONALITY: INDIAN</b>		
<b>DATE OF REGISTRATION</b>	18/09/2013	
<b>TITLE</b>	COCONUT SCRAPER	
<b>PRIORITY NA</b>		
<b>DESIGN NUMBER</b>	258454	
<b>CLASS</b>	09-03	
<b>1)SHRI MAA DISTRIBUTIONS INDIA PVT. LTD., AN INDIAN COMPANY INCORPORATED UNDER THE INDIAN COMPANIES ACT, 1956, HAVING ITS ADDRESS AT 1107, HEMKUNT HOUSE, 6 RAJENDRA PLACE, DELHI-110008, INDIA</b>		
<b>DATE OF REGISTRATION</b>	28/11/2013	
<b>TITLE</b>	TRAY FOR PACKING CHOCOLATE	
<b>PRIORITY NA</b>		
<b>DESIGN NUMBER</b>	258018	
<b>CLASS</b>	09-01	
<b>1)GODREJ CONSUMER PRODUCTS LIMITED, AN INDIAN COMPANY WHOSE ADDRESS IS PIROJSHANAGAR, EASTERN EXPRESS HIGHWAY, VIKHROLI EAST, MUMBAI-400079, MAHARASHTRA, AN INDIAN COMPANY</b>		
<b>DATE OF REGISTRATION</b>	07/11/2013	
<b>TITLE</b>	BOTTLE	
<b>PRIORITY NA</b>		

<b>DESIGN NUMBER</b>	255670	
<b>CLASS</b>	10-07	
<b>1)LA MONTRE HERMES S.A., A SWISS SOCIÉTÉ ANONYME, ERLENSTRASSE 31 A, CH-2555, BRÜGG, SWITZERLAND</b>		
<b>DATE OF REGISTRATION</b>	06/08/2013	
<b>TITLE</b>	WATCH DIAL	
<b>PRIORITY</b>		
<b>PRIORITY NUMBER</b>	<b>DATE</b>	<b>COUNTRY</b>
719159501	07/02/2013	WIPO

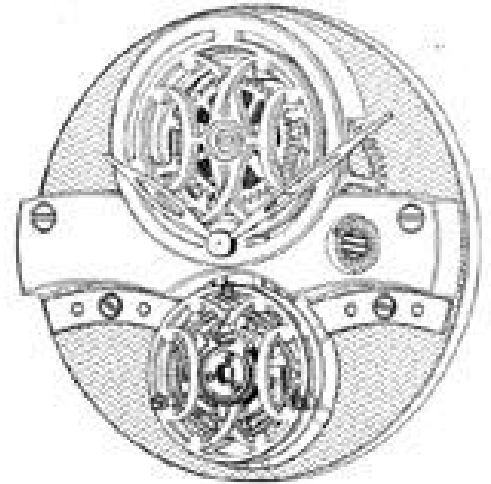



<b>DESIGN NUMBER</b>	256018	
<b>CLASS</b>	23-04	
<b>1)VEGO HOME SCIENCE PRIVATE LIMITED, AN INDIAN COMPANY INCORPORATED UNDER THE COMPANIES ACT OF 1956, HAVING ITS REGISTERED ADDRESS AT GALA NO. 1, JAYATI APARTMENT, NEW LINK ROAD, OPPOSITE SYMPHONY TOWER, KANDIVALI WEST, MUMBAI-400067, INDIA</b>		
<b>DATE OF REGISTRATION</b>	23/08/2013	
<b>TITLE</b>	AIR COOLER	
<b>PRIORITY NA</b>		



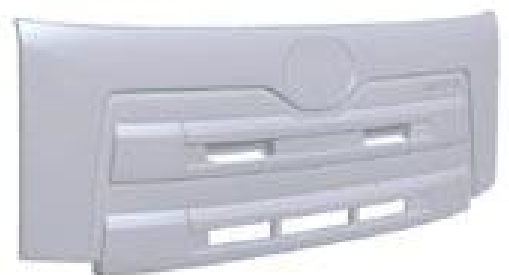

<b>DESIGN NUMBER</b>	257397	
<b>CLASS</b>	12-16	
<b>1)VOLVO LASTVAGNAR AB, OF SE 405 08 GÖTEBORG, SWEDEN</b>		
<b>DATE OF REGISTRATION</b>	10/10/2013	
<b>TITLE</b>	FRONT PANEL FOR VEHICLE	
<b>PRIORITY</b>		
<b>PRIORITY NUMBER</b>	<b>DATE</b>	<b>COUNTRY</b>
2013/0148	11/04/2013	SWEDEN

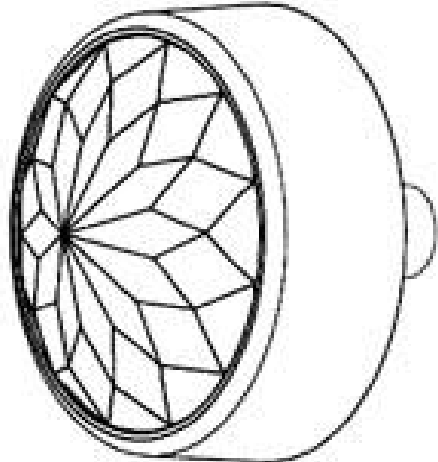

<b>DESIGN NUMBER</b>	256218		
<b>CLASS</b>	23-02		
<b>1) KOHLER CO., A COMPANY ORGANIZED AND EXISTING UNDER THE LAW OF USA,</b> OF 444 HIGHLAND DRIVE, KOHLER, WISCONSIN 53044, UNITED STATES OF AMERICA			
<b>DATE OF REGISTRATION</b>	04/09/2013		
<b>TITLE</b>	WATER CLOSET		
<b>PRIORITY</b>			
<b>PRIORITY NUMBER</b>	<b>DATE</b>	<b>COUNTRY</b>	
29/448,058	08/03/2013	U.S.A.	
<b>DESIGN NUMBER</b>	256332		
<b>CLASS</b>	02-04		
<b>1) DHEERAJ FOOT CRAFT INDIA PVT. LTD (DULY INCORPORATED UNDER THE PROVISION OF THE COMPANY ACT, 1956) AT</b> 103, SECTOR-3, HSIIDC, KARNAL-132001 (HARYANA), WHOSE DIRECTOR IS MANISH BHANDARI, OF THE ABOVE ADDRESS			
<b>DATE OF REGISTRATION</b>	10/09/2013		
<b>TITLE</b>	SOLE OF FOOTWEAR		
<b>PRIORITY NA</b>			
<b>DESIGN NUMBER</b>	254526		
<b>CLASS</b>	07-02		
<b>1) SOCIÉTÉ DES PRODUITS NESTLÉ S.A. A COMPANY INCORPORATED UNDER THE LAWS OF THE SWITZERLAND HAVING ITS REGISTERED OFFICE</b> AT 1800 VEVEY, SWITZERLAND			
<b>DATE OF REGISTRATION</b>	17/06/2013		
<b>TITLE</b>	COFFEE MACHINE		
<b>PRIORITY</b>			
<b>PRIORITY NUMBER</b>	<b>DATE</b>	<b>COUNTRY</b>	
139427	21/12/2012	SWITZERLAND	

<b>DESIGN NUMBER</b>	258654	
<b>CLASS</b>	26-06	
<b>1)MINDA INDUSTRIES LTD. (LIGHTING DIVISION), AN INDIAN COMPANY OF</b> 34-35, K.M. G. T. ROAD, VILL. SONIPAT, HARYANA-131029, INDIA		
<b>DATE OF REGISTRATION</b>	10/12/2013	
<b>TITLE</b>	HOOD LAMP FOR A TRACTOR	
<b>PRIORITY NA</b>		
<b>DESIGN NUMBER</b>	256560	
<b>CLASS</b>	26-03	
<b>1)NITIN R. SHENOY, INDIAN NATIONAL,</b> 602, JALTARANG, LOKPURAM, DR. GLADYS ALVARES ROAD, OFF. POKHRAN ROAD NO. 2, THANE (W)-400 601, MAHARASHTRA, INDIA		
<b>DATE OF REGISTRATION</b>	18/09/2013	
<b>TITLE</b>	LIGHTING FIXTURE	
<b>PRIORITY NA</b>		
<b>DESIGN NUMBER</b>	256174	
<b>CLASS</b>	23-04	
<b>1)HARESHBHAI KODARBHAI PRAJAPATI AN INDIAN NATIONAL SOLE PROPRIETOR OF HARIOM SUPPLIERS AN INDIAN PROPRIETORSHIP FIRM HAVING ITS PRINCIPAL PLACE OF BUSINESS AT</b> VILLAGE: CHOTASAN, POST: CHORIWAD, TA: IDAR, DIST: SABARKANTHA, PIN CODE:383 440, GUJARAT-INDIA		
<b>DATE OF REGISTRATION</b>	02/09/2013	
<b>TITLE</b>	FAN FOR STOVE	
<b>PRIORITY NA</b>		

<b>DESIGN NUMBER</b>	256239	
<b>CLASS</b>	14-01	
<b>1)FUJITSU TEN LIMITED, A COMPANY ORGANIZED AND EXISTING UNDER THE LAWS OF JAPAN, HAVING ITS OFFICE AT</b> 2-28, GOSHO-DORI 1-CHOME, HYOGO-KU, KOBE-SHI, HYOGO, 652-8510 JAPAN		
<b>DATE OF REGISTRATION</b>	05/09/2013	
<b>TITLE</b>	CONTROL KNOB FOR CAR AUDIO EQUIPMENT	
<b>PRIORITY NA</b>		

<b>DESIGN NUMBER</b>	257277	
<b>CLASS</b>	27-02	
<b>1)SYNDICATE HANDICRAFTS., AN INDIAN, A PROPRIETARY CONCERN, HAVING ITS PLACE OF BUSINESS AT</b> H-NO 20-4-839, CHOUK KHILWATH, CHARMINAR, HYDERABAD-500002, ANDHRA PRADESH, INDIA		
<b>DATE OF REGISTRATION</b>	08/10/2013	
<b>TITLE</b>	CIGAR HOLDER	
<b>PRIORITY NA</b>		

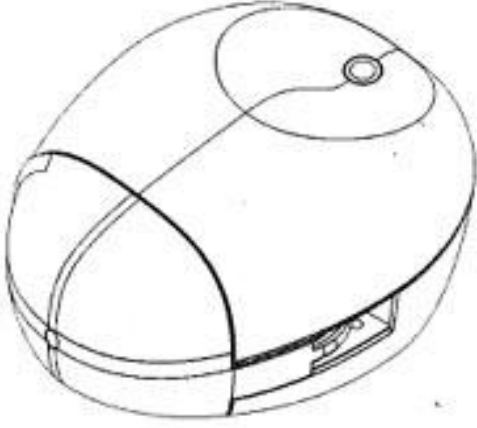
<b>DESIGN NUMBER</b>	258931	
<b>CLASS</b>	24-04	
<b>1)GLENMARK PHARMACEUTICALS LIMITED, AN INDIAN COMPANY REGISTERED UNDER THE COMPANIES ACT, 1956, AND HAVING ITS OFFICE AT</b> GLENMARK HOUSE, HDO - CORPORATE BLDG, WING A, B. D. SAWANT MARG, CHAKALA, ANDHERI (EAST), MUMBAI - 400099, STATE OF MAHARASHTRA, INDIA		
<b>DATE OF REGISTRATION</b>	23/12/2013	
<b>TITLE</b>	INHALER	
<b>PRIORITY NA</b>		



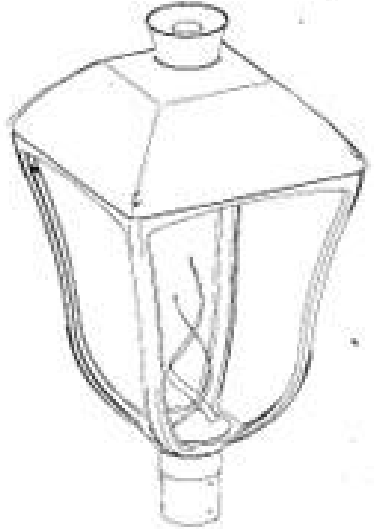

<b>DESIGN NUMBER</b>	255812	
<b>CLASS</b>	07-02	
<b>1)MRS. SIMPLE (PROPRIETOR), NATIONALITY INDIAN TRADING AS TULIP INDUSTRIES (THIS IS A PROPRIETORSHIP FIRM) WHOES ADDRESS IS</b> C-130, SECTOR-3, BAWANA INDUSTRIAL AREA, DELHI-110039 (INDIA)		
<b>DATE OF REGISTRATION</b>	14/08/2013	
<b>TITLE</b>	PLATE	
<b>PRIORITY NA</b>		

<b>DESIGN NUMBER</b>	256096	
<b>CLASS</b>	06-09	
<b>1)CRAYTOP SOLUTIONS PVT. LTD. OF REGD. OFFICE:- B-80, SHASTRI NAGAR, JODHPUR-342003 (RAJASTHAN) &amp; CORPORATE OFFICE:- E-4, SUVIDHA COMPLEX, SHASTRI NAGAR, JODHPUR-342003 (RAJASTHAN), INDIA,</b> AN INDIAN PRIVATE LIMITED COMPANY WHOSE DIRECTOR IS KAPIL SANCHETI, INDIAN NATIONAL OF ABOVE ADDRESS		
<b>DATE OF REGISTRATION</b>	28/08/2013	
<b>TITLE</b>	BACKREST	
<b>PRIORITY NA</b>		

<b>DESIGN NUMBER</b>	256587	
<b>CLASS</b>	26-03	
<b>1)SCHREDER S.A. OF</b> RUE DE LUSAMBO, 67, B. 1190 BRUXELLES, BELGIUM, A BELGIUM COMPANY		
<b>DATE OF REGISTRATION</b>	18/09/2013	
<b>TITLE</b>	OUTDOOR LIGHTING FIXTURE	
<b>PRIORITY</b>		
<b>PRIORITY NUMBER</b>	<b>DATE</b>	<b>COUNTRY</b>
001370456-0001	03/05/2013	OHIM

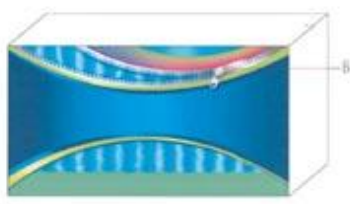
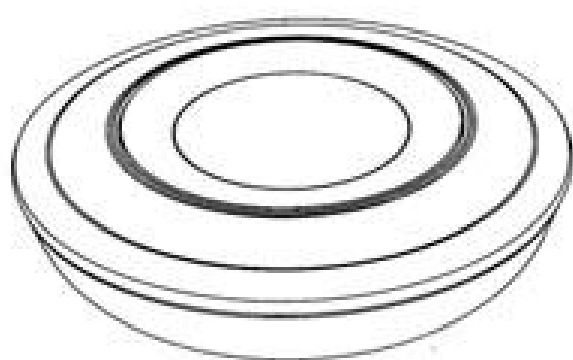
<b>DESIGN NUMBER</b>	256626		
<b>CLASS</b>	23-01		
<b>1)UNILEVER PLC, A COMPANY REGISTERED IN ENGLAND AND WALES UNDER COMPANY NO. 41424 OF UNILEVER HOUSE, 100 VICTORIA EMBANKMENT, LONDON, EC4Y 0DY, UNITED KINGDOM</b>			
<b>DATE OF REGISTRATION</b>	19/09/2013		
<b>TITLE</b>	WATER PURIFICATION DEVICE		
<b>PRIORITY</b>			
<b>PRIORITY NUMBER</b>	<b>DATE</b>	<b>COUNTRY</b>	
002205559	20/03/2013	OHIM	
<b>PRIORITY NA</b>			
<b>DESIGN NUMBER</b>	256137		
<b>CLASS</b>	12-16		
<b>1)DEERE &amp; COMPANY, A US CORPORATION OF ONE JOHN DEERE PLACE, MOLINE, ILLINOIS, 61265 - 8098, USA</b>			
<b>DATE OF REGISTRATION</b>	30/08/2013		
<b>TITLE</b>	TELESCOPIC ROLL OVER PROTECTIVE STRUCTURE		
<b>PRIORITY NA</b>			
<b>DESIGN NUMBER</b>	256746		
<b>CLASS</b>	12-16		
<b>1)MR. SURESH RAMPRAKASH CHAWLA., HAVING ADDRESS AT KARISHMA NEST, ROW HOUSE NO:-8, MORWADI, PIMPRI, PUNE:-411018, MAHARASHTRA STATE, INDIA NATIONALITY:- INDIAN</b>			
<b>DATE OF REGISTRATION</b>	25/09/2013		
<b>TITLE</b>	MULTIPLE ARTICLE LOCKING DEVICE FOR VEHICLES		
<b>PRIORITY NA</b>			

<b>DESIGN NUMBER</b>	233398		
<b>CLASS</b>	09-03		
<b>1)THE PROCTER &amp; GAMBLE COMPANY.,</b> ONE PROCTER & GAMBLE PLAZA, CINCINNATI, OHIO-45202, UNITED STATES OF AMERICA			
<b>DATE OF REGISTRATION</b>	20/12/2010		
<b>TITLE</b>	FEMININE HYGIENE PRODUCT PACKAGE		
<b>PRIORITY</b>			
PRIORITY NUMBER	DATE	COUNTRY	
WO 552813001	18/06/2010	WIPO	
<b>DESIGN NUMBER</b>	255836		
<b>CLASS</b>	14-03		
<b>1)BOSE CORPORATION, A CORPORATION OF THE STATE OF DELAWARE,</b> OF THE MOUNTAIN, MS40 FRAMINGHAM, MASSACHUSETTS 01701-9168, UNITED STATES OF AMERICA			
<b>DATE OF REGISTRATION</b>	14/08/2013		
<b>TITLE</b>	REMOTE CONTROL		
<b>PRIORITY</b>			
PRIORITY NUMBER	DATE	COUNTRY	
29449081	14/03/2013	U.S.A.	
<b>DESIGN NUMBER</b>	256132		
<b>CLASS</b>	19-06		
<b>1)KLIO-ETERNA SCHREIBGERÄTE GMBH &amp; CO KG,</b> OF GLASHÜTTENWEG 7, 77709 WOLFACH, GERMANY			
<b>DATE OF REGISTRATION</b>	30/08/2013		
<b>TITLE</b>	WRITING INSTRUMENT		
<b>PRIORITY</b>			
PRIORITY NUMBER	DATE	COUNTRY	
723994301	05/03/2013	WIPO	

<b>DESIGN NUMBER</b>	256564	
<b>CLASS</b>	26-03	
<b>1)NITIN R. SHENOY, INDIAN NATIONAL, 602, JALTARANG, LOKPURAM, DR. GLADYS ALVARES ROAD, OFF. POKHRAN ROAD NO. 2, THANE (W)-400 601, MAHARASHTRA, INDIA</b>		
<b>DATE OF REGISTRATION</b>	18/09/2013	
<b>TITLE</b>	LIGHTING FIXTURE	
<b>PRIORITY NA</b>		

<b>DESIGN NUMBER</b>	256358	
<b>CLASS</b>	12-16	
<b>1)RAVIBHAI M. VYAS AN INDIAN NATIONAL SOLE PROPRIETOR OF AMBIKA INDUSTRIES AN INDIAN PROPRIETORSHIP FIRM HAVING ITS PRINCIPAL PLACE OF BUSINESS AT SHED NO. 259/2, VARDHMAN INDUSTRIAL AREA, OPP. KOTHARIYA SOLVANT RAILWAY CROSSING, RAJKOT-362121, GUJARAT-INDIA</b>		
<b>DATE OF REGISTRATION</b>	10/09/2013	
<b>TITLE</b>	BRAKE PADDLE FOR VEHICLES	
<b>PRIORITY NA</b>		

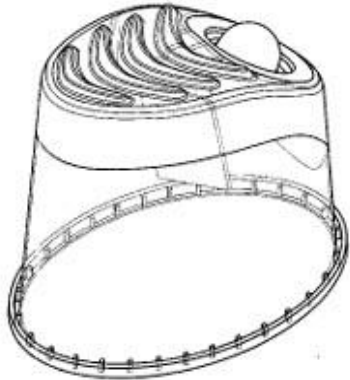
<b>DESIGN NUMBER</b>	255935	
<b>CLASS</b>	09-07	
<b>1)RECKITT BENCKISER (BRANDS) LIMITED, 103-105 BATH ROAD, SLOUGH BERKSHIRE, SL1 3UH, UNITED KINGDOM</b>		
<b>DATE OF REGISTRATION</b>	21/08/2013	
<b>TITLE</b>	CAP FOR A BOTTLE	
<b>PRIORITY</b>		
<b>PRIORITY NUMBER</b>	<b>DATE</b>	<b>COUNTRY</b>
002191742-0001	26/02/2013	OHIM

<b>DESIGN NUMBER</b>	256388	
<b>CLASS</b>	12-16	
<b>1)HERO MOTOCORP LIMITED, A COMPANY INCORPORATED UNDER THE INDIAN COMPANIES ACT, HAVING ITS OFFICE AT 34, COMMUNITY CENTRE, BASANT LOK, VASANT VIHAR, NEW DELHI-110057</b>		
<b>DATE OF REGISTRATION</b>	12/09/2013	
<b>TITLE</b>	CHAIN CASE HUGGER	
<b>PRIORITY NA</b>		

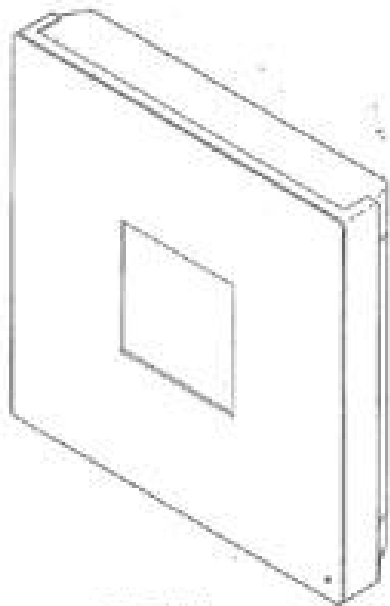
<b>DESIGN NUMBER</b>	257782		
<b>CLASS</b>	23-04		
<b>1)LG ELECTRONICS INC., 20 YEOUIDO-DONG YEONGDEUNGPO - GU SEOUL, 150-721 REPUBLIC OF KOREA, A CORPORATION INCORPORATED UNDER THE LAWS OF THE REPUBLIC OF KOREA</b>			
<b>DATE OF REGISTRATION</b>	25/10/2013		
<b>TITLE</b>	AIR CONDITIONER		
<b>PRIORITY</b>			
<b>PRIORITY NUMBER</b>	<b>DATE</b>	<b>COUNTRY</b>	
30-2013-0027026	24/05/2013	REPUBLIC OF KOREA	

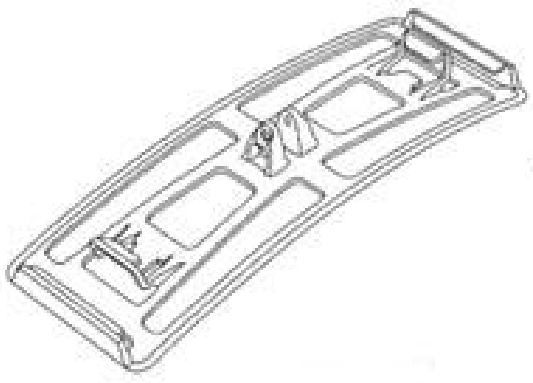
<b>DESIGN NUMBER</b>	255667		
<b>CLASS</b>	04-01		
<b>1)KIMBERLY-CLARK WORLDWIDE, INC., A CORPORATION OF THE STATE OF DELAWARE, USA, OF 2300 WINCHESTER ROAD, NEENAH, WISCONSIN 54956, USA</b>			
<b>DATE OF REGISTRATION</b>	06/08/2013		
<b>TITLE</b>	MOP HEAD		
<b>PRIORITY</b>			
<b>PRIORITY NUMBER</b>	<b>DATE</b>	<b>COUNTRY</b>	
29/446764	27/02/2013	U.S.A.	

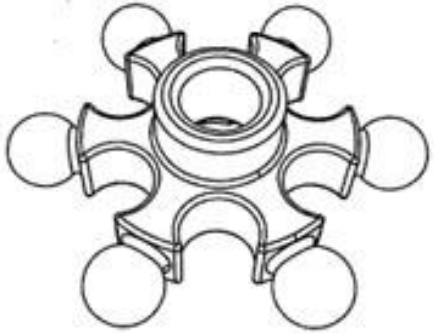
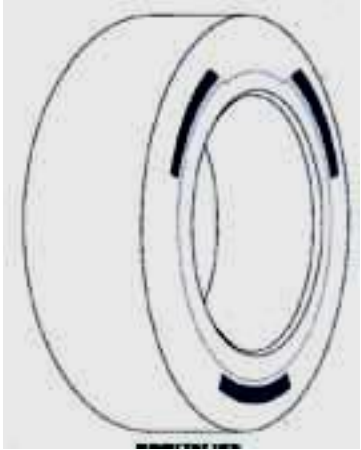
<b>DESIGN NUMBER</b>	257568		
<b>CLASS</b>	21-01		
<b>1)MAGIC PRODUCTION GROUP S.A., AT</b> FINDEL BUSINESS CENTER, COMPLEXE B, RUE DE TRÈVES, L-2632 FINDEL, LUXEMBOURG			
<b>DATE OF REGISTRATION</b>	18/10/2013		
<b>TITLE</b>	TOY CONSTRUCTION ELEMENT		
<b>PRIORITY</b>			
PRIORITY NUMBER	DATE	COUNTRY	
002226233-0002	24/04/2013	OHIM	
<b>DESIGN NUMBER</b>	255994		
<b>CLASS</b>	12-15		
<b>1)CONTINENTAL REIFEN DEUTSCHLAND GMBH</b> VAHRENWALDER STR. 9, 30165 HANNOVER, GERMANY			
<b>DATE OF REGISTRATION</b>	23/08/2013		
<b>TITLE</b>	TYRE TREAD		
<b>PRIORITY</b>			
PRIORITY NUMBER	DATE	COUNTRY	
002212274 - 0001	02/04/2013	OHIM	