

***CONTINUED FROM PART- 1***

**INTRODUCTION**

In view of the recent amendment made in the Designs (Amendment) Rules, 2008 with effect from 17/06/2008, Publication of the matter relating to Designs is being published in the Official Journal of The Patent Office. This Journal is being published on weekly basis on every Friday covering the various proceedings on Designs as required according to the provisions of under Rule 22, 25, 27 and 39 of the Design (Amendment) Rules, 2008. All the enquiries on this Official Journal and other information as required by the public should be addressed to the Controller General of Patents, Designs & Trade Marks. Suggestions and comments are requested from all quarters so that the content can be enriched.

## **COPYRIGHT PUBLICATION**

<b>SL NO</b>	<b>CASE NUMBERS</b>	<b>RENEWED ON</b>
1.	194313	28.03.2014
2.	195498	28.03.2014
3.	195813	10.04.2014
4.	195814	10.04.2014
5.	196248	27.03.2014
6.	196249	27.03.2014
7.	196470	28.03.2014
8.	196541	28.03.2014
9.	196756	10.04.2014
10.	196757	10.04.2014
11.	196811	10.04.2014
12.	196814	10.04.2014
13.	196939	10.04.2014
14.	197619	10.04.2014
15.	237661	27.03.2014

**CANCELLATION PROCEEDINGS**  
**under Section 19 of the Designs Act, 2000**

“The Asstt. Controller of Patents & Designs passed an order on 28/4/2014 to dismiss the petition filed by Suresh Kumar Banka, Rejesh Kumar Banka and Dinesh Kumar Banka of 3B, Camac Street, Kolkata – 700016, West Bengal, India and Mrs. Madhu Karoria of 32Q, New Road, Kolkata – 700027, West Bengal, India, legal heirs of Late Tara Chand Banka on 12/2/2007 for cancellation of registration of registered Design No. 193033 dated 28/8/2003 under class 08-07 titled as ‘Plastic Seal’ in the name of Artiben Subhashbhai Panchal, having nationality Indian, sole proprietor of Atlas Plastic, 22, Madhura Complex, near Keshavnagar, Subhashbridge, Ahmedabad-380027, Gujarat, India, an Indian sole proprietary concern .”



**THE DESIGNS ACT 2000**  
**SECTION 30**  
**DESIGN ASSIGNMENT**

The Design stands in the name of EP SYSTEMS SA registered under the Designs Act, 2000 has been assigned in the Register of Designs in the name as follows:-

<b>Design No.</b>	<b>Class</b>	<b>Name</b>
<b>232551</b>	<b>09-07</b>	APTAR RADOLFZELL GMBH OF, OESCHLESTRASSE 54-56 IN 78315 RADOLFZELL, GERMANY, A LIMITED LIABILITY COMPANY OF GERMANY

## REGISTRATION OF DESIGNS

The following designs have been registered. They are now open for public inspection. In the following each entry the Date of Registration is shown. The Priority Number, Priority Date and Priority Country are also shown

<b>DESIGN NUMBER</b>	255126			
<b>CLASS</b>	12-08			
1) <b>VOLVO TRUCK CORPORATION,</b> OF 40508 GOTEBOG, SWEDEN				
<b>DATE OF REGISTRATION</b>	11/07/2013			
<b>TITLE</b>	VEHICLE CAB			
<b>PRIORITY</b>				
PRIORITY NUMBER	DATE	COUNTRY		
002179085-0001	06/02/2013	OHIM		
<b>DESIGN NUMBER</b>	255027			
<b>CLASS</b>	24-01			
1) <b>KONINKLIJKE PHILIPS N.V., A COMPANY ORGANIZED AND EXISTING UNDER THE LAWS OF THE KINGDOM OF THE NETHERLANDS, RESIDING AT EINDHOVEN,</b> WHOSE POST-OFFICE ADDRESS IS HIGH TECH CAMPUS 5, 5656 AE EINDHOVEN, THE NETHERLANDS				
<b>DATE OF REGISTRATION</b>	05/07/2013			
<b>TITLE</b>	LIGHT THERAPY DEVICE			
<b>PRIORITY</b>				
PRIORITY NUMBER	DATE	COUNTRY		
002163618-0001	09/01/2013	OHIM		
<b>DESIGN NUMBER</b>	255212			
<b>CLASS</b>	26-05			
1) <b>SCHREDER S.A.</b> OF RUE DE LUSAMBO, 67, B. 1190 BRUXELLES, BELGIUM, A BELGIUM COMPANY				
<b>DATE OF REGISTRATION</b>	12/07/2013			
<b>TITLE</b>	OUTDOOR LIGHTING FIXTURE			
<b>PRIORITY</b>				
PRIORITY NUMBER	DATE	COUNTRY		
1363881-0003	11/03/2013	OHIM		

<b>DESIGN NUMBER</b>	254394	
<b>CLASS</b>	24-01	
<b>1)KONINKLIJKE PHILIPS N.V., A COMPANY ORGANIZED AND EXISTING UNDER THE LAWS OF THE KINGDOM OF THE NETHERLANDS, RESIDING AT EINDHOVEN, WHOSE POST-OFFICE ADDRESS IS HIGH TECH CAMPUS 5, 5656 AE EINDHOVEN, THE NETHERLANDS</b>		
<b>DATE OF REGISTRATION</b>	07/06/2013	
<b>TITLE</b>	INFANT WARMER	
<b>PRIORITY</b>		
<b>PRIORITY NUMBER</b>	<b>DATE</b>	<b>COUNTRY</b>
002150243-0002	10/12/2012	OHIM







<b>DESIGN NUMBER</b>	253425	
<b>CLASS</b>	09-01	
<b>1)GODREJ CONSUMER PRODUCTS LIMITED, AN INDIAN COMPANY HAVING ITS REGISTERED OFFICE AT PIROJSHANAGAR, EASTERN EXPRESS HIGHWAY, VIKHROLI, MUMBAI-400079, STATE OF MAHARASHTRA, INDIA</b>		
<b>DATE OF REGISTRATION</b>	25/04/2013	
<b>TITLE</b>	BOTTLE WITH WICK FOR MOSQUITO REPELLENT MACHINE	



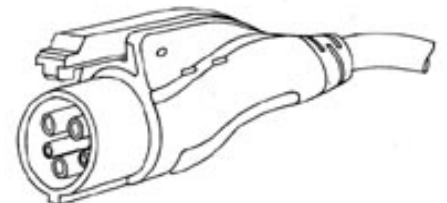

<b>PRIORITY NA</b>		
--------------------	--	--

<b>DESIGN NUMBER</b>	252549	
<b>CLASS</b>	13-03	
<b>1)GENERAL CABLE TECHNOLOGIES CORPORATION, A CORPORATION ORGANIZED AND EXISTING UNDER THE LAWS OF DELAWARE, U.S.A., OF 4 TESSENEER DRIVE, HIGHLAND HEIGHTS, KENTUCKY 41076, UNITED STATES OF AMERICA</b>		
<b>DATE OF REGISTRATION</b>	20/03/2013	
<b>TITLE</b>	ELECTRICAL CONNECTOR	
<b>PRIORITY</b>		
<b>PRIORITY NUMBER</b>	<b>DATE</b>	<b>COUNTRY</b>
29/432,863	21/09/2012	U.S.A.

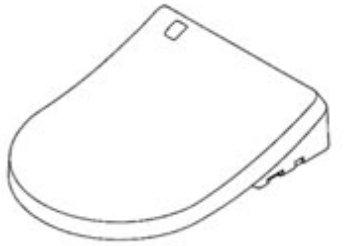

<b>DESIGN NUMBER</b>	251953		
<b>CLASS</b>	15-03		
<b>1)RAJIV MEHTANI AN INDIAN CITIZEN, RESIDING AT HOUSE NO. 76, NYAI PURI, OPPOSITE KARNAL STADIUM, MALL ROAD, KARNAL-132001, HARYANA, INDIA AND</b>			
RAMESH KUMAR AN INDIAN CITIZEN, RESIDING AT VILLAGE GAMRRI, TEHSIL-GOHANA, DISTRICT-SONIPAT, HARYANA-131301, INDIA			
<b>DATE OF REGISTRATION</b>	01/03/2013		
<b>TITLE</b>	AGRICULTURAL IMPLEMENT		
<b>PRIORITY NA</b>			
<b>DESIGN NUMBER</b>	253880		
<b>CLASS</b>	03-01		
<b>1)FURLA S.P.A.</b>			
VIA BELLARIA, 3-5 I-40068 SAN LAZZARO DI SAVENA (BOLOGNA) ITALY, NATIONALITY: ITALY			
<b>DATE OF REGISTRATION</b>	15/05/2013		
<b>TITLE</b>	HANDBAG		
<b>PRIORITY</b>			
<b>PRIORITY NUMBER</b>	<b>DATE</b>	<b>COUNTRY</b>	
002187906-0001	20/02/2013	OHIM	
<b>DESIGN NUMBER</b>	255094		
<b>CLASS</b>	11-01		
<b>1)BULGARI S.P.A. A COMPANY ORGANIZED AND EXISTING UNDER THE LAWS OF ITALY,</b>			
OF THE ADDRESS LUNGOTEVERE MARZIO, 11, I-00186 ROMA, ITALY			
<b>DATE OF REGISTRATION</b>	09/07/2013		
<b>TITLE</b>	CHAIN WITH PENDANT SET		
<b>PRIORITY</b>			
<b>PRIORITY NUMBER</b>	<b>DATE</b>	<b>COUNTRY</b>	
713485701	11/01/2013	WIPO	

<b>DESIGN NUMBER</b>	248564		
<b>CLASS</b>	14-02		
<b>1)SAGAR K. CHANDRA, INDIAN NATIONAL, ADULT, RESIDING AT :</b> SADHNA COLONY, SIDDHI VINAYAK PARK, RANJIT SAGAR ROAD, STREET NO. 7, JAMNAGAR, GUJARAT STATE, INDIA			
<b>DATE OF REGISTRATION</b>	05/10/2012		
<b>TITLE</b>	LAPTOP PRINTER ASSEMBLY		
<b>PRIORITY NA</b>			
<b>DESIGN NUMBER</b>	244866		
<b>CLASS</b>	23-02		
<b>1)TOTO LTD.</b> 1-1, NAKASHIMA 2-CHOME, KOKURAKITA-KU, KITAKYUSHU-SHI, FUKUOKA 802-8601, JAPAN			
<b>DATE OF REGISTRATION</b>	27/04/2012		
<b>TITLE</b>	TOILET SEAT		
<b>PRIORITY</b>			
<b>PRIORITY NUMBER</b>	<b>DATE</b>	<b>COUNTRY</b>	
2011-025209	31/10/2011	JAPAN	
<b>DESIGN NUMBER</b>	255138		
<b>CLASS</b>	21-01		
<b>1)VOLVO TRUCK CORPORATION,</b> OF 40508 GOTEBOG, SWEDEN			
<b>DATE OF REGISTRATION</b>	11/07/2013		
<b>TITLE</b>	TOY TRUCK		
<b>PRIORITY</b>			
<b>PRIORITY NUMBER</b>	<b>DATE</b>	<b>COUNTRY</b>	
002179291-0001	06/02/2013	OHIM	



<b>DESIGN NUMBER</b>	254240		
<b>CLASS</b>	26-03		
<b>1)LEGERO LIGHTING INDIA PRIVATE LIMITED., A COMPANY REGISTERED UNDER THE LAWS OF INDIA, HAVING PRINCIPAL PLACE OF BUSINESS AT</b> C-95, SECTOR 2, NOIDA-201301			
<b>DATE OF REGISTRATION</b>	03/06/2013		
<b>TITLE</b>	LIGHTING FIXTURE		
<b>PRIORITY NA</b>			
<b>DESIGN NUMBER</b>	253718		
<b>CLASS</b>	09-01		
<b>1)SAVERGLASS, A FRENCH COMPANY OF</b> 3 RUE DE LA GARE, 60960 FEUQUIERES, FRANCE			
<b>DATE OF REGISTRATION</b>	08/05/2013		
<b>TITLE</b>	BOTTLE		
<b>PRIORITY</b>			
<b>PRIORITY NUMBER</b>	<b>DATE</b>	<b>COUNTRY</b>	
002139360-0001	20/11/2012	OHIM	
<b>DESIGN NUMBER</b>	253503		
<b>CLASS</b>	15-01		
<b>1)KAYABA INDUSTRY CO., LTD. OF</b> WORLD TRADE CENTER BLDG., 4-1, HAMAMATSU-CHO 2-CHOME, MINATO-KU, TOKYO 105-6111 JAPAN, A JAPANESE COMPANY			
<b>DATE OF REGISTRATION</b>	29/04/2013		
<b>TITLE</b>	CYLINDER COVER FOR AN ACTUATOR		
<b>PRIORITY</b>			
<b>PRIORITY NUMBER</b>	<b>DATE</b>	<b>COUNTRY</b>	
2012-27943	15/11/2012	JAPAN	

<b>DESIGN NUMBER</b>	255105	
<b>CLASS</b>	14-03	
<b>1)ABB AB, A SWEDISH COMPANY OF KOPPABERGSVAGEN 2, 721 83 VASTERAS, SWEDEN</b>		
<b>DATE OF REGISTRATION</b>	10/07/2013	
<b>TITLE</b>	COMMUNICATION MODULE FOR ELECTRICITY METERS	
<b>PRIORITY</b>		
<b>PRIORITY NUMBER</b>	<b>DATE</b>	<b>COUNTRY</b>
002165183-0004	11/01/2013	OHIM

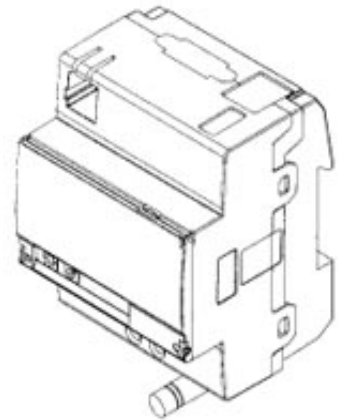



<b>DESIGN NUMBER</b>	255350	
<b>CLASS</b>	09-01	
<b>1)UNILEVER PLC, A COMPANY REGISTERED IN ENGLAND AND WALES UNDER COMPANY NO. 41424 OF UNILEVER HOUSE, 100 VICTORIA EMBANKMENT, LONDON, EC4Y 0DY, UNITED KINGDOM</b>		
<b>DATE OF REGISTRATION</b>	18/07/2013	
<b>TITLE</b>	BOTTLE WITHOUT CAP	
<b>PRIORITY</b>		
<b>PRIORITY NUMBER</b>	<b>DATE</b>	<b>COUNTRY</b>
29/444,293	29/01/2013	U.S.A.



<b>DESIGN NUMBER</b>	250962	
<b>CLASS</b>	15-07	
<b>1)MANITOWOC FOODSERVICE COMPANIES, LLC, A WISCONSIN LIMITED LIABILITY COMPANY OF 2400 SOUTH 44TH STREET, MANITOWOC, WISCONSIN 54220, UNITED STATES OF AMERICA</b>		
<b>DATE OF REGISTRATION</b>	11/01/2013	
<b>TITLE</b>	ICE MACHINE INTERFACE PANEL	
<b>PRIORITY NA</b>		



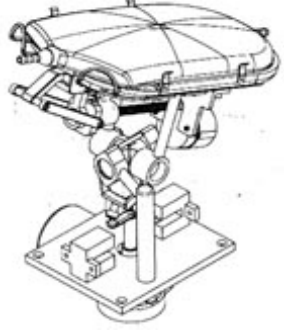

<b>DESIGN NUMBER</b>	253916		
<b>CLASS</b>	23-02		
<b>1)HALLMARK CREATIONS PRIVATE LIMITED (A COMPANY INCORPORATED UNDER THE COMPANIES ACT, 1956) HAVING ITS PRINCIPAL PLACE OF BUSINESS AT</b> PLOT NO. 7/8, SURVEY NO. 20, EVEREST INDUSTRIAL AREA, NEAR PERFECT (TATA) SHOWROOM, NATIONAL HIGHWAY NO. 8, VAVDI-DIST. RAJKOT-360001, GUJARAT-INDIA			
<b>DATE OF REGISTRATION</b>	17/05/2013		
<b>TITLE</b>	TOWEL ROD		
<b>PRIORITY NA</b>			
<b>DESIGN NUMBER</b>	256808		
<b>CLASS</b>	12-16		
<b>1)HERO MOTOCORP LIMITED, AN INDIAN COMPANY INCORPORATED UNDER THE COMPANIES ACT, HAVING ITS OFFICE AT</b> 34, COMMUNITY CENTRE, BASANT LOK, VASANT VIHAR, NEW DELHI-110057			
<b>DATE OF REGISTRATION</b>	26/09/2013		
<b>TITLE</b>	TAIL SECTION FOR A TWO WHEELED VEHICLE		
<b>PRIORITY NA</b>			
<b>DESIGN NUMBER</b>	254853		
<b>CLASS</b>	12-15		
<b>1)COMPAGNIE GENERALE DES ETABLISSEMENTS MICHELIN, A FRENCH COMPANY OF 12 COURS SABLON, FR-63000, CLERMONT-FERRAND, FRANCE, AND</b> MICHELIN RECHERCHE ET TECHNIQUE S.A., A SWISS COMPANY OF ROUTE LOUIS BRAILLE 10 - CH-1763 GRANGES-PACCOT, SWITZERLAND			
<b>DATE OF REGISTRATION</b>	28/06/2013		
<b>TITLE</b>	TIRE		
<b>PRIORITY</b>			
<b>PRIORITY NUMBER</b>	<b>DATE</b>	<b>COUNTRY</b>	
29/445,564	13/02/2013	U.S.A.	

<b>DESIGN NUMBER</b>	255137		
<b>CLASS</b>	12-08		
<b>1) VOLVO TRUCK CORPORATION, OF 40508 GÖTEBORG, SWEDEN</b>			
<b>DATE OF REGISTRATION</b>	11/07/2013		
<b>TITLE</b>	VEHICLE CAB		
<b>PRIORITY</b>			
<b>PRIORITY NUMBER</b>	<b>DATE</b>	<b>COUNTRY</b>	
002179291-0001	06/02/2013	OHIM	
<b>DESIGN NUMBER</b>	252205		
<b>CLASS</b>	28-03		
<b>1) UNILEVER PLC., A COMPANY REGISTERED IN ENGLAND AND WALES UNDER COMPANY NO.41424 OF UNILEVER HOUSE, 100 VICTORIA EMBANKMENT, LONDON, EC4Y 0DY, UNITED KINGDOM</b>			
<b>DATE OF REGISTRATION</b>	07/03/2013		
<b>TITLE</b>	SKIN AND HAIR EVALUATION DEVICE		
<b>PRIORITY</b>			
<b>PRIORITY NUMBER</b>	<b>DATE</b>	<b>COUNTRY</b>	
29/432,276	14/09/2012	U.S.A.	
<b>DESIGN NUMBER</b>	255411		
<b>CLASS</b>	24-01		
<b>1)STEMPEUTICS RESEARCH PRIVATE LIMITED, A COMPANY REGISTERED UNDER THE COMPANIES ACT, 1956 HAVING ITS REGISTERED OFFICE AT AKSHAY TECH PARK, 72 &amp;73, 2ND FLOOR EPIP ZONE, PHASE 1-AREA WHITEFIELD, BANGALORE 560066, KARNATAKA, INDIA, NATIONALITY: INDIAN</b>			
<b>DATE OF REGISTRATION</b>	26/07/2013		
<b>TITLE</b>	MEDICAL DEVICE FOR PROCESSING BIOLOGICAL SAMPLES		
<b>PRIORITY NA</b>			

<b>DESIGN NUMBER</b>	254925	
<b>CLASS</b>	09-01	
<b>1)JAGATJIT INDUSTRIES LIMITED, A COMPANY INCORPORATED UNDER THE INDIAN COMPANIES ACT, 1956, INDIAN COMPANY, P.O. JAGATJIT NAGAR-144802, DISTRICT-KAPURTHALA, PUNJAB</b>		
<b>DATE OF REGISTRATION</b>	02/07/2013	
<b>TITLE</b>	BOTTLE	
<b>PRIORITY NA</b>		
		
<b>DESIGN NUMBER</b>	248859	
<b>CLASS</b>	09-01	
<b>1)LODESTAR ANSTALT, A LIECHTENSTEIN COMPANY OF PO BOX 1150 LOVA-CENTER, VADUZ, FL-9490, LIECHTENSTEIN</b>		
<b>DATE OF REGISTRATION</b>	17/10/2012	
<b>TITLE</b>	BOTTLE	
<b>PRIORITY</b>		
<b>PRIORITY NUMBER</b>	<b>DATE</b>	<b>COUNTRY</b>
002030551-0002	20/04/2012	OHIM
		
<b>DESIGN NUMBER</b>	255351	
<b>CLASS</b>	26-04	
<b>1)ICEPIPE CORPORATION, A CORPORATION ORGANIZED AND EXISTING UNDER THE LAWS OF REPUBLIC OF KOREA WHO ARE KOREAN BY NATIONALITY AND WHOSE ADDRESS IS SUITE 1309, BYUCKSAN DIGITAL VALLEY 6-CHA, 481-4-GASAN-DONG, GEUMCHEON-GU, SEOUL 153-803, REPUBLIC OF KOREA</b>		
<b>DATE OF REGISTRATION</b>	18/07/2013	
<b>TITLE</b>	LED LIGHTING APPARATUS	
<b>PRIORITY</b>		
<b>PRIORITY NUMBER</b>	<b>DATE</b>	<b>COUNTRY</b>
30-2013-0003444	21/01/2013	REPUBLIC OF KOREA
		

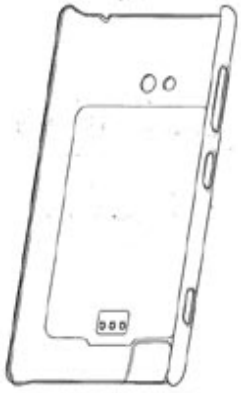
<b>DESIGN NUMBER</b>	250963		
<b>CLASS</b>	15-07		
<b>1)MANITOWOC FOODSERVICE COMPANIES, LLC, A WISCONSIN LIMITED LIABILITY COMPANY OF</b> 2400 SOUTH 44TH STREET, MANITOWOC, WISCONSIN 54220, UNITED STATES OF AMERICA			
<b>DATE OF REGISTRATION</b>	11/01/2013		
<b>TITLE</b>	ICE MACHINE INTERFACE PANEL		
<b>PRIORITY</b>			
<b>PRIORITY NUMBER</b>	<b>DATE</b>	<b>COUNTRY</b>	
29/426, 885	11/07/2012	U.S.A.	
<b>DESIGN NUMBER</b>	253511		
<b>CLASS</b>	19-06		
<b>1)MRS. ASHA VENUGOPAL, ADITYA VENUGOPAL, ROMI DIVAKARAN &amp; VENUGOPAL B. N., INDIAN NATIONAL, CARRYING ON BUSINESS UNDER THE NAME AND STYLE OF M/S. ZENITH METAPLAST PVT. LTD. (A COMPANY REGISTERED UNDER THE INDIAN COMPANIES ACT, 1956) HAVING ITS PRINCIPAL PLACE OF BUSINESS ADDRESS AT</b> F-18, MIDC, SATPUR, NASHIK-422007, MAHARASHTRA, INDIA			
<b>DATE OF REGISTRATION</b>	30/04/2013		
<b>TITLE</b>	PEN		
<b>PRIORITY NA</b>			
<b>DESIGN NUMBER</b>	253210		
<b>CLASS</b>	24-02		
<b>1)ROLLINS MEDICAL SOLUTIONS, INC.</b> 1930 VILLAGE CENTER CIR 3-314, LAS VEGAS, NV 89134, U.S.A. NATIONALITY: USA			
<b>DATE OF REGISTRATION</b>	17/04/2013		
<b>TITLE</b>	OXYGEN MASK		
<b>PRIORITY NA</b>			



<b>DESIGN NUMBER</b>	255943		
<b>CLASS</b>	14-03		
<b>1)NOKIA CORPORATION, A FINNISH CORPORATION, OF THE ADDRESS KEILALAHDENTIE 4, ESPOO, FINLAND 02150</b>			
<b>DATE OF REGISTRATION</b>	21/08/2013		
<b>TITLE</b>	MOBILE PHONE COVER		
<b>PRIORITY</b>			
<b>PRIORITY NUMBER</b>	<b>DATE</b>	<b>COUNTRY</b>	
29/446380	22/02/2013	U.S.A.	
<b>DESIGN NUMBER</b>	251670		
<b>CLASS</b>	26-05		
<b>1)MA DESIGN INDIA PRIVATE LIMITED, A COMPANY INCORPORATED IN INDIA HAVING ITS PRINCIPAL PLACE OF BUSINESS AT A-41, SECTOR-80, PHASE-II, NOIDA-201305, U.P. INDIA</b>			
<b>DATE OF REGISTRATION</b>	14/02/2013		
<b>TITLE</b>	BRACKET LIGHT		
<b>PRIORITY NA</b>			
<b>DESIGN NUMBER</b>	253793		
<b>CLASS</b>	23-04		
<b>1)HENKEL AG &amp; CO. KGAA, A GERMAN COMPANY OF HENKELSTRASSE 67, 40589 DÜSSELDORF, GERMANY</b>			
<b>DATE OF REGISTRATION</b>	13/05/2013		
<b>TITLE</b>	FRAGRANCE EVAPORATOR		
<b>PRIORITY</b>			
<b>PRIORITY NUMBER</b>	<b>DATE</b>	<b>COUNTRY</b>	
002139519	21/11/2012	OHIM	

<b>DESIGN NUMBER</b>	253976		
<b>CLASS</b>	12-15		
<b>1)SHANDONG LINGLONG TYRE CO. LTD. HAVING ITS OFFICE AT NO. 777 JINLONG ROAD, ZHAOYUAN CITY, SHANDONG, CHINA, ZIP CODE: 265400</b>			
<b>DATE OF REGISTRATION</b>	20/05/2013		
<b>TITLE</b>	TYRE		
<b>PRIORITY NA</b>			
<b>DESIGN NUMBER</b>	256819		
<b>CLASS</b>	12-16		
<b>1)HERO MOTOCORP LIMITED, AN INDIAN COMPANY INCORPORATED UNDER THE COMPANIES ACT, HAVING ITS OFFICE AT 34, COMMUNITY CENTRE, BASANT LOK, VASANT VIHAR, NEW DELHI-110057</b>			
<b>DATE OF REGISTRATION</b>	26/09/2013		
<b>TITLE</b>	FAIRING FOR A TWO WHEELED VEHICLE		
<b>PRIORITY NA</b>			
<b>DESIGN NUMBER</b>	255536		
<b>CLASS</b>	22-06		
<b>1)RECKITT BENCKISER (BRANDS) LIMITED, 103-105 BATH ROAD, SLOUGH BERKSHIRE, SL1 3UH, UNITED KINGDOM</b>			
<b>DATE OF REGISTRATION</b>	29/07/2013		
<b>TITLE</b>	INSECT REPELLENT DEVICE WITH REFILL		
<b>PRIORITY</b>			
<b>PRIORITY NUMBER</b>	<b>DATE</b>	<b>COUNTRY</b>	
002175349-0001	30/01/2013	OHIM	

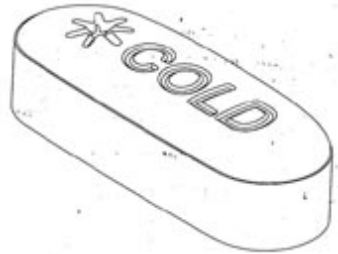

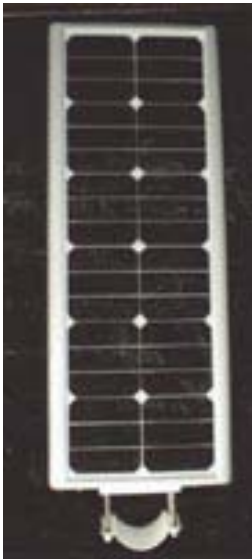
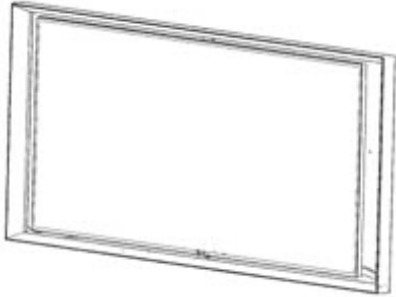
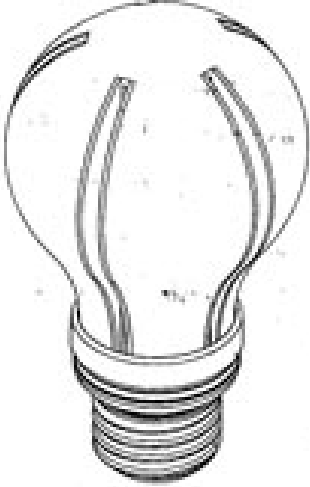
<b>DESIGN NUMBER</b>	246862		
<b>CLASS</b>	28-01		
<b>1)MCNEIL-PPC, INC., A CORPORATION OF THE STATE OF NEW JERSEY, OF 199 GRANDVIEW ROAD, SKILLMAN, NJ 08558, USA, AND JOHNSON &amp; JOHNSON INDUSTRIAL LTDA, A LIMITED LIABILITY COMPANY ORGANIZED AND EXISTING UNDER THE LAWS OF BRAZIL, OF RIGHTWAY PRESIDENTE DUTRA, KM 154, SAO JOSE DOS CAMPOS, SAO PAULO, BRAZIL</b>			
<b>DATE OF REGISTRATION</b>	01/08/2012		
<b>TITLE</b>	TABLET		
<b>PRIORITY</b>			
<b>PRIORITY NUMBER</b>	<b>DATE</b>	<b>COUNTRY</b>	
29/412,543	03/02/2012	U.S.A.	
<b>DESIGN NUMBER</b>	253516		
<b>CLASS</b>	19-06		
<b>1)MRS. ASHA VENUGOPAL, ADITYA VENUGOPAL, ROMI DIVAKARAN &amp; VENUGOPAL B. N., INDIAN NATIONAL, CARRYING ON BUSINESS UNDER THE NAME AND STYLE OF M/S. ZENITH METAPLAST PVT. LTD. (A COMPANY REGISTERED UNDER THE INDIAN COMPANIES ACT, 1956) HAVING ITS PRINCIPAL PLACE OF BUSINESS ADDRESS AT F-18, MIDC, SATPUR, NASHIK-422007, MAHARASHTRA, INDIA</b>			
<b>DATE OF REGISTRATION</b>	30/04/2013		
<b>TITLE</b>	PEN		
<b>PRIORITY NA</b>			
<b>DESIGN NUMBER</b>	256814		
<b>CLASS</b>	12-16		
<b>1)HERO MOTOCORP LIMITED, AN INDIAN COMPANY INCORPORATED UNDER THE COMPANIES ACT, HAVING ITS OFFICE AT 34, COMMUNITY CENTRE, BASANT LOK, VASANT VIHAR, NEW DELHI-110057</b>			
<b>DATE OF REGISTRATION</b>	26/09/2013		
<b>TITLE</b>	SPEEDOMETER MOUNTING FOR A TWO-WHEELER		
<b>PRIORITY NA</b>			

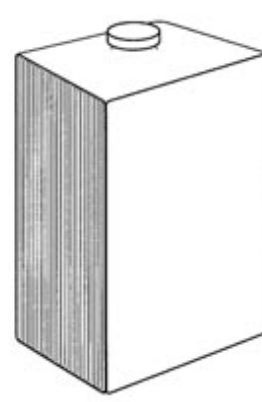
<b>DESIGN NUMBER</b>	254859		
<b>CLASS</b>	26-03		
<b>1)(1)FALGUN DEVENDRABHAI BHATT (2) SMT. RUJAL FALGUN BHATT BOTH INDIAN NATIONAL AND PARTNERS OF NEETY EURO ASIA SOLAR ENERGY (A PARTNERSHIP FIRM) HAVING THEIR PLACE OF BUSINESS AT BUNGLOW NO. 4, SHREE NAGAR SOCIETY, OPP. GOLDEN TRIANGLE, S.P. STADIUM ROAD, AHMEDABAD-380014 GUJARAT (INDIA)</b>			
<b>DATE OF REGISTRATION</b>	28/06/2013		
<b>TITLE</b>	SOLAR STREET LIGHT		
<b>PRIORITY NA</b>			
<b>DESIGN NUMBER</b>	254971		
<b>CLASS</b>	14-03		
<b>1)SAMSUNG ELECTRONICS CO., LTD. 129, SAMSUNG-RO, YEONGTONG-GU, SUWON-SI, GYEONGGI-DO, 443-742, REPUBLIC OF KOREA, A COMPANY OF REPUBLIC OF KOREA</b>			
<b>DATE OF REGISTRATION</b>	03/07/2013		
<b>TITLE</b>	TELEVISION UNIT		
<b>PRIORITY</b>			
<b>PRIORITY NUMBER</b>	<b>DATE</b>	<b>COUNTRY</b>	
30-2013-0000633	04/01/2013	REPUBLIC OF KOREA	
<b>DESIGN NUMBER</b>	253004		
<b>CLASS</b>	26-05		
<b>1)FOREVER BULB, LLC, OF 22680 SOUTH SILVER LAKE ROAD, GRANTSBURG, WI 54840, U.S., A U.S. COMPANY</b>			
<b>DATE OF REGISTRATION</b>	10/04/2013		
<b>TITLE</b>	LED LIGHT BULB		
<b>PRIORITY</b>			
<b>PRIORITY NUMBER</b>	<b>DATE</b>	<b>COUNTRY</b>	
29/434,303	11/10/2012	U.S.A.	

<b>DESIGN NUMBER</b>	255392		
<b>CLASS</b>	12-16		
<b>1)DEERE &amp; COMPANY, A US CORPORATION OF</b> ONE JOHN DEERE PLACE, MOLINE, ILLINOIS, 61265 - 8098, USA			
<b>DATE OF REGISTRATION</b>	22/07/2013		
<b>TITLE</b>	BUCKET FOR A VEHICLE		
<b>PRIORITY NA</b>			
<b>DESIGN NUMBER</b>	245975		
<b>CLASS</b>	09-01		
<b>1)THOMAS C. FORD, A CITIZEN OF U.S.A., C/O SHAPIRO &amp; COMPANY, C.P.A.,</b> 9229 SUNSET BLVD., SUITE 607, LOS ANGELES, CA 90069, USA			
<b>DATE OF REGISTRATION</b>	14/06/2012		
<b>TITLE</b>	FRAGRANCE BOTTLE		
<b>PRIORITY</b>			
<b>PRIORITY NUMBER</b>	<b>DATE</b>	<b>COUNTRY</b>	
29/408,569	14/12/2011	U.S.A.	
<b>DESIGN NUMBER</b>	255071		
<b>CLASS</b>	12-08		
<b>1)BERTAZZON 3B S.R.L.</b> VIA TREVIGIANA, 178-31020 SERNAGLIA (TV), ITALY, AN ITALIAN COMPANY			
<b>DATE OF REGISTRATION</b>	08/07/2013		
<b>TITLE</b>	BUMPER CAR		
<b>PRIORITY</b>			
<b>PRIORITY NUMBER</b>	<b>DATE</b>	<b>COUNTRY</b>	
002163626	09/01/2013	OHIM	

<b>DESIGN NUMBER</b>	255125		
<b>CLASS</b>	21-01		
<b>1)VOLVO TRUCK CORPORATION, OF 40508 GÖTEBORG, SWEDEN</b>			
<b>DATE OF REGISTRATION</b>	11/07/2013		
<b>TITLE</b>	TOY TRUCK		
<b>PRIORITY</b>			
<b>PRIORITY NUMBER</b>	<b>DATE</b>	<b>COUNTRY</b>	
002179036-0001	06/02/2013	OHIM	
<b>DESIGN NUMBER</b>	255198		
<b>CLASS</b>	03-01		
<b>1)VALENTINO S.P.A., A CORPORATION ORGANIZED AND EXISTING UNDER THE LAWS OF ITALY, OF VIA TURATI, 16/18, I-20121 MILANO, ITALY</b>			
<b>DATE OF REGISTRATION</b>	11/07/2013		
<b>TITLE</b>	BAG		
<b>PRIORITY</b>			
<b>PRIORITY NUMBER</b>	<b>DATE</b>	<b>COUNTRY</b>	
MI2013O000007	14/01/2013	ITALY	
<b>DESIGN NUMBER</b>	253637		
<b>CLASS</b>	12-16		
<b>1)WHEELS INDIA LIMITED, HAVING PLACE OF BUSINESS AT PADI, CHENNAI-600050, TAMILNADU, NATIONALITY OF INDIAN</b>			
<b>DATE OF REGISTRATION</b>	03/05/2013		
<b>TITLE</b>	WHEEL RIM FOR VEHICLES		
<b>PRIORITY NA</b>			

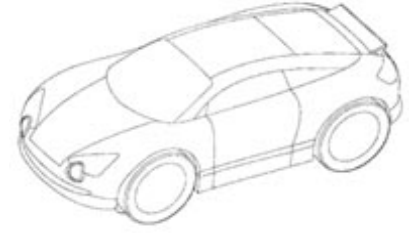
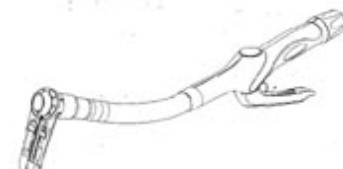
<b>DESIGN NUMBER</b>	252820		
<b>CLASS</b>	07-03		
<b>1)MA DESIGN INDIA PRIVATE LIMITED, A COMPANY INCORPORATED IN INDIA HAVING ITS PRINCIPAL PLACE OF BUSINESS</b> AT A-41, SECTOR-80, PHASE-II, NOIDA-201305, U.P. INDIA			
<b>DATE OF REGISTRATION</b>	03/04/2013		
<b>TITLE</b>	KNIFE		
<b>PRIORITY NA</b>			
<b>DESIGN NUMBER</b>	247909		
<b>CLASS</b>	21-01		
<b>1)INNOVATION FIRST, INC. ADDRESS AT</b> 1519 INTERSTATE 30 WEST GREENVILLE, TEXAS 75402, UNITED STATES OF AMERICA			
<b>DATE OF REGISTRATION</b>	14/09/2012		
<b>TITLE</b>	TOY CAR		
<b>PRIORITY</b>			
<b>PRIORITY NUMBER</b>	<b>DATE</b>	<b>COUNTRY</b>	
29/418,208	13/04/2012	U.S.A.	
<b>DESIGN NUMBER</b>	244065		
<b>CLASS</b>	24-01		
<b>1)ETHICON ENDO-SURGERY, INC.</b> 4545 CREEK ROAD, CINCINNATI, OH 45242, USA			
<b>DATE OF REGISTRATION</b>	22/03/2012		
<b>TITLE</b>	CIRCULAR STAPLER		
<b>PRIORITY</b>			
<b>PRIORITY NUMBER</b>	<b>DATE</b>	<b>COUNTRY</b>	
29/398666	23/09/2011	U.S.A.	

<b>DESIGN NUMBER</b>	246747	
<b>CLASS</b>	25-01	
<b>1)HUNTER DOUGLAS INDUSTRIES SWITZERLAND GMBH,</b> OF ADLIGENSWILERSTRASSE 27 6006 LUZEN SWITZERLAND, NATIONALITY : SWITZERLAND		
<b>DATE OF REGISTRATION</b>	26/07/2012	
<b>TITLE</b>	INTEGRATED PANEL CLIP	
<b>PRIORITY</b>		
<b>PRIORITY NUMBER</b>	<b>DATE</b>	<b>COUNTRY</b>
29/411,835	26/01/2012	U.S.A.

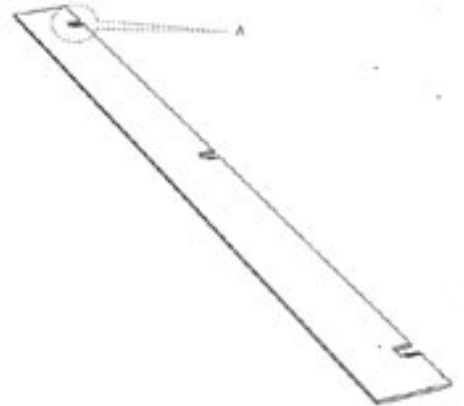





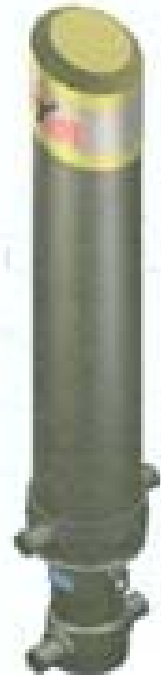

<b>DESIGN NUMBER</b>	250966	
<b>CLASS</b>	12-08	
<b>1)MR. MOHAMMAD ATIK KAZI AN INDIAN NATIONAL, HAVING</b> <b>THE OFFICE AT</b> PLOT NO. 54, SHIVAJI NAGAR, TEH-MOUDA, NAGPUR-441104, MAHARASTHRA, INDIA		
<b>DATE OF REGISTRATION</b>	14/01/2013	
<b>TITLE</b>	MOTOR CAR	
<b>PRIORITY NA</b>		

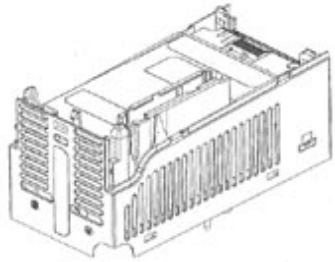

<b>DESIGN NUMBER</b>	252706	
<b>CLASS</b>	12-16	
<b>1)HYVA HOLDING B.V. OF THE ADDRESS</b> ONDERNEMINGSWEG 1, NL-2404 HM ALPHEN AAN DEN RIJN, THE NETHERLANDS		
<b>DATE OF REGISTRATION</b>	28/03/2013	
<b>TITLE</b>	CYLINDER FOR VEHICLES	
<b>PRIORITY</b>		
<b>PRIORITY NUMBER</b>	<b>DATE</b>	<b>COUNTRY</b>
002209940	27/03/2013	OHIM



<b>DESIGN NUMBER</b>	253513		
<b>CLASS</b>	19-06		
<b>1)MRS. ASHA VENUGOPAL, ADITYA VENUGOPAL, ROMI DIVAKARAN &amp; VENUGOPAL B. N., INDIAN NATIONAL, CARRYING ON BUSINESS UNDER THE NAME AND STYLE OF M/S. ZENITH METAPLAST PVT. LTD. (A COMPANY REGISTERED UNDER THE INDIAN COMPANIES ACT, 1956) HAVING ITS PRINCIPAL PLACE OF BUSINESS ADDRESS AT</b> F-18, MIDC, SATPUR, NASHIK-422007, MAHARASHTRA, INDIA			
<b>DATE OF REGISTRATION</b>	30/04/2013		
<b>TITLE</b>	PEN		
<b>PRIORITY NA</b>			
<b>DESIGN NUMBER</b>	252277		
<b>CLASS</b>	14-02		
<b>1)ROCKWELL AUTOMATION ASIA PACIFIC BUSINESS CTR. PTE., LTD., 2 CORPORATION ROAD, CORPORATION PLACE, SINGAPORE 618494 SG</b>			
<b>DATE OF REGISTRATION</b>	13/03/2013		
<b>TITLE</b>	INDUSTRIAL CONTROL COMPONENT MALE CONNECTOR INTERFACE		
<b>PRIORITY</b>			
<b>PRIORITY NUMBER</b>	<b>DATE</b>	<b>COUNTRY</b>	
29/432,421	14/09/2012	U.S.A.	
<b>DESIGN NUMBER</b>	255431		
<b>CLASS</b>	24-01		
<b>1)MAQUET CRITICAL CARE AB; A SWEDISH COMPANY OF RÖNTGENVÄGEN 2, SE-171 54 SOLNA, SWEDEN</b>			
<b>DATE OF REGISTRATION</b>	26/07/2013		
<b>TITLE</b>	VENTILATOR FOR PATIENT CARE		
<b>PRIORITY</b>			
<b>PRIORITY NUMBER</b>	<b>DATE</b>	<b>COUNTRY</b>	
002180356	07/02/2013	OHIM	

<b>DESIGN NUMBER</b>	255523		
<b>CLASS</b>	28-03		
<b>1)MR. MOHSIN ALI KHAN, WHOSE ADDRESS IS</b> 5TH FLOOR, PEARL COURT APARTMENT, GOKHLE MARG, LUCKNOW-226001, UTTAR PRADESH			
<b>DATE OF REGISTRATION</b>	26/07/2013		
<b>TITLE</b>	NAIL CLIPPER		
<b>PRIORITY NA</b>			
<b>DESIGN NUMBER</b>	255121		
<b>CLASS</b>	24-03		
<b>1)BLUE BELT TECHNOLOGIES, INC., A COMPANY ORGANIZED AND EXISTING UNDER THE LAW OF USA,</b> OF 2828 LIBERTY AVENUE, SUITE 100, PITTSBURGH, PENNSYLVANIA 15222, UNITED STATES OF AMERICA			
<b>DATE OF REGISTRATION</b>	10/07/2013		
<b>TITLE</b>	KNEE IMPLANT		
<b>PRIORITY</b>			
<b>PRIORITY NUMBER</b>	<b>DATE</b>	<b>COUNTRY</b>	
29/441,893	10/01/2013	U.S.A.	
<b>DESIGN NUMBER</b>	255221		
<b>CLASS</b>	23-01		
<b>1)BHARATBHAI RATIBHAI DHARAIYA, INDIVIDUAL, AN INDIAN NATIONAL,</b> ADD.- 184, LAXMI NAGAR, SIDSAR ROAD, NEAR SPORT COMPLEX, BHAVNAGAR-364002, GUJARAT, INDIA			
<b>DATE OF REGISTRATION</b>	15/07/2013		
<b>TITLE</b>	PRESSURE REDUCER VALVES FOR GAS		
<b>PRIORITY NA</b>			



<b>DESIGN NUMBER</b>	256464		
<b>CLASS</b>	26-01		
<b>1)MA DESIGN INDIA PRIVATE LIMITED, A COMPANY INCORPORATED IN INDIA HAVING ITS PRINCIPAL PLACE OF BUSINESS AT A-41, SECTOR-80, PHASE-II, NOIDA-201305, U.P. INDIA</b>			
<b>DATE OF REGISTRATION</b>	16/09/2013		
<b>TITLE</b>	CANDLE HOLDER		
<b>PRIORITY NA</b>			
<b>DESIGN NUMBER</b>	255084		
<b>CLASS</b>	12-08		
<b>1)EICHER POLARIS PRIVATE LIMITED, A COMPANY ORGANIZED UNDER THE LAWS OF INDIA, OF 3RD FLOOR, SELECT CITYWALK, A-3 DISTRICT CENTRE, SAKET, NEW DELHI-110017, INDIA</b>			
<b>DATE OF REGISTRATION</b>	09/07/2013		
<b>TITLE</b>	UTILITY VEHICLE		
<b>PRIORITY</b>			
<b>PRIORITY NUMBER</b>	<b>DATE</b>	<b>COUNTRY</b>	
29/441,815	09/01/2013	U.S.A.	
<b>DESIGN NUMBER</b>	250964		
<b>CLASS</b>	15-07		
<b>1)MANITOWOC FOODSERVICE COMPANIES, LLC, A WISCONSIN LIMITED LIABILITY COMPANY OF 2400 SOUTH 44TH STREET, MANITOWOC, WISCONSIN 54220, UNITED STATES OF AMERICA</b>			
<b>DATE OF REGISTRATION</b>	11/01/2013		
<b>TITLE</b>	ICE MACHINE INTERFACE PANEL		
<b>PRIORITY</b>			
<b>PRIORITY NUMBER</b>	<b>DATE</b>	<b>COUNTRY</b>	
29/426, 885	11/07/2012	U.S.A.	

<b>DESIGN NUMBER</b>	252275	
<b>CLASS</b>	14-02	
1)ROCKWELL AUTOMATION ASIA PACIFIC BUSINESS CTR. PTE., LTD., 2 CORPORATION ROAD, CORPORATION PLACE, SINGAPORE 618494 SG		
<b>DATE OF REGISTRATION</b>	13/03/2013	
<b>TITLE</b>	INDUSTRIAL CONTROL COMPONENT INTERFACE	
<b>PRIORITY</b>		
<b>PRIORITY NUMBER</b>	<b>DATE</b>	<b>COUNTRY</b>
29/432,413	14/09/2012	U.S.A.

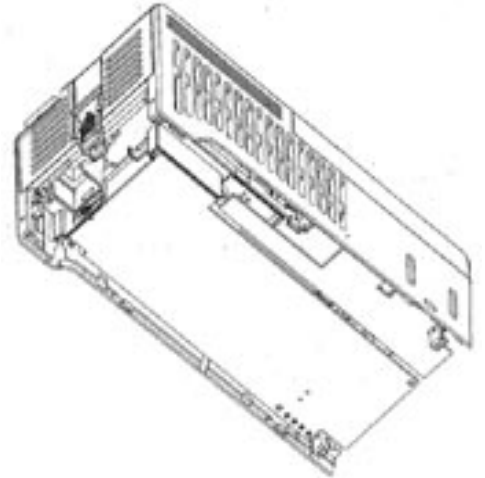



<b>DESIGN NUMBER</b>	256810	
<b>CLASS</b>	12-16	
1)HERO MOTOCORP LIMITED, AN INDIAN COMPANY INCORPORATED UNDER THE COMPANIES ACT, HAVING ITS OFFICE AT 34, COMMUNITY CENTRE, BASANT LOK, VASANT VIHAR, NEW DELHI-110057		
<b>DATE OF REGISTRATION</b>	26/09/2013	
<b>TITLE</b>	HEADLIGHT FOR TWO WHEELED VEHICLE	
<b>PRIORITY NA</b>		

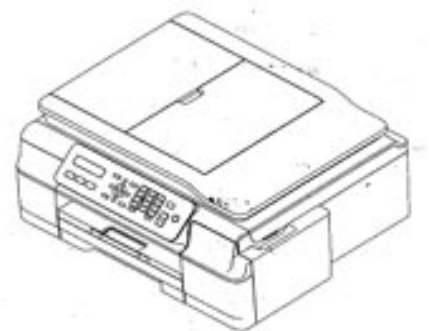

<b>DESIGN NUMBER</b>	254855	
<b>CLASS</b>	14-02	
1)BROTHER INDUSTRIES LTD., A CORPORATION ORGANIZED AND EXISTING UNDER THE LAWS OF JAPAN, 15-1, NAESHIRO-CHO, MIZUHO-KU, NAGOYA-SHI, AICHI-KEN, JAPAN		
<b>DATE OF REGISTRATION</b>	28/06/2013	
<b>TITLE</b>	PRINTER	
<b>PRIORITY</b>		
<b>PRIORITY NUMBER</b>	<b>DATE</b>	<b>COUNTRY</b>
2012-032070	28/12/2012	JAPAN

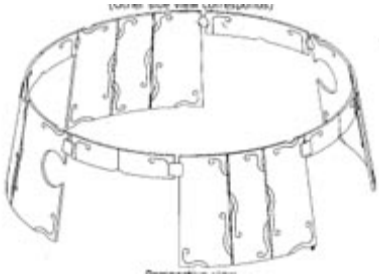

<b>DESIGN NUMBER</b>	255120		
<b>CLASS</b>	24-03		
<b>1)BLUE BELT TECHNOLOGIES, INC., A COMPANY ORGANIZED AND EXISTING UNDER THE LAW OF USA,</b> OF 2828 LIBERTY AVENUE, SUITE 100, PITTSBURGH, PENNSYLVANIA 15222, UNITED STATES OF AMERICA			
<b>DATE OF REGISTRATION</b>	10/07/2013		
<b>TITLE</b>	KNEE IMPLANT		
<b>PRIORITY</b>			
PRIORITY NUMBER	DATE	COUNTRY	
29/441,893	10/01/2013	U.S.A.	
<b>DESIGN NUMBER</b>	256150		
<b>CLASS</b>	15-99		
<b>1)SANDVIK INTELLECTUAL PROPERTY AB OF</b> SE-811 81 SANDVIKEN, SWEDEN, A SWEDISH COMPANY			
<b>DATE OF REGISTRATION</b>	30/08/2013		
<b>TITLE</b>	LINER FOR CRUSHER		
<b>PRIORITY</b>			
PRIORITY NUMBER	DATE	COUNTRY	
001364632	20/03/2013	OHIM	
<b>DESIGN NUMBER</b>	254796		
<b>CLASS</b>	08-07		
<b>1)ATULBHAI NARSIBHAI PATEL SOLE PROPRIETOR OF PATEL BROTHERS OF</b> 266/3, G.I.D.C. PHASE-II, WADHWAN CITY-363035 DIST. SURENDRANAGAR (GUJARAT), INDIA, INDIAN NATIONAL			
<b>DATE OF REGISTRATION</b>	25/06/2013		
<b>TITLE</b>	SEAL		
<b>PRIORITY NA</b>			

<b>DESIGN NUMBER</b>	254345		
<b>CLASS</b>	12-16		
<b>1)RENAULT TRUCKS, A COMPANY ORGANIZED UNDER THE LAWS OF FRANCE, OF 99 ROUTE DE LYON, 69800 SAINT PRIEST, FRANCE</b>			
<b>DATE OF REGISTRATION</b>	06/06/2013		
<b>TITLE</b>	WINDSCREENS FOR VEHICLES		
<b>PRIORITY NA</b>			
<b>DESIGN NUMBER</b>	252813		
<b>CLASS</b>	11-02		
<b>1)MA DESIGN INDIA PRIVATE LIMITED, A COMPANY INCORPORATED IN INDIA HAVING ITS PRINCIPAL PLACE OF BUSINESS AT A-41, SECTOR-80, PHASE-II, NOIDA-201305, U.P. INDIA</b>			
<b>DATE OF REGISTRATION</b>	03/04/2013		
<b>TITLE</b>	BOX (FOR JEWELLERY)		
<b>PRIORITY NA</b>			
<b>DESIGN NUMBER</b>	251853		
<b>CLASS</b>	14-03		
<b>1)KABUSHIKI KAISHA TOSHIBA, A JAPANESE CORPORATION, MANUFACTURERS, OF 1-1, SHIBAURA 1-CHOME, MINATO-KU, TOKYO, JAPAN</b>			
<b>DATE OF REGISTRATION</b>	25/02/2013		
<b>TITLE</b>	TELEVISION		
<b>PRIORITY</b>			
<b>PRIORITY NUMBER</b>	<b>DATE</b>	<b>COUNTRY</b>	
2012-020585	28/08/2012	JAPAN	

<b>DESIGN NUMBER</b>	250515	
<b>CLASS</b>	14-03	
<b>1)MITSUBISHI ELECTRIC CORPORATION, A JAPANESE COMPANY ORGANIZED AND EXISTING UNDER THE LAWS OF JAPAN, MANUFACTURERS AND MERCHANTS, OF THE ADDRESS</b> 7-3, MARUNOUCHI 2-CHOME, CHIYODA-KU, TOKYO 100-8310, JAPAN		
<b>DATE OF REGISTRATION</b>	28/12/2012	
<b>TITLE</b>	REMOTE CONTROLLER FOR AIR CONDITIONER	
<b>PRIORITY</b>		
<b>PRIORITY NUMBER</b>	<b>DATE</b>	<b>COUNTRY</b>
2012-016593	12/07/2012	JAPAN



<b>DESIGN NUMBER</b>	255085	
<b>CLASS</b>	12-08	
<b>1)EICHER POLARIS PRIVATE LIMITED, A COMPANY ORGANIZED UNDER THE LAWS OF INDIA,</b> OF 3RD FLOOR, SELECT CITYWALK, A-3 DISTRICT CENTRE, SAKET, NEW DELHI-110017, INDIA		
<b>DATE OF REGISTRATION</b>	09/07/2013	
<b>TITLE</b>	UTILITY VEHICLE	
<b>PRIORITY</b>		
<b>PRIORITY NUMBER</b>	<b>DATE</b>	<b>COUNTRY</b>
29/441,815	09/01/2013	U.S.A.



<b>DESIGN NUMBER</b>	244750	
<b>CLASS</b>	24-01	
<b>1)ETHICON ENDO-SURGERY, INC.</b> 4545 CREEK ROAD, CINCINNATI, OH 45242, USA		
<b>DATE OF REGISTRATION</b>	23/04/2012	
<b>TITLE</b>	SURGICAL INSTRUMENT	
<b>PRIORITY</b>		
<b>PRIORITY NUMBER</b>	<b>DATE</b>	<b>COUNTRY</b>
29/404,676	24/10/2011	U.S.A.

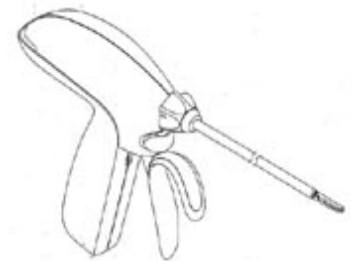



<b>DESIGN NUMBER</b>	224131	
<b>CLASS</b>	12-16	
<b>1)ESCORTS LIMITED</b> 15/5, KM, MATURA ROAD, FARIDABAD-121 003, HARYANA, INDIA,		
<b>DATE OF REGISTRATION</b>	03/08/2009	
<b>TITLE</b>	BONNET	
<b>PRIORITY NA</b>		

<b>DESIGN NUMBER</b>	249994		
<b>CLASS</b>	21-01		
<b>1)GRAVITY BOARD GAMES APS,</b> STÅRUPVEJ 15, ØSTRE HØJBY, 4573 HØJBY, DENMARK			
<b>DATE OF REGISTRATION</b>	07/12/2012		
<b>TITLE</b>	GAMEBOARD		
<b>PRIORITY</b>			
<b>PRIORITY NUMBER</b>	<b>DATE</b>	<b>COUNTRY</b>	
002053991-0006	07/06/2012	OHIM	

<b>DESIGN NUMBER</b>	253628		
<b>CLASS</b>	23-03		
<b>1)MR. DHITI TOWIWAT A CITIZEN OF THAILAND OF THE ADDRESS:</b> 163/71, PHAHONYOTHIN 32, KHWAENG LAT YAO, KHET CHATUCHAK, BANGKOK, THAILAND			
<b>DATE OF REGISTRATION</b>	02/05/2013		
<b>TITLE</b>	HEAT EXCHANGER		
<b>PRIORITY NA</b>			

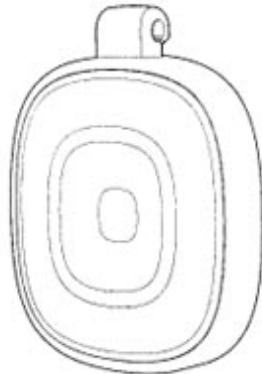
<b>DESIGN NUMBER</b>	253979		
<b>CLASS</b>	12-15		
<b>1)SHANDONG LINGLONG TYRE CO. LTD., HAVING ITS OFFICE AT NO. 777 JINLONG ROAD, ZHAOYUAN CITY, SHANDONG, CHINA, ZIP CODE: 265400</b>			
<b>DATE OF REGISTRATION</b>	20/05/2013		
<b>TITLE</b>	TYRE		
<b>PRIORITY NA</b>			
<b>DESIGN NUMBER</b>	255381		
<b>CLASS</b>	09-07		
<b>1)VARDHMAN PLASTOCHEM PVT. LTD., (AN INDIAN PRIVATE LIMITED COMPANY REGISTERED UNDER THE INDIAN COMPANIES ACT, 1956), OF 'KASTURI' SANGHAVI CORPORATE PARK, GOVANDI (EAST), MUMBAI- 400088. MAHARASHTRA, INDIA</b>			
<b>DATE OF REGISTRATION</b>	23/07/2013		
<b>TITLE</b>	CAP FOR BOTTLE		
<b>PRIORITY NA</b>			
<b>DESIGN NUMBER</b>	251852		
<b>CLASS</b>	14-03		
<b>1)KABUSHIKI KAISHA TOSHIBA, A JAPANESE CORPORATION, MANUFACTURERS, OF 1-1, SHIBAURA 1-CHOME, MINATO-KU, TOKYO, JAPAN</b>			
<b>DATE OF REGISTRATION</b>	25/02/2013		
<b>TITLE</b>	TELEVISION		
<b>PRIORITY</b>			
<b>PRIORITY NUMBER</b>	<b>DATE</b>	<b>COUNTRY</b>	
2012-020584	28/08/2012	JAPAN	

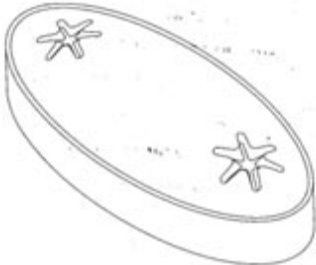
<b>DESIGN NUMBER</b>	254869		
<b>CLASS</b>	10-06		
<b>1)KONINKLIJKE PHILIPS N.V., A COMPANY ORGANIZED AND EXISTING UNDER THE LAWS OF THE KINGDOM OF THE NETHERLANDS, RESIDING AT EINDHOVEN,</b> WHOSE POST-OFFICE ADDRESS IS HIGH TECH CAMPUS 5, 5656 AE EINDHOVEN, THE NETHERLANDS			
<b>DATE OF REGISTRATION</b>	28/06/2013		
<b>TITLE</b>	MOBILE ALARM BUTTON		
<b>PRIORITY</b>			
<b>PRIORITY NUMBER</b>	<b>DATE</b>	<b>COUNTRY</b>	
002162610-0003	07/01/2013	OHIM	
<b>DESIGN NUMBER</b>	254822		
<b>CLASS</b>	12-05		
<b>1)ACTION CONSTRUCTION EQUIPMENT LTD.,</b> OF DHUDHOLLA LINK ROAD, VILLAGE DHUDHOLLA, PALWAL, HARYANA-121102, INDIA, AN INDIAN COMPANY			
<b>DATE OF REGISTRATION</b>	26/06/2013		
<b>TITLE</b>	LOADING TROLLEY OF CRANE		
<b>PRIORITY NA</b>			
<b>DESIGN NUMBER</b>	246860		
<b>CLASS</b>	28-01		
<b>1)MCNEIL-PPC, INC., A CORPORATION OF THE STATE OF NEW JERSEY, OF 199 GRANDVIEW ROAD, SKILLMAN, NJ 08558, USA, AND JOHNSON &amp; JOHNSON INDUSTRIAL LTDA, A LIMITED LIABILITY COMPANY ORGANIZED AND EXISTING UNDER THE LAWS OF BRAZIL,</b> OF RIGHTWAY PRESIDENTE DUTRA, KM 154, SAO JOSE DOS CAMPOS, SAO PAULO, BRAZIL			
<b>DATE OF REGISTRATION</b>	01/08/2012		
<b>TITLE</b>	TABLET		
<b>PRIORITY</b>			
<b>PRIORITY NUMBER</b>	<b>DATE</b>	<b>COUNTRY</b>	
29/412,543	03/02/2012	U.S.A.	
			



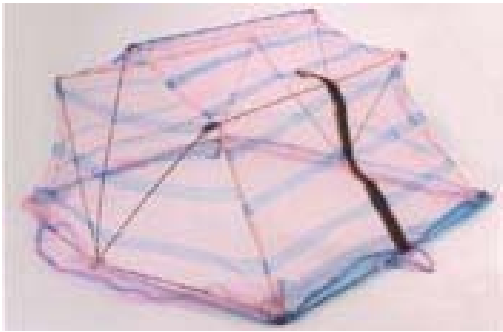

<b>DESIGN NUMBER</b>	245570		
<b>CLASS</b>	09-01		
<b>1)KAHLUA AG., A SWISS COMPANY, C/O TESTATORIS AG, TOPFERSTRASSE 5, 6004 LUCERNE, SWITZERLAND</b>			
<b>DATE OF REGISTRATION</b>	25/05/2012		
<b>TITLE</b>	BOTTLE		
<b>PRIORITY NA</b>			
<b>DESIGN NUMBER</b>	252707		
<b>CLASS</b>	12-16		
<b>1)HYVA HOLDING B.V. OF THE ADDRESS ONDERNEMINGSWEG 1, NL-2404 HM ALPHEN AAN DEN RIJN, THE NETHERLANDS</b>			
<b>DATE OF REGISTRATION</b>	28/03/2013		
<b>TITLE</b>	CYLINDER AND WET KIT ASSEMBLY FOR VEHICLES		
<b>PRIORITY</b>			
<b>PRIORITY NUMBER</b>	<b>DATE</b>	<b>COUNTRY</b>	
002209940	27/03/2013	OHIM	
<b>DESIGN NUMBER</b>	252278		
<b>CLASS</b>	14-02		
<b>1)ROCKWELL AUTOMATION ASIA PACIFIC BUSINESS CTR. PTE., LTD., 2 CORPORATION ROAD, CORPORATION PLACE, SINGAPORE 618494 SG</b>			
<b>DATE OF REGISTRATION</b>	13/03/2013		
<b>TITLE</b>	INDUSTRIAL CONTROL COMPONENT FEMALE CONNECTOR INTERFACE		
<b>PRIORITY</b>			
<b>PRIORITY NUMBER</b>	<b>DATE</b>	<b>COUNTRY</b>	
29/432,434	14/09/2012	U.S.A.	

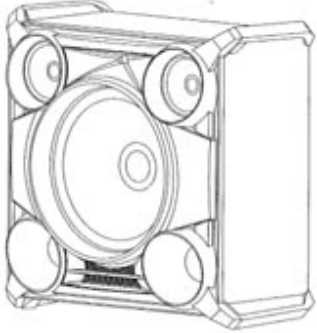
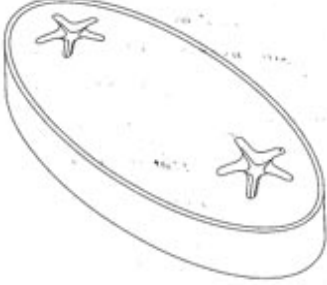

<b>DESIGN NUMBER</b>	255955	
<b>CLASS</b>	06-10	
<b>1)SHAILENDRA DWIVEDI SITUATED AT</b> 128/1/R-85, YASHODA NAGAR, KANPUR-208011 (U.P.) INDIA, BY NATIONALITY INDIAN OF ABOVE ADDRESS		
<b>DATE OF REGISTRATION</b>	22/08/2013	
<b>TITLE</b>	MOSQUITO NET	
<b>PRIORITY NA</b>		

<b>DESIGN NUMBER</b>	256588	
<b>CLASS</b>	08-06	
<b>1)ITALIK METALWARE PVT. LTD., G: 212-215, LODHIKA, G.I.D.C.,</b> <b>KALAWAD ROAD, METODA, RAJKOT-360003, STATE OF GUJARAT INDIA, /</b> A PRIVATE LIMITED COMPANY INCORPORATED UNDER INDIAN COMPANIES ACT., ABOVE ADDRESS		
<b>DATE OF REGISTRATION</b>	19/09/2013	
<b>TITLE</b>	HANDLE	
<b>PRIORITY NA</b>		

<b>DESIGN NUMBER</b>	254857	
<b>CLASS</b>	26-03	
<b>1)(1)FALGUN DEVENDRABHAI BHATT (2) SMT. RUJAL FALGUN BHATT</b> <b>BOTH INDIAN NATIONAL AND PARTNERS OF NEETY EURO ASIA SOLAR</b> <b>ENERGY (A PARTNERSHIP FIRM) HAVING THEIR PLACE OF BUSINESS AT</b> BUNGLOW NO. 4, SHREE NAGAR SOCIETY, OPP. GOLDEN TRIANGLE, S.P. STADIUM ROAD, AHMEDABAD-380014 GUJARAT (INDIA)		
<b>DATE OF REGISTRATION</b>	28/06/2013	
<b>TITLE</b>	SOLAR STREET LIGHT	
<b>PRIORITY NA</b>		

<b>DESIGN NUMBER</b>	254951		
<b>CLASS</b>	14-01		
<b>1)SAMSUNG ELECTRONICS CO., LTD., A KOREAN COMPANY, OF 129, SAMSUNG-RO, YEONGTONG-GU, SUWON-SI, GYEONGGI-DO, 443-742M REPUBLIC OF KOREA</b>			
<b>DATE OF REGISTRATION</b>	03/07/2013		
<b>TITLE</b>	SPEAKER		
<b>PRIORITY</b>			
<b>PRIORITY NUMBER</b>	<b>DATE</b>	<b>COUNTRY</b>	
30-2013-0000689	04/01/2013	REPUBLIC OF KOREA	
<b>DESIGN NUMBER</b>	246861		
<b>CLASS</b>	28-01		
<b>1)MCNEIL-PPC, INC., A CORPORATION OF THE STATE OF NEW JERSEY, OF 199 GRANDVIEW ROAD, SKILLMAN, NJ 08558, USA, AND JOHNSON &amp; JOHNSON INDUSTRIAL LTDA, A LIMITED LIABILITY COMPANY ORGANIZED AND EXISTING UNDER THE LAWS OF BRAZIL, OF RIGHTWAY PRESIDENTE DUTRA, KM 154, SAO JOSE DOS CAMPOS, SAO PAULO, BRAZIL</b>			
<b>DATE OF REGISTRATION</b>	01/08/2012		
<b>TITLE</b>	TABLET		
<b>PRIORITY</b>			
<b>PRIORITY NUMBER</b>	<b>DATE</b>	<b>COUNTRY</b>	
29/412,543	03/02/2012	U.S.A.	
<b>DESIGN NUMBER</b>	252712		
<b>CLASS</b>	12-16		
<b>1)HYVA HOLDING B.V. OF THE ADDRESS ONDERNEMINGSWEG 1, NL-2404 HM ALPHEN AAN DEN RIJN, THE NETHERLANDS</b>			
<b>DATE OF REGISTRATION</b>	28/03/2013		
<b>TITLE</b>	LIFTING BRACKET FOR VEHICLES		
<b>PRIORITY</b>			
<b>PRIORITY NUMBER</b>	<b>DATE</b>	<b>COUNTRY</b>	
002209940	27/03/2013	OHIM	

<b>DESIGN NUMBER</b>	256813		
<b>CLASS</b>	12-16		
<b>1)HERO MOTOCORP LIMITED, AN INDIAN COMPANY INCORPORATED UNDER THE COMPANIES ACT, HAVING ITS OFFICE AT</b> 34, COMMUNITY CENTRE, BASANT LOK, VASANT VIHAR, NEW DELHI-110057			
<b>DATE OF REGISTRATION</b>	26/09/2013		
<b>TITLE</b>	REARVIEW MIRROR FOR A MOTORCYCLE		
<b>PRIORITY NA</b>			
<b>DESIGN NUMBER</b>	256033		
<b>CLASS</b>	23-04		
<b>1)SPAL AUTOMOTIVE S.R.L.,</b> VIA PER CARPI, 26/B, 42015 CORREGGIO (REGGIO EMILIA), ITALY, AN ITALIAN COMPANY			
<b>DATE OF REGISTRATION</b>	23/08/2013		
<b>TITLE</b>	FAN UNIT		
<b>PRIORITY</b>			
<b>PRIORITY NUMBER</b>	<b>DATE</b>	<b>COUNTRY</b>	
001362297-0001	26/02/2013	OHIM	
<b>DESIGN NUMBER</b>	254970		
<b>CLASS</b>	07-01		
<b>1)HAMILTON HOUSEWARES PVT. LTD. AN INDIAN COMPANY INCORPORATED UNDER THE COMPANIES ACT 1956, HAVING REGISTERED OFFICE AT</b> KAISER-I-HIND BLDG., 3RD FLOOR, CURRIMBHOY ROAD, BALLARD ESTATE, MUMBAI 400001, MAHARASHTRA, INDIA			
<b>DATE OF REGISTRATION</b>	03/07/2013		
<b>TITLE</b>	PLATE		
<b>PRIORITY NA</b>			

<b>DESIGN NUMBER</b>	249991		
<b>CLASS</b>	21-01		
<b>1)GRAVITY BOARD GAMES APS, STÅRUPVEJ 15, ØSTRE HØJBY, 4573 HØJBY, DENMARK</b>			
<b>DATE OF REGISTRATION</b>	07/12/2012		
<b>TITLE</b>	GAMEBOARD		
<b>PRIORITY</b>			
<b>PRIORITY NUMBER</b>	<b>DATE</b>	<b>COUNTRY</b>	
002053991 - 0003	07/06/2012	OHIM	
<b>DESIGN NUMBER</b>	253602		
<b>CLASS</b>	15-03		
<b>1)KHOKHAR AGRICULTURE WORKS, NEAR MAHARAJA PALACE, DABWALI ROAD, SIRSA-125104 (INDIA)</b> AN INDIAN PROPRIETORSHIP FIRM WHOSE PROPRIETOR IS :- DARSHAN SINGH BEING INDIAN NATIONALS OF THE ABOVE ADDRESS			
<b>DATE OF REGISTRATION</b>	01/05/2013		
<b>TITLE</b>	THRASHER		
<b>PRIORITY NA</b>			
<b>DESIGN NUMBER</b>	253292		
<b>CLASS</b>	03-01		
<b>1)GLAXO GROUP LIMITED ENGLAND, GREAT BRITAIN OF THE ADDRESS</b> 980 GREAT WEST ROAD, BRENTFORD, MIDDLESEX TW8 9GS, UNITED KINGDOM			
<b>DATE OF REGISTRATION</b>	22/04/2013		
<b>TITLE</b>	CASE FOR AN INHALER		
<b>PRIORITY</b>			
<b>PRIORITY NUMBER</b>	<b>DATE</b>	<b>COUNTRY</b>	
GB 4027109	23/10/2012	U.K.	

<b>DESIGN NUMBER</b>	249485
<b>CLASS</b>	09-01
<b>1)SRI VISION POLYMER,</b> 34 TINY SECTOR, INDUSTRIAL AREA GUINDY, CHENNAI-600032	
<b>DATE OF REGISTRATION</b>	15/11/2012
<b>TITLE</b>	BOTTLE HOLDER
<b>PRIORITY NA</b>	





<b>DESIGN NUMBER</b>	254992
<b>CLASS</b>	15-02
<b>1)WEIR MINERALS INDIA-ENSCI. CO,</b> A/01/02, PLATINUM CITY, HMT ROAD, YESHWANTPUR, BANGALORE-560076, KARNATAKA, NATIONALITY-INDIAN	
<b>DATE OF REGISTRATION</b>	04/07/2013
<b>TITLE</b>	PERISTALTIC PUMP
<b>PRIORITY NA</b>	



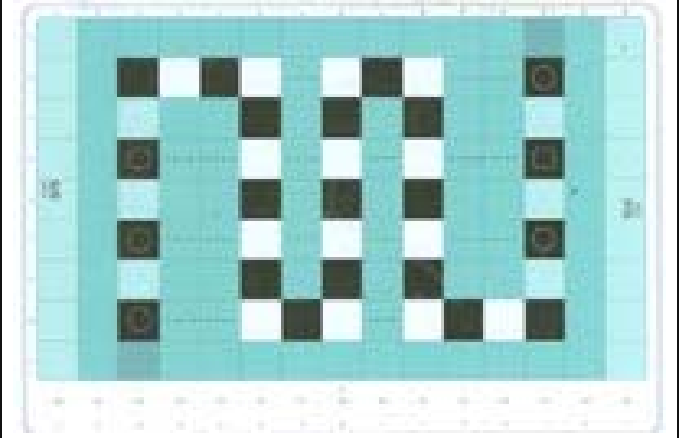

<b>DESIGN NUMBER</b>	249993	
<b>CLASS</b>	21-01	
<b>1)GRAVITY BOARD GAMES APS,</b> STÅRUPVEJ 15, ØSTRE HØJBY, 4573 HØJBY, DENMARK		
<b>DATE OF REGISTRATION</b>	07/12/2012	
<b>TITLE</b>	GAMEBOARD	
<b>PRIORITY</b>		
<b>PRIORITY NUMBER</b>	<b>DATE</b>	<b>COUNTRY</b>
002053991 - 0005	07/06/2012	OHIM

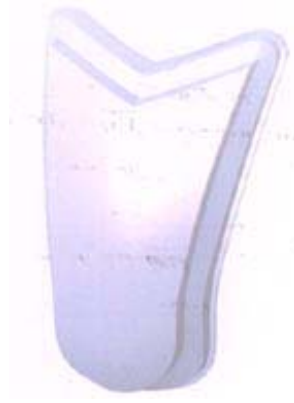

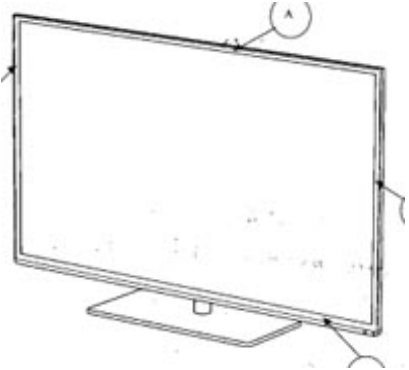
<b>DESIGN NUMBER</b>	253627	
<b>CLASS</b>	23-03	
<b>1)MR. DHITI TOWIWAT A CITIZEN OF THAILAND OF THE ADDRESS: 163/71, PHAHONYOTHIN 32, KHWAENG LAT YAO, KHET CHATUCHAK, BANGKOK, THAILAND</b>		
<b>DATE OF REGISTRATION</b>	02/05/2013	
<b>TITLE</b>	HEAT EXCHANGER	
<b>PRIORITY NA</b>		
<b>DESIGN NUMBER</b>	254327	
<b>CLASS</b>	12-16	
<b>1)RENAULT TRUCKS, A COMPANY ORGANIZED UNDER THE LAWS OF FRANCE, OF 99 ROUTE DE LYON, 69800 SAINT PRIEST, FRANCE</b>		
<b>DATE OF REGISTRATION</b>	06/06/2013	
<b>TITLE</b>	DECORATIVE FITTING FOR VEHICLE	
<b>PRIORITY NA</b>		
<b>DESIGN NUMBER</b>	253977	
<b>CLASS</b>	12-15	
<b>1)SHANDONG LINGLONG TYRE CO. LTD., HAVING ITS OFFICE AT NO. 777 JINLONG ROAD, ZHAOYUAN CITY, SHANDONG, CHINA, ZIP CODE: 265400</b>		
<b>DATE OF REGISTRATION</b>	20/05/2013	
<b>TITLE</b>	TYRE	
<b>PRIORITY NA</b>		

<b>DESIGN NUMBER</b>	256820		
<b>CLASS</b>	12-16		
<b>1)HERO MOTOCORP LIMITED, AN INDIAN COMPANY INCORPORATED UNDER THE COMPANIES ACT, HAVING ITS OFFICE AT</b> 34, COMMUNITY CENTRE, BASANT LOK, VASANT VIHAR, NEW DELHI-110057			
<b>DATE OF REGISTRATION</b>	26/09/2013		
<b>TITLE</b>	HEADLIGHT LENS FOR A TWO WHEELED VEHICLE		
<b>PRIORITY NA</b>			
<b>DESIGN NUMBER</b>	255537		
<b>CLASS</b>	22-06		
<b>1)RECKITT BENCKISER (BRANDS) LIMITED,</b> 103-105 BATH ROAD, SLOUGH BERKSHIRE, SL1 3UH, UNITED KINGDOM			
<b>DATE OF REGISTRATION</b>	29/07/2013		
<b>TITLE</b>	INSECT REPELLENT DEVICE WITH REFILL		
<b>PRIORITY</b>			
<b>PRIORITY NUMBER</b>	<b>DATE</b>	<b>COUNTRY</b>	
002175349-0002	30/01/2013	OHIM	
<b>DESIGN NUMBER</b>	251851		
<b>CLASS</b>	14-03		
<b>1)KABUSHIKI KAISHA TOSHIBA, A JAPANESE CORPORATION, MANUFACTURERS, OF</b> 1-1, SHIBAURA 1-CHOME, MINATO-KU, TOKYO, JAPAN			
<b>DATE OF REGISTRATION</b>	25/02/2013		
<b>TITLE</b>	TELEVISION		
<b>PRIORITY</b>			
<b>PRIORITY NUMBER</b>	<b>DATE</b>	<b>COUNTRY</b>	
2012-020583	28/08/2012	JAPAN	

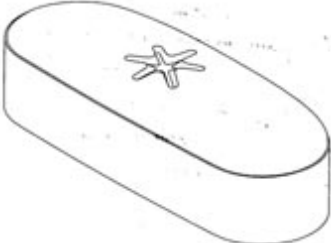

<b>DESIGN NUMBER</b>	254868		
<b>CLASS</b>	10-06		
<b>1)KONINKLIJKE PHILIPS N.V., A COMPANY ORGANIZED AND EXISTING UNDER THE LAWS OF THE KINGDOM OF THE NETHERLANDS, RESIDING AT EINDHOVEN,</b> WHOSE POST-OFFICE ADDRESS IS HIGH TECH CAMPUS 5, 5656 AE EINDHOVEN, THE NETHERLANDS			
<b>DATE OF REGISTRATION</b>	28/06/2013		
<b>TITLE</b>	COMMUNICATOR FOR MOBILE ALARM PENDANT		
<b>PRIORITY</b>			
<b>PRIORITY NUMBER</b>	<b>DATE</b>	<b>COUNTRY</b>	
002162610-0002	07/01/2013	OHIM	
<b>DESIGN NUMBER</b>	254821		
<b>CLASS</b>	12-05		
<b>1)ACTION CONSTRUCTION EQUIPMENT LTD.,</b> OF DHUDHOLLA LINK ROAD, VILLAGE DHUDHOLLA, PALWAL, HARYANA-121102, INDIA, AN INDIAN COMPANY			
<b>DATE OF REGISTRATION</b>	26/06/2013		
<b>TITLE</b>	LOWER BRACKET STEEL STRUCTURE OF CRANE		
<b>PRIORITY NA</b>			
<b>DESIGN NUMBER</b>	246863		
<b>CLASS</b>	28-01		
<b>1)MCNEIL-PPC, INC., A CORPORATION OF THE STATE OF NEW JERSEY, OF 199 GRANDVIEW ROAD, SKILLMAN, NJ 08558, USA, AND JOHNSON &amp; JOHNSON INDUSTRIAL LTDA, A LIMITED LIABILITY COMPANY ORGANIZED AND EXISTING UNDER THE LAWS OF BRAZIL,</b> OF RIGHTWAY PRESIDENTE DUTRA, KM 154, SAO JOSE DOS CAMPOS, SAO PAULO, BRAZIL			
<b>DATE OF REGISTRATION</b>	01/08/2012		
<b>TITLE</b>	TABLET		
<b>PRIORITY</b>			
<b>PRIORITY NUMBER</b>	<b>DATE</b>	<b>COUNTRY</b>	
29/412,543	03/02/2012	U.S.A.	

<b>DESIGN NUMBER</b>	252352
<b>CLASS</b>	20-02
<b>1)ZIVELO LLC, AN INDIANA CORPORATION HAVING OFFICES AT 6508 E. MUSEUM BOULEVARD, GAS CITY, INDIANA 46933, USA</b>	
<b>DATE OF REGISTRATION</b>	15/03/2013
<b>TITLE</b>	KIOSK DISPLAY STAND

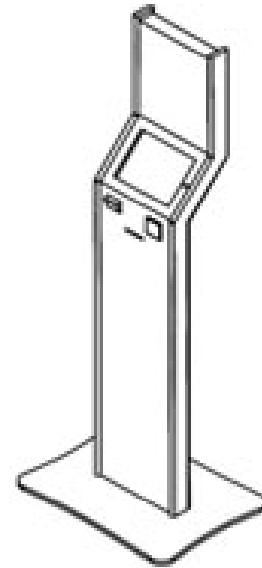

<b>PRIORITY</b>		
<b>PRIORITY NUMBER</b>	<b>DATE</b>	<b>COUNTRY</b>
29/432,548	17/09/2012	U.S.A.

<b>DESIGN NUMBER</b>	253290
<b>CLASS</b>	03-01
<b>1)GLAXO GROUP LIMITED , ENGLAND, GREAT BRITAIN 980 GREAT WEST ROAD, BRENTFORD, MIDDLESEX TX8 9GS, UNITED KINGDOM</b>	
<b>DATE OF REGISTRATION</b>	22/04/2013
<b>TITLE</b>	CASE FOR AN INHALER



<b>PRIORITY</b>		
<b>PRIORITY NUMBER</b>	<b>DATE</b>	<b>COUNTRY</b>
GB 4027107	23/10/2012	U.K.

<b>DESIGN NUMBER</b>	252753
<b>CLASS</b>	23-02
<b>1)KOHLER CO., A COMPANY ORGANIZED AND EXISTING UNDER THE LAW OF USA, OF 444 HIGHLAND DRIVE, KOHLER, WISCONSIN 53044, UNITED STATES OF AMERICA</b>	
<b>DATE OF REGISTRATION</b>	02/04/2013
<b>TITLE</b>	FLUSH HANDLE

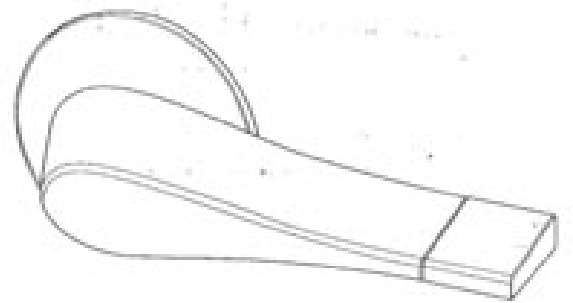

<b>PRIORITY</b>		
<b>PRIORITY NUMBER</b>	<b>DATE</b>	<b>COUNTRY</b>
29/433,633	02/10/2012	U.S.A.

<b>DESIGN NUMBER</b>	253971		
<b>CLASS</b>	12-15		
<b>1)SHANDONG LINGLONG TYRE CO. LTD. HAVING ITS OFFICE AT NO. 777 JINLONG ROAD, ZHAOYUAN CITY, SHANDONG, CHINA, ZIP CODE: 265400</b>			
<b>DATE OF REGISTRATION</b>	20/05/2013		
<b>TITLE</b>	TYRE		
<b>PRIORITY NA</b>			
<b>DESIGN NUMBER</b>	252353		
<b>CLASS</b>	20-02		
<b>1)ZIVELO LLC, AN INDIANA CORPORATION HAVING OFFICES AT 6508 E. MUSEUM BOULEVARD, GAS CITY, INDIANA 46933, USA</b>			
<b>DATE OF REGISTRATION</b>	15/03/2013		
<b>TITLE</b>	KIOSK DISPLAY STAND		
<b>PRIORITY</b>			
<b>PRIORITY NUMBER</b>	<b>DATE</b>	<b>COUNTRY</b>	
29/432,551	17/09/2012	U.S.A.	
<b>DESIGN NUMBER</b>	256707		
<b>CLASS</b>	15-04		
<b>1)DEERE &amp; COMPANY, A US CORPORATION OF ONE JOHN DEERE PLACE, MOLINE, ILLINOIS, 61265-8098 USA</b>			
<b>DATE OF REGISTRATION</b>	24/09/2013		
<b>TITLE</b>	EXCAVATOR		
<b>PRIORITY NA</b>			

<b>DESIGN NUMBER</b>	256817	
<b>CLASS</b>	12-16	
<b>1)HERO MOTOCORP LIMITED, A COMPANY INCORPORATED UNDER THE INDIAN COMPANIES ACT, HAVING ITS OFFICE AT 34, COMMUNITY CENTRE, BASANT LOK, VASANT VIHAR, NEW DELHI-110057</b>		
<b>DATE OF REGISTRATION</b>	26/09/2013	
<b>TITLE</b>	COWL FOR MOTORCYCLE	
<b>PRIORITY NA</b>		