

INTRODUCTION

In view of the recent amendment made in the Designs (Amendment) Rules, 2008 with effect from 17/06/2008, Publication of the matter relating to Designs is being published in the Official Journal of The Patent Office. This Journal is being published on weekly basis on every Friday covering the various proceedings on Designs as required according to the provisions of under Rule 22, 25, 27 and 39 of the Design (Amendment) Rules, 2008. All the enquiries on this Official Journal and other information as required by the public should be addressed to the Controller General of Patents, Designs & Trade Marks. Suggestions and comments are requested from all quarters so that the content can be enriched.

COPYRIGHT PUBLICATION

SL NO	CASE NUMBERS	RENEWED ON
1.	191956	27.01.2014
2.	192222	27.01.2014
3.	192224	27.01.2014
4.	192665	27.01.2014
5.	193359	24.01.2014
6.	193360	24.01.2014
7.	193371	24.01.2014
8.	194147	23.01.2014
9.	194265	23.01.2014
10.	194266	23.01.2014
11.	194267	23.01.2014
12.	194268	23.01.2014
13.	194269	23.01.2014
14.	194563	23.01.2014
15.	194778	23.01.2014
16.	193330	28.01.2014
17.	193332	29.01.2014



THE DESIGNS ACT 2000
SECTION 30
DESIGN ASSIGNMENT

The Design stands in the name of TOP ENERGY SAVING SYSTEM CORP. registered under the Designs Act, 2000 has been assigned in the Register of Designs in the name as follows:-

Design No.	Class	Name
239603	26-05	CHANG WAH ELECTROMATERIALS INC., OF 6F, NO. 16, EAST 7TH STREET, NAN-TZE EXPORT PROCESSING ZONE, KAOHSIUNG, TAIWAN (R.O.C.)

REGISTRATION OF DESIGNS

The following designs have been registered. They are now open for public inspection. In the following each entry the Date of Registration is shown. The Priority Number, Priority Date and Priority Country are also shown

DESIGN NUMBER	255176		
CLASS	03-01		
1)KANIKA SACHDEVA, AN INDIAN NATIONAL, 38, HAUZ KHAS VILLAGE, 3RD FLOOR, NEW DELHI-110016, INDIA			
DATE OF REGISTRATION	11/07/2013		
TITLE	PORTFOLIO BAG		
PRIORITY NA			
DESIGN NUMBER	255206		
CLASS	23-04		
1)DYSON TECHNOLOGY LIMITED, A COMPANY INCORPORATED UNDER THE LAWS OF THE UNITED KINGDOM, OF TETBURY HILL, MALMESBURY, WILTSHIRE, SN16 0RP, UNITED KINGDOM			
DATE OF REGISTRATION	12/07/2013		
TITLE	HUMIDIFIER		
PRIORITY			
PRIORITY NUMBER	DATE	COUNTRY	
001357941-0003	18/01/2013	OHIM	
DESIGN NUMBER	255321		
CLASS	06-07		
1)MA DESIGN INDIA PRIVATE LIMITED, A COMPANY INCORPORATED IN INDIA HAVING ITS PRINCIPAL PLACE OF BUSINESS AT A-41, SECTOR-80, PHASE-II, NOIDA-201305, U.P. INDIA			
DATE OF REGISTRATION	18/07/2013		
TITLE	PHOTO FRAME		
PRIORITY NA			

DESIGN NUMBER	255334	
CLASS	07-06	
1)MA DESIGN INDIA PRIVATE LIMITED, A COMPANY INCORPORATED IN INDIA HAVING ITS PRINCIPAL PLACE OF BUSINESS AT A-41, SECTOR-80, PHASE-II, NOIDA-201305, U.P. INDIA		
DATE OF REGISTRATION	18/07/2013	
TITLE	CASSEROLE HOLDER	
PRIORITY NA		

DESIGN NUMBER	254346	
CLASS	12-08	
1)RENAULT TRUCKS, A COMPANY ORGANIZED UNDER THE LAWS OF FRANCE, OF 99 ROUTE DE LYON, 69800 SAINT PRIEST, FRANCE		
DATE OF REGISTRATION	06/06/2013	
TITLE	TRUCK	
PRIORITY NA		

DESIGN NUMBER	255810	
CLASS	07-02	
1)MRS. SIMPLE (PROPRIETOR), NATIONALITY INDIAN TRADING AS TULIP INDUSTRIES (THIS IS A PROPRIETORSHIP FIRM) WHOES ADDRESS IS C-130, SECTOR-3, BAWANA INDUSTRIAL AREA, DELHI-110039 (INDIA)		
DATE OF REGISTRATION	14/08/2013	
TITLE	CASSEROLE	
PRIORITY NA		

DESIGN NUMBER	251129	
CLASS	07-02	
1)DART INDUSTRIES INC., A CORPORATION FOUNDED UNDER THE LAWS OF DELAWARE, U.S.A. OF 14901 SOUTH ORANGE BLOSSOM TRAIL, ORLANDO, FLORIDA 32837, USA		
DATE OF REGISTRATION	23/01/2013	
TITLE	CONTAINER FOR FOOD	
PRIORITY		
PRIORITY NUMBER	DATE	COUNTRY
29/421,561	16/08/2012	U.S.A.

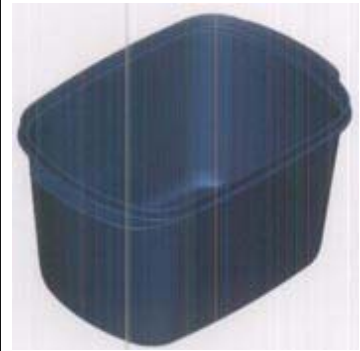

DESIGN NUMBER	251143	
CLASS	07-02	
1)DART INDUSTRIES INC., A CORPORATION FOUNDED UNDER THE LAWS OF DELAWARE, U.S.A. OF 14901 SOUTH ORANGE BLOSSOM TRAIL, ORLANDO, FLORIDA 32837, USA		
DATE OF REGISTRATION	23/01/2013	
TITLE	CONTAINER FOR FOOD	
PRIORITY		
PRIORITY NUMBER	DATE	COUNTRY
29/421,570	16/08/2012	U.S.A.



DESIGN NUMBER	251196	
CLASS	13-03	
1)EMERSON ELECTRIC CO., A CORPORATION ORGANIZED UNDER THE LAWS OF THE STATE OF MISSOURI, 8000, WEST FLORISSANT, ST. LOUIS, MISSOURI 63136, UNITED STATES OF AMERICA		
DATE OF REGISTRATION	24/01/2013	
TITLE	HERMETIC TERMINAL	
PRIORITY		
PRIORITY NUMBER	DATE	COUNTRY
29/429570	14/08/2012	U.S.A.

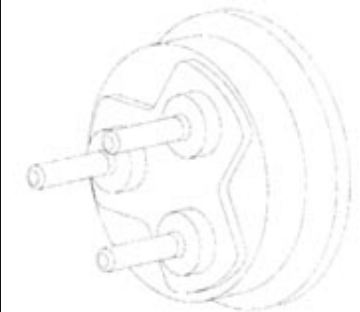

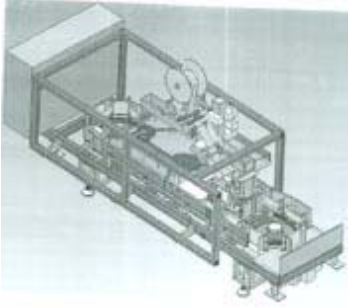
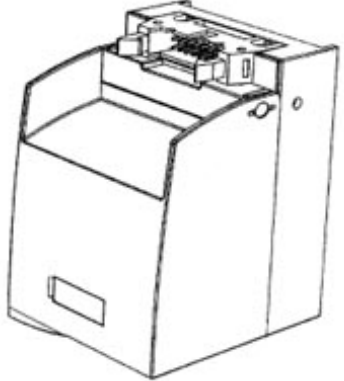

DESIGN NUMBER	255885		
CLASS	09-07		
1)EMAMI LIMITED, AN INDIAN COMPANY HAVING ITS REGISTERED OFFICE AT □EMAMI TOWER□, 687 ANANDAPUR, EM BYPASS, KOLKATA 700017, WEST BENGAL, INDIA			
DATE OF REGISTRATION	19/08/2013		
TITLE	LID OF CAP OF A TUBE		
PRIORITY NA			
DESIGN NUMBER	254249		
CLASS	15-99		
1)NICHROME INDIA LIMITED, A COMPANY INCORPORATED UNDER THE INDIAN COMPANIES ACT, SAFIRE PARK, GALLERIA NO. 4, PUNE MUMBAI ROAD, WAKDEWADI, PUNE-411005, MAHARASHTRA, INDIA			
DATE OF REGISTRATION	03/06/2013		
TITLE	PACKAGING MACHINE		
PRIORITY NA			
DESIGN NUMBER	253903		
CLASS	13-03		
1)SIEMENS AKTIENGESELLSCHAFT, OF WITTELSBACHERPLATZ 2, 80333 MUNCHEN, GERMANY, A GERMAN COMPANY			
DATE OF REGISTRATION	16/05/2013		
TITLE	EQUIPMENT FOR THE CONTROL OF ELECTRIC POWER		
PRIORITY			
PRIORITY NUMBER	DATE	COUNTRY	
001352413	26/11/2012	OHIM	

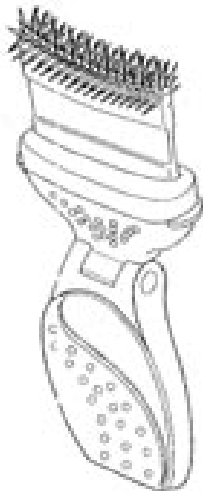

DESIGN NUMBER	255600		
CLASS	02-01		
1)SHREE SIMANDHAR INDUSTRIES IS A PROPRIETORSHIP FIRM OF 21, NEW MANU BHUVAN, BHAGAT SINGH ROAD, VILE PARLE (W) MUMBAI-400056, MAHARASHTRA, INDIA			
DATE OF REGISTRATION	01/08/2013		
TITLE	APRON		
PRIORITY NA			
DESIGN NUMBER	249418		
CLASS	22-01		
1)MAGPUL INDUSTRIES CORPORATION, 400 YOUNG COURT, UNIT 1, ERIE, COLORADO 80516, UNITED STATES OF AMERICA, A COLORADO CORPORATION			
DATE OF REGISTRATION	09/11/2012		
TITLE	RIFLE STOCK		
PRIORITY			
PRIORITY NUMBER	DATE	COUNTRY	
29/423,118	29/05/2012	U.S.A.	
DESIGN NUMBER	255077		
CLASS	15-99		
1)MR. AMAN ASTHANA AND MR. BRAJESH ASTHANA (JOINT OWNER), WHOSE ADDRESS IS D-20, ASHWARYA VILLA, MOTI VIHAR COLONY, RAVATPUR, KANPUR, UP- 208019, INDIAN			
DATE OF REGISTRATION	09/07/2013		
TITLE	POUCH PACKING MACHINE		
PRIORITY NA			

DESIGN NUMBER	255111	
CLASS	12-08	
1)MARUTI SUZUKI INDIA LIMITED, AN INDIAN COMPANY OF 1, NELSON MANDELA ROAD, VASANT KUNJ, NEW DELHI-110070, INDIA		
DATE OF REGISTRATION	10/07/2013	
TITLE	CAR	
PRIORITY NA		

DESIGN NUMBER	253355	
CLASS	28-02	
1)AVON PRODUCTS, INC. 777 THIRD AVENUE NEW YORK, NY 10017 UNITED STATES OF AMERICA		
DATE OF REGISTRATION	23/04/2013	
TITLE	COSMETIC AND PERSONAL CARE APPLICATOR	
PRIORITY		
PRIORITY NUMBER	DATE	COUNTRY
29/435,321	23/10/2012	U.S.A.

DESIGN NUMBER	255289	
CLASS	08-06	
1)(1) KASHYAP A. PATEL (2) SANDIP S. GHONIYA (3) VINAYBHAI M. PATEL (4) PARESH D. RAIYANI ALL INDIAN NATIONAL PARTNERS OF YAKSH SALES CORPORATION AN INDIAN PARTNERSHIP FIRM HAVING ITS PRINCIPAL PLACE OF BUSINESS AT SANSKAR SOCIETY, STREET NO. 1, PLOT NO. 28, NEAR BALAJI INDUSTRIES, AJI RING ROAD, RAJKOT, GUJARAT-INDIA		
DATE OF REGISTRATION	17/07/2013	
TITLE	HANDLE	
PRIORITY NA		

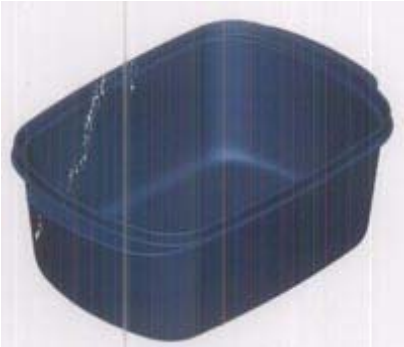
DESIGN NUMBER	255333	
CLASS	07-06	
1)MA DESIGN INDIA PRIVATE LIMITED, A COMPANY INCORPORATED IN INDIA HAVING ITS PRINCIPAL PLACE OF BUSINESS AT A-41, SECTOR-80, PHASE-II, NOIDA-201305, U.P. INDIA		
DATE OF REGISTRATION	18/07/2013	
TITLE	DISH HOLDER	
PRIORITY NA		
DESIGN NUMBER	253569	
CLASS	31-00	
1)HAVELLS INDIA LIMITED HAVING REGISTERED OFFICE AT 1, RAJ NARAIN MARG, CIVIL LINES, DELHI-110054.		
DATE OF REGISTRATION	30/04/2013	
TITLE	MOTOR UNIT FOR MIXER GRINDER	
PRIORITY NA		
DESIGN NUMBER	255809	
CLASS	07-02	
1)MRS. SIMPLE (PROPRIETOR), NATIONALITY INDIAN TRADING AS TULIP INDUSTRIES (THIS IS A PROPRIETORSHIP FIRM) WHOES ADDRESS IS C-130, SECTOR-3, BAWANA INDUSTRIAL AREA, DELHI-110039 (INDIA)		
DATE OF REGISTRATION	14/08/2013	
TITLE	CASSEROLE	
PRIORITY NA		

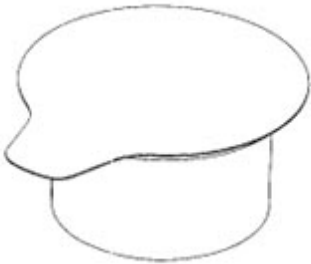

DESIGN NUMBER	251128		
CLASS	07-02		
1)DART INDUSTRIES INC., A CORPORATION FOUNDED UNDER THE LAWS OF DELAWARE, U.S.A. OF 14901 SOUTH ORANGE BLOSSOM TRAIL, ORLANDO, FLORIDA 32837, USA			
DATE OF REGISTRATION	23/01/2013		
TITLE	CONTAINER FOR FOOD		
PRIORITY			
PRIORITY NUMBER	DATE	COUNTRY	
29/421,561	16/08/2012	U.S.A.	
DESIGN NUMBER	251142		
CLASS	07-02		
1)DART INDUSTRIES INC., A CORPORATION FOUNDED UNDER THE LAWS OF DELAWARE, U.S.A. OF 14901 SOUTH ORANGE BLOSSOM TRAIL, ORLANDO, FLORIDA 32837, USA			
DATE OF REGISTRATION	23/01/2013		
TITLE	CONTAINER FOR FOOD		
PRIORITY			
PRIORITY NUMBER	DATE	COUNTRY	
29/421,570	16/08/2012	U.S.A.	
DESIGN NUMBER	253691		
CLASS	24-02		
1)POLY MEDICURE LIMITED, AN INDIAN COMPANY, OF PLOT NO. 105, SECTOR 59, HSIIDC INDUSTRIAL AREA, FARIDABAD, HARYANA-121004, INDIA			
DATE OF REGISTRATION	06/05/2013		
TITLE	FISTULA NEEDLE SET		
PRIORITY NA			

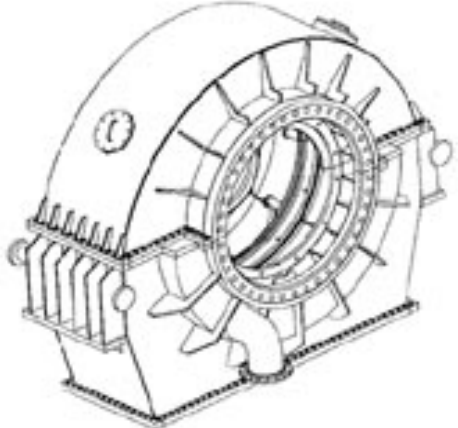

DESIGN NUMBER	255884		
CLASS	09-07		
1)EMAMI LIMITED, AN INDIAN COMPANY HAVING ITS REGISTERED OFFICE AT □EMAMI TOWER□, 687 ANANDAPUR, EM BYPASS, KOLKATA 700 017, WEST BENGAL, INDIA.			
DATE OF REGISTRATION	19/08/2013		
TITLE	CAP OF A TUBE		
PRIORITY NA			
DESIGN NUMBER	250549		
CLASS	23-03		
1)M/S V-GUARD INDUSTRIES LTD., AN INDIAN COMPANY INCORPORATED UNDER THE COMPANIES ACT OF 1956 WHOSE ADDRESS IS 33/2905 F, VENNALA HIGH SCHOOL ROAD, VENNALA, KOCHI-682028, KERALA STATE, INDIA			
DATE OF REGISTRATION	31/12/2012		
TITLE	WATER HEATER		
PRIORITY NA			
DESIGN NUMBER	254170		
CLASS	03-01		
1)SANTEN PHARMACEUTICAL CO., LTD., A JAPANESE COMPANY OF 9-19, SHIMOSHINJO 3-CHOME, HIGASHIYODOGAWA-KU, OSAKA-SHI, OSAKA 5338651, JAPAN			
DATE OF REGISTRATION	29/05/2013		
TITLE	CONTAINER FOR INTRAOCULAR LENS		
PRIORITY			
PRIORITY NUMBER	DATE	COUNTRY	
29/438,505	30/11/2012	U.S.A.	

DESIGN NUMBER	251596	
CLASS	31-00	
1)FIRST ENERGY PVT. LTD., AN INDIAN COMPANY OF B-101 TO B-105, FIRST FLOOR, B-WING, SIGNET CORNER, S.NO-134, BANER, PUNE-411045, INDIA		
DATE OF REGISTRATION	12/02/2013	
TITLE	BIOMASS STOVE	
PRIORITY NA		

DESIGN NUMBER	255403	
CLASS	08-06	
1)DIPAKBHAI BHIKHABHAI KHUNT (ADULT & INDIAN NATIONAL) SOLE PROPRIETOR OF OM SAI MANUFACTURE (INDIAN PROPRIETORSHIP CONCERN) HAVING PLACE OF BUSINESS AT- 6/A, PARSANA SOCIETY, 50, FEET ROAD, SHREENATHJI PAN, RAJKOT-360 002-GUJARAT-(INDIA)		
DATE OF REGISTRATION	26/07/2013	
TITLE	HANDLE	
PRIORITY NA		

DESIGN NUMBER	254989	
CLASS	15-01	
1)TRIVENI TURBINE LIMITED, AN INDIAN COMPANY HAVING ITS PLACE OF BUSINESS AT 12A, PEENYA INDUSTRIAL AREA, BANGLORE-560058		
DATE OF REGISTRATION	04/07/2013	
TITLE	EXHAUST CASING OF A STEAM TURBINE	
PRIORITY NA		

DESIGN NUMBER	255110		
CLASS	12-16		
1)MARUTI SUZUKI INDIA LIMITED, AN INDIAN COMPANY OF 1, NELSON MANDELA ROAD, VASANT KUNJ, NEW DELHI-110070, INDIA			
DATE OF REGISTRATION	10/07/2013		
TITLE	UPPER FRONT GRILL OF A VEHICLE		
PRIORITY NA			
DESIGN NUMBER	253353		
CLASS	28-02		
1)AVON PRODUCTS, INC. 777 THIRD AVENUE NEW YORK, NY 10017 UNITED STATES OF AMERICA			
DATE OF REGISTRATION	23/04/2013		
TITLE	LOWER UNIT OF COSMETIC AND PERSONAL CARE APPLICATOR		
PRIORITY			
PRIORITY NUMBER	DATE	COUNTRY	
29/435,321	23/10/2012	U.S.A.	
DESIGN NUMBER	255207		
CLASS	31-00		
1)BAJAJ ELECTRICALS LIMITED, A COMPANY REGISTERED IN INDIA, HAVING ITS REGISTERED OFFICE AT, 45/47, VEER NARIMAN ROAD, MUMBAI 400023, STATE OF MAHARASHTRA, INDIA, OF ABOVE ADDRESS			
DATE OF REGISTRATION	12/07/2013		
TITLE	JUICER MIXER GRINDER		
PRIORITY NA			



DESIGN NUMBER	255326	
CLASS	07-06	
1)MA DESIGN INDIA PRIVATE LIMITED, A COMPANY INCORPORATED IN INDIA HAVING ITS PRINCIPAL PLACE OF BUSINESS AT A-41, SECTOR-80, PHASE-II, NOIDA-201305, U.P. INDIA		
DATE OF REGISTRATION	18/07/2013	
TITLE	CASSEROLE HOLDER	
PRIORITY NA		
DESIGN NUMBER	253405	
CLASS	09-03	
1)M/S. PENSOL INDUSTRIES LIMITED, AN INDIAN COMPANY, OF 39, J. J. ROAD, RANCHI-834001, JHARKHAND, INDIA		
DATE OF REGISTRATION	25/04/2013	
TITLE	CONTAINER	
PRIORITY NA		
DESIGN NUMBER	253577	
CLASS	24-01	
1)ALLERGAN, INC., 2525 DUPONT DRIVE, IRVINE, CALIFORNIA 92612, U.S.A.		
DATE OF REGISTRATION	30/04/2013	
TITLE	UNIT DOSE VIAL	
PRIORITY NA		

DESIGN NUMBER	254307	
CLASS	12-16	
1)RENAULT TRUCKS, A COMPANY ORGANIZED UNDER THE LAWS OF FRANCE, OF 99 ROUTE DE LYON, 69800 SAINT PRIEST, FRANCE		
DATE OF REGISTRATION	06/06/2013	
TITLE	FRAME COMPONENT FOR VEHICLE HEADLIGHT	
PRIORITY NA		
DESIGN NUMBER	254315	
CLASS	12-16	
1)RENAULT TRUCKS, A COMPANY ORGANIZED UNDER THE LAWS OF FRANCE, OF 99 ROUTE DE LYON, 69800 SAINT PRIEST, FRANCE		
DATE OF REGISTRATION	06/06/2013	
TITLE	REARVIEW MIRROR	
PRIORITY NA		
DESIGN NUMBER	254347	
CLASS	12-08	
1)RENAULT TRUCKS, A COMPANY ORGANIZED UNDER THE LAWS OF FRANCE, OF 99 ROUTE DE LYON, 69800 SAINT PRIEST, FRANCE		
DATE OF REGISTRATION	06/06/2013	
TITLE	TRUCK	
PRIORITY NA		

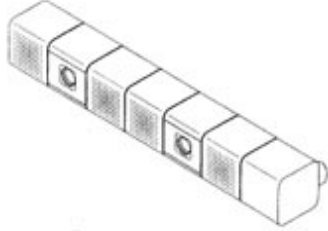

DESIGN NUMBER	252699	
CLASS	01-01	
1)PARLE PRODUCTS PVT. LTD., A COMPANY INCORPORATED UNDER THE INDIAN COMPANIES ACT, AT NORTH LEVEL CROSSING, VILE PARLE (E), MUMBAI-400 057, MAHARASHTRA, INDIA.		
DATE OF REGISTRATION	28/03/2013	
TITLE	BISCUIT	
PRIORITY NA		

DESIGN NUMBER	255632	
CLASS	09-01	
1)SANJAY DHANRAJ PAREKH OF 22/A, TODI ESTATE, SUN MILL COMPOUND, LOWER PAREL (WEST), MUMBAI-400013 MAHARASHTRA, INDIA, INDIAN NATIONAL		
DATE OF REGISTRATION	02/08/2013	
TITLE	BOTTLE	
PRIORITY NA		

DESIGN NUMBER	251133	
CLASS	07-02	
1)DART INDUSTRIES INC., A CORPORATION FOUNDED UNDER THE LAWS OF DELAWARE, U.S.A. OF 14901 SOUTH ORANGE BLOSSOM TRAIL, ORLANDO, FLORIDA 32837, USA		
DATE OF REGISTRATION	23/01/2013	
TITLE	CONTAINER FOR FOOD	
PRIORITY		
PRIORITY NUMBER	DATE	COUNTRY
29/421,569	16/08/2012	U.S.A.

DESIGN NUMBER	253655		
CLASS	16-01		
1)SONY COMPUTER ENTERTAINMENT INC., A JAPANESE COMPANY OF 1-7-1 KONAN, MINATO-KU, TOKYO, JAPAN			
DATE OF REGISTRATION	03/05/2013		
TITLE	CAMERA		
PRIORITY			
PRIORITY NUMBER	DATE	COUNTRY	
2012-027072	06/11/2012	JAPAN	
DESIGN NUMBER	253693		
CLASS	09-01		
1)MR. GHISULAL RATHOD, MR. PRADEEP RATHOD, MR. PANKAJ RATHOD, MR. PANNALAL SHARMA, MR. JAYANTILAL JAIN, MR. GAURAV RATHOD, MRS. SANGEETA RATHOD, MRS. BABITA RATHOD AND MRS. PAMPUBEN RATHOD, ALL INDIAN NATIONALS TRADING UNDER THE NAME AND STYLE OF M/S. CELLO INDUSTRIES, A PARTNERSHIP FIRM REGISTERED UNDER THE PROVISION OF INDIAN PARTNERSHIP ACT, 1932, HAVING OFFICE ADDRESS AT			
CORPORATE AVENUE, 'B' WING, CELLO HOUSE, SONAWALA ROAD, GOREGAON (EAST), MUMBAI-400063, MAHARASHTRA, INDIA			
DATE OF REGISTRATION	06/05/2013		
TITLE	FLASK		
PRIORITY NA			
DESIGN NUMBER	253720		
CLASS	09-01		
1)NAYASA WORLD OF SURVEY NO. 655/1C NEAR SOMNANATH CO.OP.SOCIETY, DABHEL NANI DAMAN, DAMAN-396310, (UNION TERRITORIES) DAMAN, INDIA,			
INDIAN PARTNERSHIP FIRM, WHOSE PARTNERS ARE RUPA SACHDEV, MANASI SACHDEV & KISHOR MALIK, ALL INDIAN NATIONALS			
DATE OF REGISTRATION	08/05/2013		
TITLE	BOTTLE		
PRIORITY NA			

DESIGN NUMBER	254151		
CLASS	23-04		
1)BALDEV KUMAR B. VARMA, A BRITISH NATIONAL, HAVING PERMANENT RESIDENCE AT 19, MIDDLE LANE, DISCOVERY BAY MIDVALE VILLAGE, MARINE VIEW, 18/F FLAT B & PENTHOUSE B, LANTAU ISLAND NT, HONG KONG (ALSO AT A1/701, PARSAVNATH EXOTICA APARTMENTS, GOLF COURSE ROAD, GURGAON, HARYANA)			
DATE OF REGISTRATION	29/05/2013		
TITLE	AIR COOLER		
PRIORITY NA			
DESIGN NUMBER	250023		
CLASS	13-02		
1)SOCIETE BIC, A FRENCH COMPANY, OF 14 RUE JEANNE D'ASNIÈRES, 92110 CLICHY, FRANCE			
DATE OF REGISTRATION	07/12/2012		
TITLE	MOBILE POWER SOURCE		
PRIORITY			
PRIORITY NUMBER	DATE	COUNTRY	
29/424,551	13/06/2012	U.S.A.	
DESIGN NUMBER	253912		
CLASS	09-01		
1)RADICO KHAITAN LIMITED, AN INDIAN COMPANY OF PLOT NO. J-1, BLOCK B-1, MOHAN CO-OP INDUSTRIAL AREA, MATHURA ROAD, NEW DELHI 110044, INDIA			
DATE OF REGISTRATION	17/05/2013		
TITLE	BOTTLE		
PRIORITY NA			

DESIGN NUMBER	255449	
CLASS	09-01	
1)M/S. HIMALAYAN CAPSCON INDUSTRIES HAVING PLACE OF BUSINESS AT 323 M.I. CENTRAL HOPE TOWN, SELAQUI, DEHRADUN-248197 (UTTARAKHAND) INDIA; HAVING THE NATIONALITY OF INDIA		
DATE OF REGISTRATION	23/07/2013	
TITLE	BOTTLE	
PRIORITY NA		
DESIGN NUMBER	255601	
CLASS	02-01	
1)SHREE SIMANDHAR INDUSTRIES IS A PROPRIETORSHIP FIRM OF 21, NEW MANU BHUVAN, BHAGAT SINGH ROAD, VILE PARLE (W) MUMBAI-400056, MAHARASHTRA, INDIA		
DATE OF REGISTRATION	01/08/2013	
TITLE	APRON	
PRIORITY NA		
DESIGN NUMBER	255078	
CLASS	15-01	
1)TRIVENI TURBINE LIMITED, AN INDIAN COMPANY HAVING ITS PLACE OF BUSINESS AT 12A, PEENYA INDUSTRIAL AREA, BANGLORE-560058		
DATE OF REGISTRATION	09/07/2013	
TITLE	ROTOR OF A STEAM TURBINE	
PRIORITY NA		

DESIGN NUMBER	255112
CLASS	12-16
1)MARUTI SUZUKI INDIA LIMITED, AN INDIAN COMPANY OF 1, NELSON MANDELA ROAD, VASANT KUNJ, NEW DELHI-110070, INDIA	
DATE OF REGISTRATION	10/07/2013
TITLE	FRONT BUMPER OF A VEHICLE
PRIORITY NA	

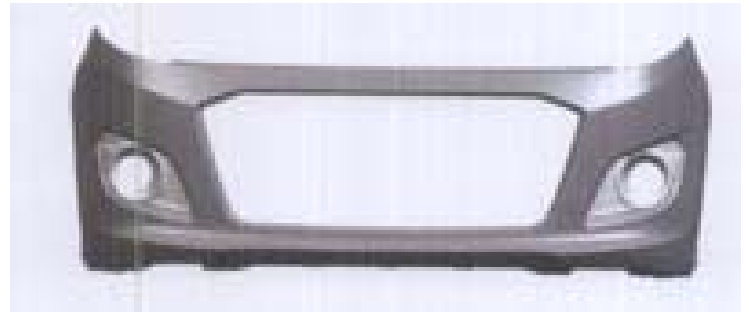

DESIGN NUMBER	251348	
CLASS	13-03	
1)SSB WIND SYSTEMS GMBH & CO. KG, OF NEUENKIRCHENER STRASSE 13, 48499 SALZBERGEN, GERMANY, A GERMAN COMPANY		
DATE OF REGISTRATION	31/01/2013	
TITLE	SWITCHGEAR CABINET	
PRIORITY		
PRIORITY NUMBER	DATE	COUNTRY
40 2012 003 658.7	09/08/2012	GERMANY

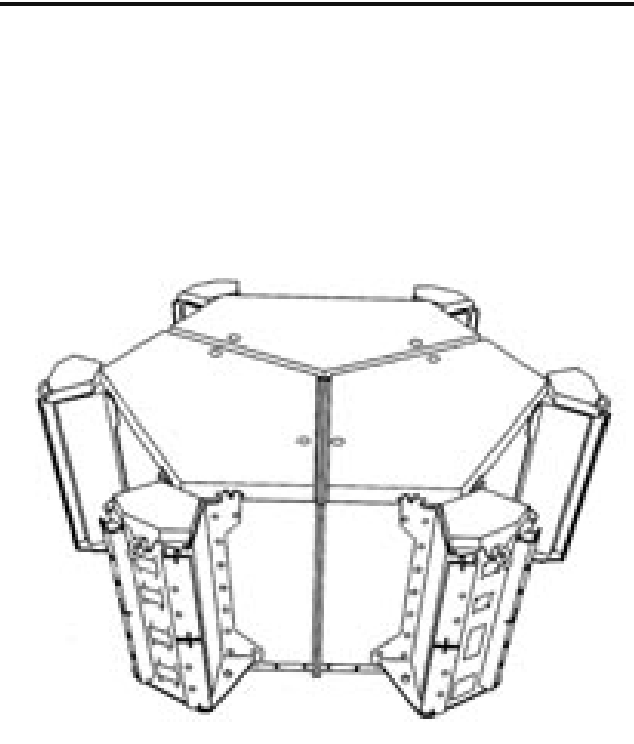

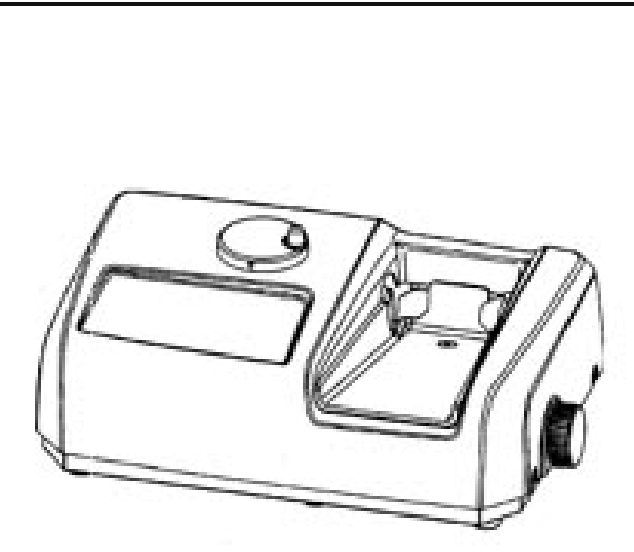

DESIGN NUMBER	253208	
CLASS	24-99	
1)FURUNO ELECTRIC CO., LTD. OF THE ADDRESS: 9-52, ASHIHARA-CHO, NISHINOMIYA-CITY, HYOGO-PREF., 662-8580, JAPAN		
DATE OF REGISTRATION	17/04/2013	
TITLE	BONE DENSITOMETER	
PRIORITY		
PRIORITY NUMBER	DATE	COUNTRY
201230557200.9	16/11/2012	CHINA



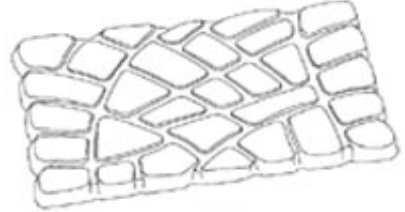

DESIGN NUMBER	253278	
CLASS	09-03	
1)M/S. KRISH CLOTHING COMPANY, A REGISTERED PARTNERSHIP FIRM, REPRESENTED BY ITS PARTNER VIKAS BHANSALI, INDIAN NATIONAL, CARRYING ON THEIR BUSINESS AT OLD NO. 18, RAJA ANNAMALAI ROAD, FIRST FLOOR, CHENNAI-600084 INDIA		
DATE OF REGISTRATION	22/04/2013	
TITLE	PACKING BOX	
PRIORITY NA		
DESIGN NUMBER	255293	
CLASS	26-05	
1)KISH HANDICRAFTS PRIVATE LIMITED, AN INDIAN COMPANY, OF D-174, SECTOR 63, NOIDA, U. P.-201301, INDIA		
DATE OF REGISTRATION	17/07/2013	
TITLE	LAMP STAND	
PRIORITY NA		
DESIGN NUMBER	255327	
CLASS	07-06	
1)MA DESIGN INDIA PRIVATE LIMITED, A COMPANY INCORPORATED IN INDIA HAVING ITS PRINCIPAL PLACE OF BUSINESS AT A-41, SECTOR-80, PHASE-II, NOIDA-201305, U.P. INDIA		
DATE OF REGISTRATION	18/07/2013	
TITLE	DISH HOLDER	
PRIORITY NA		



DESIGN NUMBER	253596	
CLASS	10-05	
1)PATEL MUKESHKUMAR AMRUTLAL, AN INDIAN NATIONAL, RESIDING AT PLOT NO.: 310/2, MANGALMURTI PARK, SECTOR-8, GANDHINAGAR, PIN CODE: 382007, GUJARAT, INDIA		
DATE OF REGISTRATION	01/05/2013	
TITLE	SOIL ANALYZER	
PRIORITY NA		
DESIGN NUMBER	254297	
CLASS	12-16	
1)RENAULT TRUCKS, A COMPANY ORGANIZED UNDER THE LAWS OF FRANCE, OF 99 ROUTE DE LYON, 69800 SAINT PRIEST, FRANCE		
DATE OF REGISTRATION	06/06/2013	
TITLE	REARVIEW MIRROR	
PRIORITY NA		
DESIGN NUMBER	254348	
CLASS	12-08	
1)RENAULT TRUCKS, A COMPANY ORGANIZED UNDER THE LAWS OF FRANCE, OF 99 ROUTE DE LYON, 69800 SAINT PRIEST, FRANCE		
DATE OF REGISTRATION	06/06/2013	
TITLE	TRUCK	
PRIORITY NA		



DESIGN NUMBER	255821		
CLASS	21-02		
1)MIRIK RAJENDRA GOGRI, INDIAN NATIONAL, 1401, ANTRIKSH TOWER, MURAR ROAD, MULUND (W), MUMBAI-400 080, MAHARASHTRA, INDIA.			
DATE OF REGISTRATION	14/08/2013		
TITLE	BAT		
PRIORITY NA			
DESIGN NUMBER	253667		
CLASS	01-01		
1)KRAFT FOODS UK R&D LIMITED, PO BOX 12, BOURNVILLE LANE, BOURNVILLE, BIRMINGHAM, WEST MIDLANDS B30 2LU, UNITED KINGDOM, NATIONALITY: U.K.			
DATE OF REGISTRATION	03/05/2013		
TITLE	CHOCOLATE BAR		
PRIORITY			
PRIORITY NUMBER	DATE	COUNTRY	
002130641-0002	05/11/2012	OHIM	
DESIGN NUMBER	253829		
CLASS	06-08		
1)MAINETTI (UK) LIMITED, A COMPANY INCORPORATED IN SCOTLAND OF ANNFIELD ESTATE, OXNAM ROAD, JEDBURGH, ROXBURGHSHIRE, SCOTLAND, TD8 6NN, UNITED KINGDOM			
DATE OF REGISTRATION	14/05/2013		
TITLE	SIZE MARKER OF A GARMENT HANGER		
PRIORITY			
PRIORITY NUMBER	DATE	COUNTRY	
4027484	15/11/2012	U.K.	

DESIGN NUMBER	255999	
CLASS	11-01	
1)R. R. JEWELLERS IS A PARTNERSHIP FIRM REGISTERED UNDER THE PARTNERSHIP ACT, 1932 BETWEEN 1) JIGNESH RAMESHBHAI SHAH 2) TEJAS RAMESHBHAI SHAH AND 3) ALPA JIGNESHBHAI SHAH WHOSE OFFICE IS AT 3RD FLOOR, "PANNA MANEK", OPP. MAA ASHAPURA TEMPLE, PALACE ROAD, RAJKOT-360001, GUJARAT, INDIA		
DATE OF REGISTRATION	23/08/2013	
TITLE	EARRING	
PRIORITY NA		

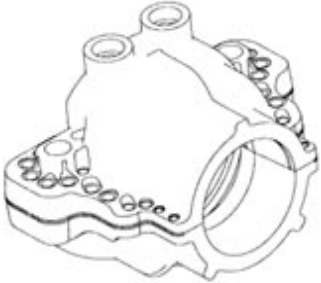
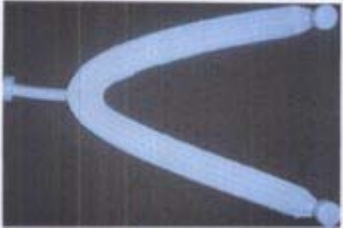
DESIGN NUMBER	254152	
CLASS	23-04	
1)BALDEV KUMAR B. VARMA, A BRITISH NATIONAL, HAVING PERMANENT RESIDENCE AT 19, MIDDLE LANE, DISCOVERY BAY MIDVALE VILLAGE, MARINE VIEW, 18/F FLAT B & PENTHOUSE B, LANTAU ISLAND NT, HONG KONG (ALSO AT A1/701, PARSAVNATH EXOTICA APARTMENTS, GOLF COURSE ROAD, GURGAON, HARYANA)		
DATE OF REGISTRATION	29/05/2013	
TITLE	AIR COOLER	
PRIORITY NA		

DESIGN NUMBER	251611	
CLASS	06-04	
1)RABIRUN VINIMAY PVT. LTD., PLOT F3, SECTOR F, VIDYASAGAR INDUSTRIAL PARK, (KHARAGPUR-WBIDC), VILL./MOUZA-JAPHALA, P.O.-JAKPUR, P.S.-KHARAGPUR (L), DIST.-PASCHIM MEDINIPUR-721301, WEST BENGAL, INDIA		
DATE OF REGISTRATION	13/02/2013	
TITLE	KITCHEN CABINETS	
PRIORITY NA		

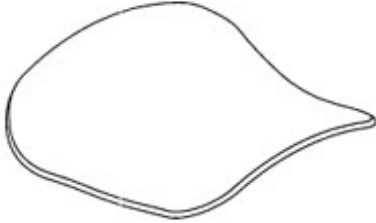
DESIGN NUMBER	255391	
CLASS	15-01	
1)TRIVENI TURBINE LIMITED, AN INDIAN COMPANY HAVING ITS PLACE OF BUSINESS AT 12A, PEENYA INDUSTRIAL AREA, BANGLORE-560058		
DATE OF REGISTRATION	22/07/2013	
TITLE	INNER CASING OF A STEAM TURBINE	
PRIORITY NA		
DESIGN NUMBER	255489	
CLASS	02-04	
1)KHADIM INDIA LIMITED, AN INDIAN COMPANY HAVING ITS REGISTERED OFFICE AT KANKARIA ESTATE, 5TH FLOOR, 6, LITTLE RUSSELL STREET KOLKATA 700071, WEST BENGAL, INDIA		
DATE OF REGISTRATION	24/07/2013	
TITLE	STRAP OF FOOTWEAR	
PRIORITY NA		
DESIGN NUMBER	255602	
CLASS	02-01	
1)SHREE SIMANDHAR INDUSTRIES IS A PROPRIETORSHIP FIRM OF 21, NEW MANU BHUVAN, BHAGAT SINGH ROAD, VILE PARLE (W) MUMBAI-400056, MAHARASHTRA, INDIA		
DATE OF REGISTRATION	01/08/2013	
TITLE	APRON	
PRIORITY NA		

DESIGN NUMBER	223922		
CLASS	24-02		
1)DIRECTA AB BOX 723, S-194 27 UPPLANDS VASBY, SWEDEN			
DATE OF REGISTRATION	22/07/2009		
TITLE	DENTAL INSTRUMENT		
PRIORITY			
PRIORITY NUMBER	DATE	COUNTRY	
001076533	27/01/2009	EUROPEAN UNION	
DESIGN NUMBER	254998		
CLASS	24-04		
1)3M INNOVATIVE PROPERTIES COMPANY, A COMPANY INCORPORATED IN THE STATE OF DELAWARE OF 3M CENTER, SAINT PAUL, MINNESOTA 55133-3427, USA			
DATE OF REGISTRATION	04/07/2013		
TITLE	ARCH SUPPORT		
PRIORITY			
PRIORITY NUMBER	DATE	COUNTRY	
29/441,613	08/01/2013	U.S.A.	
DESIGN NUMBER	255113		
CLASS	12-16		
1)MARUTI SUZUKI INDIA LIMITED, AN INDIAN COMPANY OF 1, NELSON MANDELA ROAD, VASANT KUNJ, NEW DELHI-110070, INDIA			
DATE OF REGISTRATION	10/07/2013		
TITLE	REAR BUMPER OF A VEHICLE		
PRIORITY NA			

DESIGN NUMBER	248957		
CLASS	09-02		
1)DART INDUSTRIES INC., A CORPORATION FOUNDED UNDER THE LAWS OF DELAWARE, U.S.A. OF 14901 SOUTH ORANGE BLOSSOM TRAIL, ORLANDO, FLORIDA 32837, USA			
DATE OF REGISTRATION	23/10/2012		
TITLE	STORAGE CONTAINER		
PRIORITY			
PRIORITY NUMBER	DATE	COUNTRY	
29/421,057	11/05/2012	U.S.A.	
DESIGN NUMBER	255296		
CLASS	26-05		
1)KISH HANDICRAFTS PRIVATE LIMITED, AN INDIAN COMPANY, OF D-174, SECTOR 63, NOIDA, U. P.-201301, INDIA			
DATE OF REGISTRATION	17/07/2013		
TITLE	LAMP STAND		
PRIORITY NA			
DESIGN NUMBER	255309		
CLASS	07-06		
1)MA DESIGN INDIA PRIVATE LIMITED, A COMPANY INCORPORATED IN INDIA HAVING ITS PRINCIPAL PLACE OF BUSINESS AT A-41, SECTOR-80, PHASE-II, NOIDA-201305, U.P. INDIA			
DATE OF REGISTRATION	18/07/2013		
TITLE	COASTER (SET)		
PRIORITY NA			

DESIGN NUMBER	255369	
CLASS	07-02	
1)HAMILTON HOUSEWARES PVT. LTD. AN INDIAN COMPANY INCORPORATED UNDER THE COMPANIES ACT 1956, HAVING REGISTERED OFFICE AT KAISER-I-HIND BLDG., 3RD FLOOR, CURRIMBHOY ROAD, BALLARD ESTATE, MUMBAI 400001, MAHARASHTRA, INDIA		
DATE OF REGISTRATION	22/07/2013	
TITLE	CASSEROLE	
PRIORITY NA		

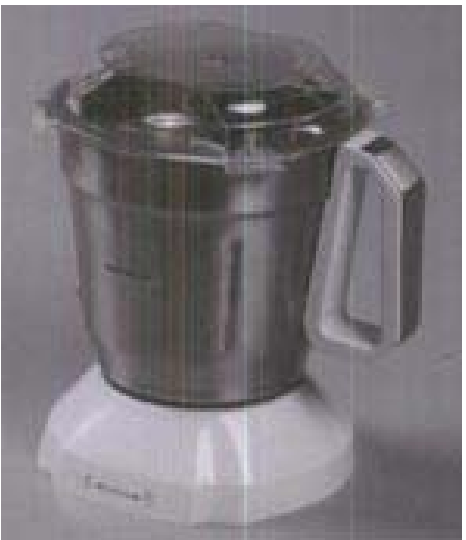
DESIGN NUMBER	253567	
CLASS	31-00	
1)HAVELLS INDIA LIMITED HAVING REGISTERED OFFICE AT 1, RAJ NARAIN MARG, CIVIL LINES, DELHI-110054.		
DATE OF REGISTRATION	30/04/2013	
TITLE	MIXER GRINDER JAR	
PRIORITY NA		

DESIGN NUMBER	254480	
CLASS	02-04	
1)M/S VEEKESY ELASTOMERS PVT LTD, AN INDIAN COMPANY REGISTERED UNDER COMPANIES ACT, 1956, HAVING ITS REGISTERED OFFICE AT DOOR NO. VII/330, NH-17, KOLATHARA P.O, KOZHIKODE, PIN-673655, KERALA, INDIA		
DATE OF REGISTRATION	13/06/2013	
TITLE	FOOTWEAR	
PRIORITY NA		

DESIGN NUMBER	251138	
CLASS	07-02	
1)DART INDUSTRIES INC., A CORPORATION FOUNDED UNDER THE LAWS OF DELAWARE, U.S.A. OF 14901 SOUTH ORANGE BLOSSOM TRAIL, ORLANDO, FLORIDA 32837, USA		
DATE OF REGISTRATION	23/01/2013	
TITLE	CONTAINER FOR FOOD	
PRIORITY		
PRIORITY NUMBER	DATE	COUNTRY
29/421,566	16/08/2012	U.S.A.



DESIGN NUMBER	251191	
CLASS	13-03	
1)EMERSON ELECTRIC CO., A CORPORATION ORGANIZED UNDER THE LAWS OF THE STATE OF MISSOURI, 8000, WEST FLORISSANT, ST. LOUIS, MISSOURI 63136, UNITED STATES OF AMERICA		
DATE OF REGISTRATION	24/01/2013	
TITLE	HERMETIC TERMINAL	
PRIORITY		
PRIORITY NUMBER	DATE	COUNTRY
29/429570	14/08/2012	U.S.A.

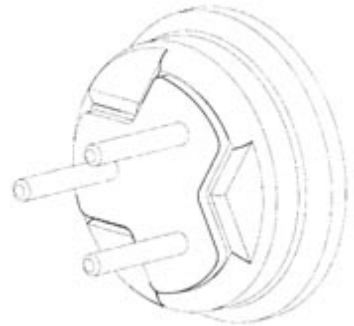

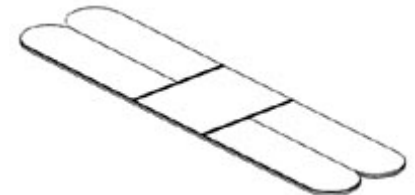

DESIGN NUMBER	253816	
CLASS	24-04	
1)RAY ARBESMAN, OF 42 BURTON ROAD, TORONTO, ONTARIO M5P 1V2, CANADA, NATIONALITY: CANADA		
DATE OF REGISTRATION	14/05/2013	
TITLE	ADHESIVE BRACE FOR BRACING BODY PARTS	
PRIORITY		
PRIORITY NUMBER	DATE	COUNTRY
148526	14/11/2012	CANADA

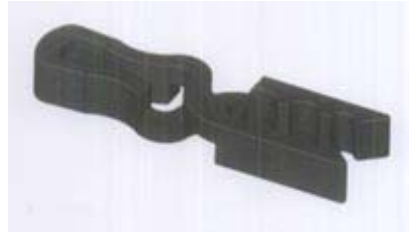
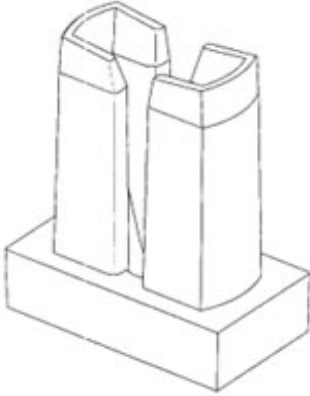
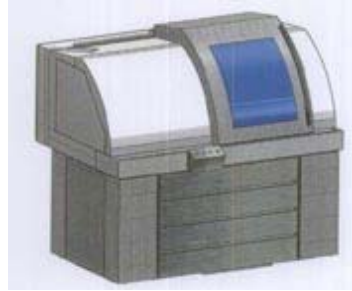

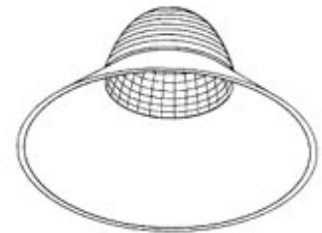

DESIGN NUMBER	254069		
CLASS	07-05		
1)MR. D. KARTHIC RAJ AND MR. G. ARUN HAVING ADDRESS AT NO.22, PILLAYAR KOVIL 5TH STREET, EKKADUTHANGAL, CHENNAI-600 032, TAMIL NADU, INDIA			
DATE OF REGISTRATION	24/05/2013		
TITLE	CLOTH PEG		
PRIORITY NA			
DESIGN NUMBER	254164		
CLASS	03-01		
1)SANTEN PHARMACEUTICAL CO., LTD., OF 9-19, SHIMOSHINJO 3-CHOME, HIGASHIYODOGAWA-KU, OSAKA-SHI, OSAKA 5338651, JAPAN			
DATE OF REGISTRATION	29/05/2013		
TITLE	HOLDER FOR INTRAOCULAR LENS		
PRIORITY			
PRIORITY NUMBER	DATE	COUNTRY	
29/438503	30/11/2012	U.S.A.	
DESIGN NUMBER	251485		
CLASS	15-09		
1)KLAD ON DESIGN PVT LTD, HAVING PLACE OF BUSINESS AT- #5&6, SURVEY NO 38/2, NADAKERAPPA INDUSTRIAL ESTATE, ANDRAHALLI MAIN ROAD, NEAR PEENYA 2ND STAGE, BANGALORE-560091			
DATE OF REGISTRATION	07/02/2013		
TITLE	MACHINE ENCLOSURE FOR PRECISION MACHINE		
PRIORITY NA			

DESIGN NUMBER	253897	
CLASS	09-03	
1)SHRI MAA DISTRIBUTIONS INDIA PVT. LTD., AN INDIAN COMPANY INCORPORATED UNDER THE INDIAN COMPANIES ACT, 1956, HAVING ITS ADDRESS AT 1107, HEMKUNT HOUSE, 6 RAJENDRA PLACE, DELHI-110008, INDIA		
DATE OF REGISTRATION	16/05/2013	
TITLE	PACKAGING	
PRIORITY NA		
DESIGN NUMBER	255108	
CLASS	26-06	
1)MARUTI SUZUKI INDIA LIMITED, AN INDIAN COMPANY OF 1, NELSON MANDELA ROAD, VASANT KUNJ, NEW DELHI-110070, INDIA		
DATE OF REGISTRATION	10/07/2013	
TITLE	REAR LAMP OF A VEHICLE	
PRIORITY NA		
DESIGN NUMBER	255230	
CLASS	26-05	
1)ZUMTOBEL LIGHTING GMBH OF GREVENMARSCHSTRASSE 74-78, 32657 LEMGO GERMANY; NATIONALITY: GERMAN		
DATE OF REGISTRATION	15/07/2013	
TITLE	REFLECTOR FOR LUMINAIRE	
PRIORITY		
PRIORITY NUMBER	DATE	COUNTRY
001 364 624	20/03/2013	OHIM



DESIGN NUMBER	255295	
CLASS	26-05	
1)KISH HANDICRAFTS PRIVATE LIMITED, AN INDIAN COMPANY, OF D-174, SECTOR 63, NOIDA, U. P.-201301, INDIA		
DATE OF REGISTRATION	17/07/2013	
TITLE	LAMP STAND	
PRIORITY NA		



DESIGN NUMBER	255308	
CLASS	26-01	
1)MA DESIGN INDIA PRIVATE LIMITED, A COMPANY INCORPORATED IN INDIA HAVING ITS PRINCIPAL PLACE OF BUSINESS AT A-41, SECTOR-80, PHASE-II, NOIDA-201305, U.P. INDIA		
DATE OF REGISTRATION	18/07/2013	
TITLE	CANDLE HOLDER	
PRIORITY NA		



DESIGN NUMBER	255330	
CLASS	07-06	
1)MA DESIGN INDIA PRIVATE LIMITED, A COMPANY INCORPORATED IN INDIA HAVING ITS PRINCIPAL PLACE OF BUSINESS AT A-41, SECTOR-80, PHASE-II, NOIDA-201305, U.P. INDIA		
DATE OF REGISTRATION	18/07/2013	
TITLE	DISH HOLDER	
PRIORITY NA		

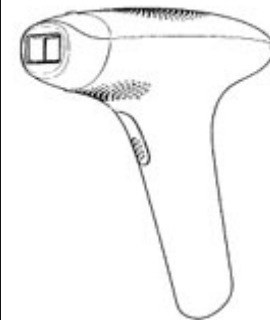

DESIGN NUMBER	253566	
CLASS	31-00	
1)HAVELLS INDIA LIMITED HAVING REGISTERED OFFICE AT 1, RAJ NARAIN MARG, CIVIL LINES, DELHI-110054.		
DATE OF REGISTRATION	30/04/2013	
TITLE	MIXER GRINDER JAR	
PRIORITY NA		
DESIGN NUMBER	254299	
CLASS	12-16	
1)RENAULT TRUCKS, A COMPANY ORGANIZED UNDER THE LAWS OF FRANCE, OF 99 ROUTE DE LYON, 69800 SAINT PRIEST, FRANCE		
DATE OF REGISTRATION	06/06/2013	
TITLE	BUMPER FOR VEHICLE	
PRIORITY NA		
DESIGN NUMBER	255801	
CLASS	07-02	
1)HEMANT M. JAIN, PROPRIETOR- INDIAN NATIONAL, TRADING AS HAPPY HOME PRODUCTS, HAVING ITS REGISTERED OFFICE AT BLDG. NO.2, GALA NO. 14 & 15, PARAM INDUSTRIAL ESTATE, NAIK PADA, VALIV, VASAI (EAST), THANE-401208, STATE OF MAHARASHTRA, INDIA, OF ABOVE ADDRESS		
DATE OF REGISTRATION	13/08/2013	
TITLE	LUNCH BOX	
PRIORITY NA		

DESIGN NUMBER	253670	
CLASS	09-01	
1)MR. GHISULAL RATHOD, MR. PRADEEP RATHOD, MR. PANKAJ RATHOD, MR. PANNALAL SHARMA, MR. JAYANTILAL JAIN, MRS. SANGEETA RATHOD AND MRS. BABITA RATHOD, ALL INDIAN NATIONALS TRADING UNDER THE NAME AND STYLE OF M/S. CELLO PLASTOTECH, A PARTNERSHIP FIRM REGISTERED UNDER THE PROVISION OF INDIAN PARTNERSHIP ACT, 1932, HAVING OFFICE ADDRESS AT 5 CORPORATE AVENUE, 'B' WING, CELLO HOUSE, SONAWALA ROAD, GOREGAON (EAST), MUMBAI-400063, MAHARASHTRA, INDIA		
DATE OF REGISTRATION	03/05/2013	
TITLE	BOTTLE	
PRIORITY NA		
DESIGN NUMBER	253764	
CLASS	14-03	
1)VIDEOCON INDUSTRIES LIMITED. A COMPANY INCORPORATED UNDER THE INDIAN COMPANIES ACT, AT 14 KMS. STONE, AURANGABAD-PAITHAN ROAD, CHITEGAON, TQ.PAITHAN, DIST. AURANGABAD-431105, MAHARASHTRA, INDIA		
DATE OF REGISTRATION	10/05/2013	
TITLE	TELEVISION	
PRIORITY NA		
DESIGN NUMBER	254068	
CLASS	28-03	
1)KONINKLIJKE PHILIPS N.V., A COMPANY ORGANIZED AND EXISTING UNDER THE LAWS OF THE KINGDOM OF THE NETHERLANDS, RESIDING AT EINDHOVEN, WHOSE POST-OFFICE ADDRESS IS HIGH TECH CAMPUS 5, 5656 AE EINDHOVEN, THE NETHERLANDS		
DATE OF REGISTRATION	24/05/2013	
TITLE	FLASH LAMP EPILATOR	
PRIORITY		
PRIORITY NUMBER	DATE	COUNTRY
002142737-0001	27/11/2012	OHIM



DESIGN NUMBER	254155	
CLASS	07-02	
1)SHILPA VIJAYBHAI VANPARIYA, INDIAN NATIONAL, HAVING ITS PLACE OF BUSINESS AT “VENKATESHWAR INDUSTRIES□, UPTO GONDAL ROAD OCTROI NAKA, B/H. ROLEX BEARING, KOTHARIYA SURVEY NO. 150, RAJKOT-360004 (GUJARAT) (INDIA)		
DATE OF REGISTRATION	29/05/2013	
TITLE	HANDLE OF COOKING UTENSIL	
PRIORITY NA		
DESIGN NUMBER	255056	
CLASS	26-05	
1)THRIVE SOLAR ENERGY PVT. LTD., (INCORPORATED UNDER THE COMPANIES ACT, 1956) HAVING OFFICE AT PLOT NO. 121/3, EASTERN PART, PHASE II, SECTOR-I, LANE-9, IDA CHERLAPALLY, HYDERABAD-500051 (A.P.), INDIA, INDIAN COMPANY AT THE ABOVE ADDRESS		
DATE OF REGISTRATION	08/07/2013	
TITLE	LAMP	
PRIORITY NA		
DESIGN NUMBER	253337	
CLASS	19-06	
1)ANCHOR ENTERPRISES PVT. LTD INNOVA ‘C WING, MARATHON NEXTGEN, OFF.G.K.MARG, LOWER PAREL (W), MUMBAI-400013 STATE OF MAHARASHTRA INDIA, / A PRIVATE LIMITED COMPANY INCORPORATED UNDER INDIAN COMPANIES ACT., ABOVE ADDRESS		
DATE OF REGISTRATION	23/04/2013	
TITLE	BALL POINT PEN	
PRIORITY NA		

DESIGN NUMBER	254789	
CLASS	08-06	
1)ITALIK METALWARE PVT. LTD., G: 212-215, LODHIKA, G.I.D.C., KALAWAD ROAD, METODA, RAJKOT-360003, STATE OF GUJARAT INDIA, / A PRIVATE LIMITED COMPANY INCORPORATED UNDER INDIAN COMPANIES ACT., ABOVE ADDRESS		
DATE OF REGISTRATION	25/06/2013	
TITLE	HANDLE	
PRIORITY NA		
DESIGN NUMBER	255294	
CLASS	26-05	
1)KISH HANDICRAFTS PRIVATE LIMITED, AN INDIAN COMPANY, OF D-174, SECTOR 63, NOIDA, U. P.-201301, INDIA		
DATE OF REGISTRATION	17/07/2013	
TITLE	LAMP STAND	
PRIORITY NA		
DESIGN NUMBER	255307	
CLASS	07-01	
1)MA DESIGN INDIA PRIVATE LIMITED, A COMPANY INCORPORATED IN INDIA HAVING ITS PRINCIPAL PLACE OF BUSINESS AT A-41, SECTOR-80, PHASE-II, NOIDA-201305, U.P. INDIA		
DATE OF REGISTRATION	18/07/2013	
TITLE	CHEESEBOARD	
PRIORITY NA		

DESIGN NUMBER	253506		
CLASS	01-01		
1)KRAFT FOODS UK R&D LIMITED, PO BOX 12, BOURNVILLE LANE, BOURNVILLE, BIRMINGHAM, WEST MIDLANDS B30 2LU, UNITED KINGDOM, NATIONALITY: U.K.			
DATE OF REGISTRATION	29/04/2013		
TITLE	CHOCOLATE BAR		
PRIORITY			
PRIORITY NUMBER	DATE	COUNTRY	
002130641-0001	05/11/2012	OHIM	
DESIGN NUMBER	250275		
CLASS	23-04		
1)KHAITAN (INDIA) LIMITED, AN INDIAN COMPANY HAVING ITS REGISTERED OFFICE AT 46C, JAWAHAR LAL NEHRU ROAD, KOLKATA 700071, WEST BENGAL, INDIA.			
DATE OF REGISTRATION	18/12/2012		
TITLE	AIR COOLER		
PRIORITY NA			
DESIGN NUMBER	255743		
CLASS	06-01		
1)THE SUPREME INDUSTRIES LTD., (AN INDIAN PUBLIC LIMITED COMPANY), 601 CENTRAL PLAZA, 2/6, SARAT BOSE ROAD, KOLKATA - 700020, WEST BENGAL, INDIA			
DATE OF REGISTRATION	12/08/2013		
TITLE	CHAIR		
PRIORITY NA			



DESIGN NUMBER	253624		
CLASS	23-03		
1)MR. DHITI TOWIWAT A CITIZEN OF THAILAND OF THE ADDRESS: 163/71, PHAHONYOTHIN 32, KHWAENG LAT YAO, KHET CHATUCHAK, BANGKOK, THAILAND			
DATE OF REGISTRATION	02/05/2013		
TITLE	HEAT EXCHANGER		
PRIORITY			
PRIORITY NUMBER	DATE	COUNTRY	
1202002951	08/11/2012	THAILAND	
DESIGN NUMBER	253669		
CLASS	09-01		
1)MR. GHISULAL RATHOD, MR. PRADEEP RATHOD, MR. PANKAJ RATHOD, MR. PANNALAL SHARMA, MR. JAYANTILAL JAIN, MRS. SANGEETA RATHOD AND MRS. BABITA RATHOD, ALL INDIAN NATIONALS TRADING UNDER THE NAME AND STYLE OF M/S. CELLO PLASTOTECH, A PARTNERSHIP FIRM REGISTERED UNDER THE PROVISION OF INDIAN PARTNERSHIP ACT, 1932, HAVING OFFICE ADDRESS AT 5 CORPORATE AVENUE, 'B' WING, CELLO HOUSE, SONAWALA ROAD, GOREGAON (EAST), MUMBAI-400063, MAHARASHTRA, INDIA			
DATE OF REGISTRATION	03/05/2013		
TITLE	BOTTLE		
PRIORITY NA			
DESIGN NUMBER	253677		
CLASS	09-01		
1)DABUR INDIA LIMITED CORPORATE OFFICE KAUSHAMBI, SAHIBABAD-201010, DISTT. GHAZIABAD (U.P.) INDIA, AN INDIAN COMPANY			
DATE OF REGISTRATION	06/05/2013		
TITLE	BOTTLE		
PRIORITY NA			



DESIGN NUMBER	253731		
CLASS	24-02		
1)KARL STORZ GMBH & CO. KG, A GERMAN COMPANY OF MITTELSTRASSE 8, D-78532 TUTTLINGEN, GERMANY			
DATE OF REGISTRATION	06/05/2013		
TITLE	VIDEO SWITCHER AND DISTRIBUTION AMPLIFIER FOR USE IN MEDICAL ENDOSCOPY		
PRIORITY			
PRIORITY NUMBER	DATE	COUNTRY	
002132084-0010	07/11/2012	OHIM	
DESIGN NUMBER	256095		
CLASS	12-11		
1)S. UPINDER SINGH OF HOUSE NO. 186-B, BHAI RANDHIR SINGH NAGAR, LUDHIANA-141002 (PUNJAB), INDIA, INDIAN NATIONAL			
DATE OF REGISTRATION	28/08/2013		
TITLE	BICYCLE CRANK		
PRIORITY NA			
DESIGN NUMBER	254154		
CLASS	23-04		
1)BALDEV SINGH, AN INDIAN CITIZEN, WITH ITS ADDRESS AT B. S. ENTERPRISES, OPP. GOVT. GIRL SCHOOL, CITY: KURALI, PIN CODE: 140103, STATE: PUNJAB INDIA			
DATE OF REGISTRATION	29/05/2013		
TITLE	COOLER		
PRIORITY NA			



DESIGN NUMBER	251613	
CLASS	06-04	
1)RABIRUN VINIMAY PVT. LTD., PLOT F3, SECTOR F, VIDYASAGAR INDUSTRIAL PARK, (KHARAGPUR-WBIDC), VILL./MOUZA-JAPHALA, P.O.-JAKPUR, P.S.-KHARAGPUR (L), DIST.-PASCHIM MEDINIPUR-721301, WEST BENGAL, INDIA		
DATE OF REGISTRATION	13/02/2013	
TITLE	KITCHEN CORNER CABINET	
PRIORITY NA		

DESIGN NUMBER	253011	
CLASS	23-04	
1)RAJ MAHAJAN, H. NO. 4939, MOHAN NAGAR, NEAR POST OFFICE, SULTANWIND RAOD, AMRITSAR (PUNJAB), INDIA, AN INDIAN NATIONAL		
DATE OF REGISTRATION	11/04/2013	
TITLE	STAND FOR PEDESTAL FAN	
PRIORITY NA		

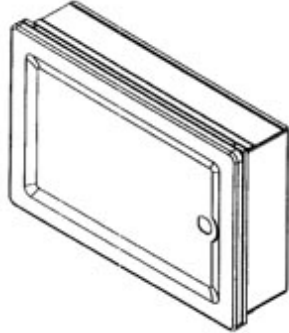
DESIGN NUMBER	255604	
CLASS	07-01	
1)SHREE SIMANDHAR INDUSTRIES IS A PROPRIETORSHIP FIRM OF 21, NEW MANU BHUVAN, BHAGAT SINGH ROAD, VILE PARLE (W) MUMBAI-400056, MAHARASHTRA, INDIA		
DATE OF REGISTRATION	01/08/2013	
TITLE	BOWL	
PRIORITY NA		

DESIGN NUMBER	255043		
CLASS	12-08		
1)BAYERISCHE MOTOREN WERKE AKTIENGESELLSCHAFT, OF PETUELRING 130, 80809, MUNICH, GERMANY, A GERMAN COMPANY			
DATE OF REGISTRATION	05/07/2013		
TITLE	CAR		
PRIORITY			
PRIORITY NUMBER	DATE	COUNTRY	
DE 402013100033.3	10/01/2013	GERMANY	
DESIGN NUMBER	255055		
CLASS	26-05		
1)THRIVE SOLAR ENERGY PVT. LTD., (INCORPORATED UNDER THE COMPANIES ACT, 1956) HAVING OFFICE AT PLOT NO. 121/3, EASTERN PART, PHASE II, SECTOR-I, LANE-9, IDA CHERLAPALLY, HYDERABAD-500051 (A.P.), INDIA, INDIAN COMPANY AT THE ABOVE ADDRESS			
DATE OF REGISTRATION	08/07/2013		
TITLE	LAMP		
PRIORITY NA			
DESIGN NUMBER	251273		
CLASS	23-04		
1)S.C. JOHNSON & SON, INC., A CORPORATION ORGANIZED AND EXISTING UNDER THE LAWS OF THE STATE OF WISCONSIN, UNITED STATES OF AMERICA WHO ARE AMERICAN BY NATIONALITY AND WHOSE ADDRESS IS 1525 HOWE STREET, RACINE, WISCONSIN 53403-2236, UNITED STATES OF AMERICA			
DATE OF REGISTRATION	29/01/2013		
TITLE	REMOVABLE INSERT FOR A DISPENSING DEVICE		
PRIORITY			
PRIORITY NUMBER	DATE	COUNTRY	
29/428,492	31/07/2012	U.S.A.	



DESIGN NUMBER	253231		
CLASS	13-03		
1)SCHNEIDER ELECTRIC INDUSTRIES SAS, A FRENCH COMPANY OF 35, RUE JOSEPH MONIER, F-92500 RUEIL-MALMAISON, FRANCE			
DATE OF REGISTRATION	18/04/2013		
TITLE	ELECTRICAL EQUIPMENT HOUSING		
PRIORITY NA			
DESIGN NUMBER	248958		
CLASS	09-02		
1)DART INDUSTRIES INC., A CORPORATION FOUNDED UNDER THE LAWS OF DELAWARE, U.S.A. OF 14901 SOUTH ORANGE BLOSSOM TRAIL, ORLANDO, FLORIDA 32837, USA			
DATE OF REGISTRATION	23/10/2012		
TITLE	STORAGE CONTAINER		
PRIORITY			
PRIORITY NUMBER	DATE	COUNTRY	
29/421,059	11/05/2012	U.S.A.	
DESIGN NUMBER	255172		
CLASS	26-06		
1)VOLVO TRUCK CORPORATION, OF 405 08 GÖTEBORG, SWEDEN			
DATE OF REGISTRATION	11/07/2013		
TITLE	LIGHTS FOR VEHICLES		
PRIORITY			
PRIORITY NUMBER	DATE	COUNTRY	
002179564-0006	06/02/2013	OHIM	

DESIGN NUMBER	255204		
CLASS	18-02		
1)CMET INC., A CORPORATION ORGANIZED AND EXISTING UNDER THE LAWS OF JAPAN, OF 5-5, SHIN-YOKOHAMA 2-CHOME, KOHOKU-KU, YOKOHAMA-SHI, KANAGAWA 222-0033, JAPAN			
DATE OF REGISTRATION	12/07/2013		
TITLE	STEREOLITHOGRAPHY MACHINE		
PRIORITY			
PRIORITY NUMBER	DATE	COUNTRY	
2013-000504	15/01/2013	JAPAN	
DESIGN NUMBER	255288		
CLASS	08-06		
1)(1) KASHYAP A. PATEL (2) SANDIP S. GHONIYA (3) VINAYBHAI M. PATEL (4) PARESH D. RAIYANI ALL INDIAN NATIONAL PARTNERS OF YAKSH SALES CORPORATION AN INDIAN PARTNERSHIP FIRM HAVING ITS PRINCIPAL PLACE OF BUSINESS AT SANSKAR SOCIETY, STREET NO. 1, PLOT NO. 28, NEAR BALAJI INDUSTRIES, AJI RING ROAD, RAJKOT, GUJARAT-INDIA			
DATE OF REGISTRATION	17/07/2013		
TITLE	HANDLE		
PRIORITY NA			
DESIGN NUMBER	255332		
CLASS	26-01		
1)MA DESIGN INDIA PRIVATE LIMITED, A COMPANY INCORPORATED IN INDIA HAVING ITS PRINCIPAL PLACE OF BUSINESS AT A-41, SECTOR-80, PHASE-II, NOIDA-201305, U.P. INDIA			
DATE OF REGISTRATION	18/07/2013		
TITLE	CANDLE HOLDER		
PRIORITY NA			

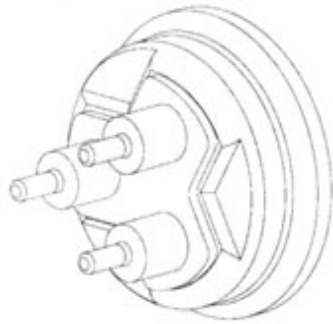

DESIGN NUMBER	253568	
CLASS	31-00	
1)HAVELLS INDIA LIMITED HAVING REGISTERED OFFICE AT 1, RAJ NARAIN MARG, CIVIL LINES, DELHI-110054.		
DATE OF REGISTRATION	30/04/2013	
TITLE	MIXER GRINDER JAR	
PRIORITY NA		

DESIGN NUMBER	254301	
CLASS	12-16	
1)RENAULT TRUCKS, A COMPANY ORGANIZED UNDER THE LAWS OF FRANCE, OF 99 ROUTE DE LYON, 69800 SAINT PRIEST, FRANCE		
DATE OF REGISTRATION	06/06/2013	
TITLE	FRAME COMPONENT FOR VEHICLE HEADLIGHT	
PRIORITY NA		

DESIGN NUMBER	251104	
CLASS	06-11	
1)WILLIAM GOODACRE & SONS INDIA PVT. LTD., A COMPANY DULY REGISTERED UNDER THE COMPANIES ACT, 1956, HAVING ADDRESS AT XVIII/1146 REVI KARUNAKARAN ROAD, ALLEPPEY, KERALA- 688012		
DATE OF REGISTRATION	22/01/2013	
TITLE	FLOOR MAT	
PRIORITY NA		

DESIGN NUMBER	251194		
CLASS	13-03		
1)EMERSON ELECTRIC CO., A CORPORATION ORGANIZED UNDER THE LAWS OF THE STATE OF MISSOURI, 8000, WEST FLORISSANT, ST. LOUIS, MISSOURI 63136, UNITED STATES OF AMERICA			
DATE OF REGISTRATION	24/01/2013		
TITLE	HERMETIC TERMINAL		
PRIORITY			
PRIORITY NUMBER	DATE	COUNTRY	
29/429570	14/08/2012	U.S.A.	
DESIGN NUMBER	253632		
CLASS	15-03		
1)TIRTH AGRO TECHNOLOGY PVT LTD, A COMPANY INCORPORATED UNDER THE INDIAN COMPANIES ACT, HAVING ITS REGISTERED OFFICE AT SHAKTIMAN, SURVEY NO. 108/1, PLOT NO B, AT: BHUNAVA, NEAR GOVARDHAN GINNING, NATIONAL HIGHWAY NO 8B, AFTER BHARUDI TOLL PLAZA, TAL: GONDAL, RAJKOT 360311, GUJARAT, INDIA			
DATE OF REGISTRATION	03/05/2013		
TITLE	SELF PREPELLED PLATFORM FOR AGRICULTURE USE		
PRIORITY NA			
DESIGN NUMBER	253690		
CLASS	24-02		
1)POLY MEDICURE LIMITED, AN INDIAN COMPANY, OF PLOT NO. 105, SECTOR 59, HSIIDC INDUSTRIAL AREA, FARIDABAD, HARYANA-121004, INDIA			
DATE OF REGISTRATION	06/05/2013		
TITLE	FISTULA NEEDLE SET		
PRIORITY NA			

DESIGN NUMBER	253735		
CLASS	02-01		
1)UNICHARM CORPORATION, OF 182, SHIMOBUN, KINSEI-CHO, SHIKOKUCHUO-SHI, EHIME 799-0111, JAPAN; NATIONALITY: JAPAN			
DATE OF REGISTRATION	09/05/2013		
TITLE	DISPOSABLE DIAPER		
PRIORITY			
PRIORITY NUMBER	DATE	COUNTRY	
2012-027501	11/11/2012	JAPAN	
DESIGN NUMBER	250544		
CLASS	23-03		
1)M/S V-GUARD INDUSTRIES LTD., AN INDIAN COMPANY INCORPORATED UNDER THE COMPANIES ACT OF 1956 WHOSE ADDRESS IS 33/2905 F, VENNALA HIGH SCHOOL ROAD, VENNALA, KOCHI-682028, KERALA STATE, INDIA			
DATE OF REGISTRATION	31/12/2012		
TITLE	WATER HEATER		
PRIORITY NA			
DESIGN NUMBER	254129		
CLASS	15-03		
1)NAME: PATEL PRAFULBHAI RAMANBHAI, NATIONALITY: AN INDIAN, ADDRESS: RAMAN FARM, NR. WATER CANAL, N.H.NO. 8, VASAD-388306, GUJARAT, INDIA			
DATE OF REGISTRATION	28/05/2013		
TITLE	MULCHING AND DRIP PIPES LAYING MACHINE		
PRIORITY NA			

DESIGN NUMBER	251489	
CLASS	15-09	
1)KLAD ON DESIGN PVT LTD, HAVING ITS PLACE OF BUSINESS AT- #5&6, SURVEY NO 38/2, NADAKERAPPA INDUSTRIAL ESTATE, ANDRAHALLI MAIN ROAD, NEAR PEENYA 2ND STAGE, BANGALORE-560091		
DATE OF REGISTRATION	07/02/2013	
TITLE	MACHINE ENCLOSURE FOR STRIP TESTING MACHINE	
PRIORITY NA		
DESIGN NUMBER	255399	
CLASS	08-06	
1)JAYDEEPBHAI K. MAKASANA AN INDIAN NATIONAL SOLE PROPRIETOR OF LEVISH HARDWARE AN INDIAN PROPRIETORSHIP FIRM HAVING ITS PRINCIPAL PLACE OF BUSINESS AT “SHRI KRUSHNA KUNJ□, 5-GOKUL NAGAR, B/H. PUNIT SOCIETY, KOTHARIYA MAIN ROAD, RAJKOT, GUJARAT-INDIA		
DATE OF REGISTRATION	25/07/2013	
TITLE	HANDLE	
PRIORITY NA		
DESIGN NUMBER	255609	
CLASS	01-01	
1)MOHAN BAKERS PRIVATE LIMITED, A COMPANY DULY REGISTERED UNDER THE PROVISIONS OF THE COMPANIES ACT, 1956, WHOSE ADDRESS IS 305 MANGALAM, 24 HEMANTA BASU SARANI, KOLKATA-700001, WEST BENGAL, INDIA		
DATE OF REGISTRATION	01/08/2013	
TITLE	BISCUIT	
PRIORITY NA		

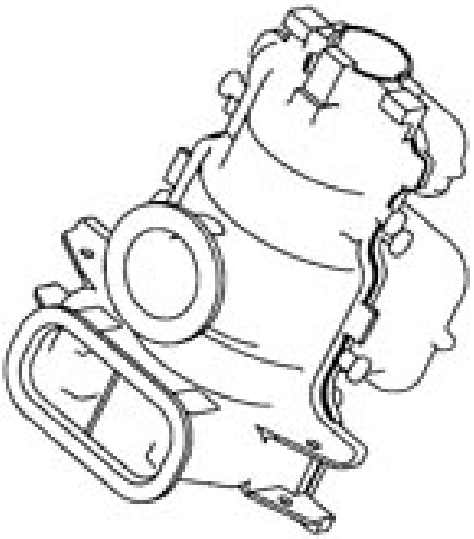
DESIGN NUMBER	254988	
CLASS	15-01	
1)TRIVENI TURBINE LIMITED, AN INDIAN COMPANY HAVING ITS PLACE OF BUSINESS AT 12A, PEENYA INDUSTRIAL AREA, BANGLORE-560058		
DATE OF REGISTRATION	04/07/2013	
TITLE	STEAM CASING OF A BACK PRESSURE TURBINE	
PRIORITY NA		

DESIGN NUMBER	255109	
CLASS	26-06	
1)MARUTI SUZUKI INDIA LIMITED, AN INDIAN COMPANY OF 1, NELSON MANDELA ROAD, VASANT KUNJ, NEW DELHI-110070, INDIA		
DATE OF REGISTRATION	10/07/2013	
TITLE	HEAD LAMP OF A VEHICLE	
PRIORITY NA		

DESIGN NUMBER	253200	
CLASS	21-01	
1)DEEPAK TIWARI, 195-A, SAMARTH PARK COLONY, UMARIA, MHOW, DIST. INDORE, MADHYA PRADESH, PIN-452333, INDIA, AN INDIAN NATIONAL		
DATE OF REGISTRATION	17/04/2013	
TITLE	CHESS BOARD GAME	
PRIORITY NA		

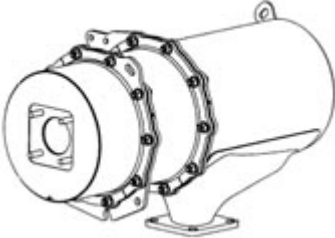
DESIGN NUMBER	253350		
CLASS	28-02		
1)AVON PRODUCTS, INC. 777 THIRD AVENUE NEW YORK, NY 10017 UNITED STATES OF AMERICA			
DATE OF REGISTRATION	23/04/2013		
TITLE	COSMETIC PACKAGE		
PRIORITY			
PRIORITY NUMBER	DATE	COUNTRY	
29/435,348	23/10/2012	U.S.A.	
DESIGN NUMBER	254590		
CLASS	15-01		
1)YANMAR CO., LTD., A CORPORATION ORGANIZED AND EXISTING UNDER THE LAWS OF JAPAN, OF 1-9, TSURUNOCHO, KITA-KU, OSAKA-SHI, OSAKA 5308311, JAPAN			
DATE OF REGISTRATION	19/06/2013		
TITLE	EXHAUST GAS PURIFYING DEVICE FOR ENGINES		
PRIORITY			
PRIORITY NUMBER	DATE	COUNTRY	
2012-31656	26/12/2012	JAPAN	