

INTRODUCTION

In view of the recent amendment made in the Designs (Amendment) Rules, 2008 with effect from 17/06/2008, Publication of the matter relating to Designs is being published in the Official Journal of The Patent Office. This Journal is being published on weekly basis on every Friday covering the various proceedings on Designs as required according to the provisions of under Rule 22, 25, 27 and 39 of the Design (Amendment) Rules, 2008. All the enquiries on this Official Journal and other information as required by the public should be addressed to the Controller General of Patents, Designs & Trade Marks. Suggestions and comments are requested from all quarters so that the content can be enriched.

COPYRIGHT PUBLICATION

SL NO	CASE NUMBERS	RENEWED ON
1.	244858	06.01.2014
2.	245124	10.01.2014
3.	245125	10.01.2014
4.	245281	06.01.2014
5.	245282	06.01.2014
6.	246770	09.01.2014
7.	246771	09.01.2014
8.	247497	09.01.2014
9.	247498	09.01.2014
10.	248152	09.01.2014
11.	248153	09.01.2014
12.	248154	06.01.2014
13.	248054	10.01.2014
14.	248055	10.01.2014
15.	248056	10.01.2014
16.	248057	10.01.2014
17.	248058	10.01.2014
18.	249629	09.01.2014
19.	249632	09.01.2014
20.	249797	06.01.2014
21.	194826	17.01.2014
22.	194827	17.01.2014
23.	194828	17.01.2014
24.	194829	17.01.2014
25.	194830	17.01.2014
26.	250208	09.01.2014
27.	185722	17.01.2014
28.	251682	10.01.2014
29.	251681	10.01.2014
30.	251680	10.01.2014
31.	251470	09.01.2014
32.	251392	09.01.2014
33.	251473	09.01.2014
34.	251393	09.01.2014
35.	251493	09.01.2014
36.	251183	07.01.2014
37.	250211	09.01.2014
38.	185716	17.01.2014
39.	185717	17.01.2014
40.	185718	17.01.2014

THE DESIGNS ACT 2000
SECTION 30
DESIGN ASSIGNMENT

The Design stands in the name of FLEXI BATH APS registered under the Designs Act, 2000 has been assigned in the Register of Designs in the name as follows:-

Design No.	Class	Name
219891	23-02	STOKKE AS OF PARKGATA 6, 6003 ALESUND, NORWAY

REGISTRATION OF DESIGNS

The following designs have been registered. They are now open for public inspection. In the following each entry the Date of Registration is shown. The Priority Number, Priority Date and Priority Country are also shown

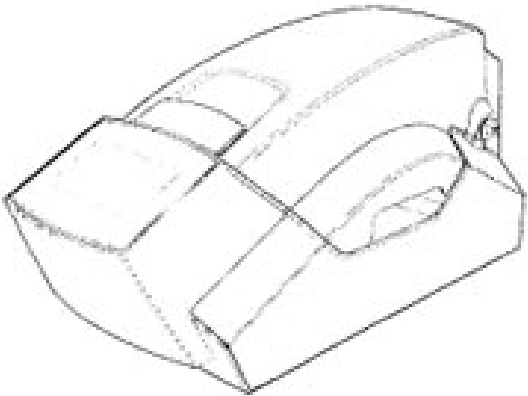
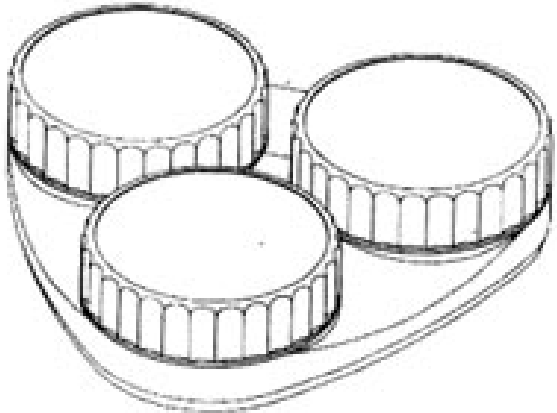
DESIGN NUMBER	241880		
CLASS	15-09		
1)SARTORIUS LAB INSTRUMENTS GMBH & CO. KG. OF WEENDER LANDSTRASSE 94-108, 37075 GOETTINGEN, GERMANY, GERMAN COMPANY			
DATE OF REGISTRATION	27/12/2011		
TITLE	TUBING WELDER		
PRIORITY			
PRIORITY NUMBER	DATE	COUNTRY	
RCD 001903048	10/08/2011	OHIM	
PRIORITY NA			
DESIGN NUMBER	250483		
CLASS	14-99		
1)NILESH RAHATE, AN INDIAN NATIONAL RESIDING AT CUBE DESIGN, 204, RIGHT CHOICE HOUSE, NEAR MRF SHOWROOM, MARUNJI RAOD, HINJEWADI, PUNE-411057			
DATE OF REGISTRATION	26/12/2012		
TITLE	LAPTOP STAND		
PRIORITY NA			
DESIGN NUMBER	253259		
CLASS	09-03		
1)MAHESH PARSANA, INDIAN NATIONAL, OF 402 SUKEN APARTMENT, LIMBUDIWADI MAIN ROAD, RAJKOT 360005, GUJARAT, INDIA			
DATE OF REGISTRATION	19/04/2013		
TITLE	MEDICINE DISPENSER		
PRIORITY NA			

DESIGN NUMBER	254692
CLASS	21-01
1)PLAYTONE PRODUCTS, F-4, GALI NO. 33, MAHENDRA PARK, DELHI-110033, INDIA. (AN INDIAN PROPRIETORSHIP FIRM WHOSE PROPRIETOR IS :- MANJEET LAL SEHGAL. AN INDIAN NATIONAL OF THE ABOVE ADDRESS)	
DATE OF REGISTRATION	24/06/2013
TITLE	TOY DRUM
PRIORITY NA	









DESIGN NUMBER	254736
CLASS	03-01
1)MA DESIGN INDIA PRIVATE LIMITED, A COMPANY INCORPORATED IN INDIA HAVING ITS PRINCIPAL PLACE OF BUSINESS AT A-41, SECTOR-80, PHASE-II, NOIDA-201305, U.P. INDIA	
DATE OF REGISTRATION	25/06/2013
TITLE	BOX FOR CARDS
PRIORITY NA	

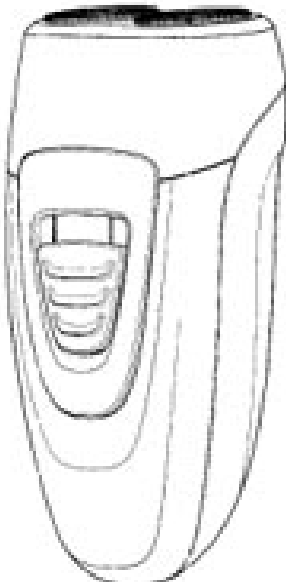

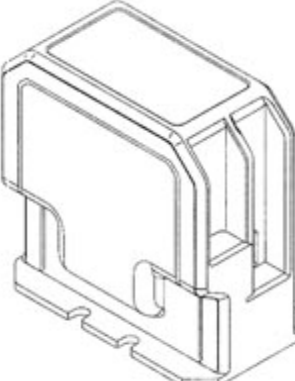

DESIGN NUMBER	254752
CLASS	07-06
1)MA DESIGN INDIA PRIVATE LIMITED, A COMPANY INCORPORATED IN INDIA HAVING ITS PRINCIPAL PLACE OF BUSINESS AT A-41, SECTOR-80, PHASE-II, NOIDA-201305, U.P. INDIA	
DATE OF REGISTRATION	25/06/2013
TITLE	CAKE SERVER
PRIORITY NA	



DESIGN NUMBER	253486		
CLASS	28-03		
1)KONINKLIJKE PHILIPS ELECTRONICS N.V., A COMPANY ORGANIZED AND EXISTING UNDER THE LAWS OF THE KINGDOM OF THE NETHERLANDS, RESIDING AT EINDHOVEN, WHOSE POST-OFFICE ADDRESS IS HIGH TECH CAMPUS 5, 5656 AE EINDHOVEN, THE NETHERLANDS.			
DATE OF REGISTRATION	29/04/2013		
TITLE	TWO HEAD DRY SHAVER		
PRIORITY			
PRIORITY NUMBER	DATE	COUNTRY	
002126706-0001	29/10/2012	OHIM	
DESIGN NUMBER	255337		
CLASS	23-01		
1)M/S. MINTO INDUSTRIES A PARTNERSHIP FIRM REGISTERED UNDER THE PARTNERSHIP ACT, 1932 BETWEEN 1) MR. KAUSHIK HAKMICHAND DOSHI AND 2) MRS. URMILA KAUSHIK DOSHI WHOSE OFFICE IS AT, 217, BHOLA BHAGWAN INDUSTRIAL ESTATE, I.B. PATEL ROAD, GOREGAON (E), MUMBAI-400063, MAHARASHTRA, INDIA			
DATE OF REGISTRATION	18/07/2013		
TITLE	PIPE FITTING		
PRIORITY NA			
DESIGN NUMBER	246606		
CLASS	13-03		
1)EMERSON CLIMATE TECHNOLOGIES, INC., A COMPANY EXISTING UNDER THE LAWS OF UNITED STATES OF AMERICA, AT 1675 W. CAMPBELL ROAD, SIDNEY, OHIO 45365, UNITED STATES OF AMERICA			
DATE OF REGISTRATION	19/07/2012		
TITLE	CONTACTOR HOUSING		
PRIORITY			
PRIORITY NUMBER	DATE	COUNTRY	
29/411,541	23/01/2012	U.S.A.	

DESIGN NUMBER	255561	
CLASS	11-01	
1)R. R. JEWELLERS IS A PARTNERSHIP FIRM REGISTERED UNDER THE PARTNERSHIP ACT, 1932 BETWEEN 1) JIGNESH RAMESHBHAI SHAH 2) TEJAS RAMESHBHAI SHAH AND 3) ALPA JIGNESHBHAI SHAH WHOSE OFFICE IS AT 3RD FLOOR, "PANNA MANEK", OPP. MAA ASHAPURA TEMPLE, PALACE ROAD, RAJKOT-360001, GUJARAT, INDIA		
DATE OF REGISTRATION	30/07/2013	
TITLE	EARRING	
PRIORITY NA		
DESIGN NUMBER	253878	
CLASS	24-01	
1)K. RAJKUMAR, RESIDING AT NO. 7, RAGAVENTHERA NAGAR, NEAR FATHIMA CONVENT, THATTANCHAVADY, PONDICHERY 605 009, INDIA		
DATE OF REGISTRATION	16/05/2013	
TITLE	VETERINARY TABLE	
PRIORITY NA		
DESIGN NUMBER	254842	
CLASS	23-01	
1)BIO-REN SOLUTIONS, AN INDIAN PROPRIETORSHIP FIRM WHOSE PROPRIETOR IS MR. JEETENDER SINGH OF # 348, 2ND MAIN, 3RD STAGE, OPP. TO 15TH CROSS GOKULUM, MYSORE-570002, STATE OF KARNATAKA, INDIA		
DATE OF REGISTRATION	27/06/2013	
TITLE	BIOGAS TANK	
PRIORITY NA		

DESIGN NUMBER	253644		
CLASS	09-03		
1)TIPU SULTAN SHAIKH, PROPRIETOR OF S.T.S. PLASTIC, HAVING HIS OFFICE AT ROOM NO. 1, G-9 CHAWL, MODI COMPOUND, REAY ROAD, MUMBAI-400010, MAHARASHTRA, INDIA			
DATE OF REGISTRATION	03/05/2013		
TITLE	JEWELLERY CASE		
PRIORITY NA			
DESIGN NUMBER	256932		
CLASS	05-05		
1)M/S. BIBA APPARELS PRIVATE LIMITED, AN INDIAN PRIVATE LIMITED COMPANY INCORPORATED UNDER THE PROVISION OF THE COMPANIES ACT, 1956, AND HAVING ITS'S REGISTERED OFFICE AT RELIABLE HOUSE, SITUATED AT HANUMAN SILK MILL COMPOUND, KANJURMARG (WEST), OPP. HUMA MALL, MUMBAI-400078 MAHARASHTRA, INDIA			
DATE OF REGISTRATION	30/09/2013		
TITLE	TEXTILE FABRIC		
PRIORITY NA			
DESIGN NUMBER	247745		
CLASS	15-99		
1)CPS COLOR EQUIPMENT S.P.A. CON UNICO SOCIO, AN ITALIAN COMPANY, VIA, DELL' AGRICOLTURA, 103, 41038 SAN FELICE SUL PANARO (MO), ITALY			
DATE OF REGISTRATION	07/09/2012		
TITLE	COLOUR DISPENSING MACHINES		
PRIORITY			
PRIORITY NUMBER	DATE	COUNTRY	
1320485-0003	02/04/2012	EUROPEAN UNION	

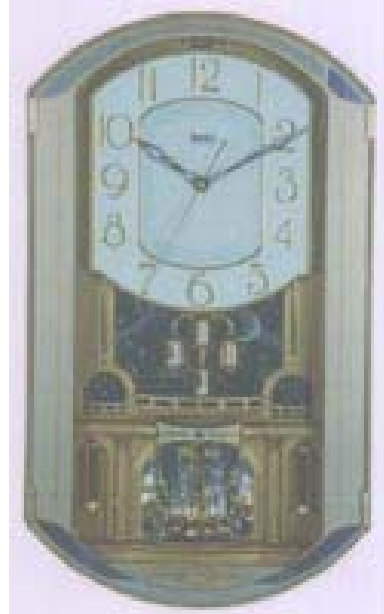
DESIGN NUMBER	252870	
CLASS	10-01	
1)AJANTA LIMITED, AN INDIAN COMPANY OF ORPAT INDUSTRIAL ESTATE, RAJKOT-MORBI HIGHWAY, MORBI 363641, STATE OF GUJARAT, INDIA		
DATE OF REGISTRATION	03/04/2013	
TITLE	CLOCK	
PRIORITY NA		

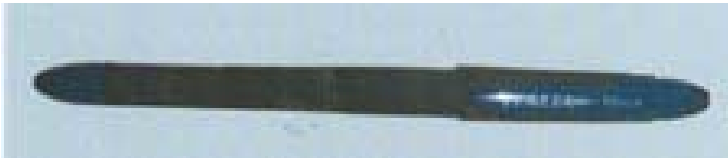
DESIGN NUMBER	253333	
CLASS	19-06	
1)ANCHOR ENTERPRISES PVT. LTD INNOVA 'C' WING, MARATHON NEXTGEN, OFF.G.K.MARG, LOWER PAREL (W), MUMBAI-400013 STATE OF MAHARASHTRA INDIA, / A PRIVATE LIMITED COMPANY INCORPORATED UNDER INDIAN COMPANIES ACT., ABOVE ADDRESS		
DATE OF REGISTRATION	23/04/2013	
TITLE	BALL POINT PEN	
PRIORITY NA		

DESIGN NUMBER	254751	
CLASS	07-01	
1)MA DESIGN INDIA PRIVATE LIMITED, A COMPANY INCORPORATED IN INDIA HAVING ITS PRINCIPAL PLACE OF BUSINESS AT A-41, SECTOR-80, PHASE-II, NOIDA-201305, U.P. INDIA		
DATE OF REGISTRATION	25/06/2013	
TITLE	PLATE	
PRIORITY NA		

DESIGN NUMBER	250125	
CLASS	10-04	
1)CARL ZEISS INDUSTRIELLE MESSTECHNIK GMBH, OF CARL-ZEISS-STRASSE 22 73447 OBERKOCHEN, GERMANY, A GERMAN CAPITAL COMPANY HAVING A LIMITED LIABILITY IN ACCORDANCE WITH GERMAN LAW		
DATE OF REGISTRATION	13/12/2012	
TITLE	RACK FOR STYLUS OF COORDINATE MEASURING MACHINES	
PRIORITY		
PRIORITY NUMBER	DATE	COUNTRY
002066191	29/06/2012	OHIM

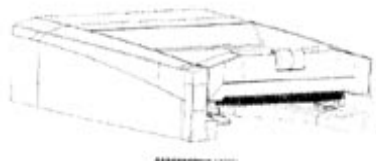



DESIGN NUMBER	250301	
CLASS	02-02	
1)SCALDIS SAINT-MARTIN, SOCIÉTÉ ANONYME OF PARC INDUSTRIEL, RUE DE LA HURTRIE 36, 7600 PERUWELZ, BELGIUM		
DATE OF REGISTRATION	19/12/2012	
TITLE	PROTECTIVE CLOTHES	
PRIORITY		
PRIORITY NUMBER	DATE	COUNTRY
DM/079523	19/06/2012	WIPO





DESIGN NUMBER	238131	
CLASS	12-16	
1)MAHINDRA & MAHINDRA LTD., GATEWAY BUILDING, APOLLO BUNDER, MUMBAI 400001., MAHARASHTRA, INDIA.,		
DATE OF REGISTRATION	19/07/2011	
TITLE	FLOOR CONSOLE OF A VEHICLE	
PRIORITY NA		



DESIGN NUMBER	255336	
CLASS	23-01	
1)M/S. MINTO INDUSTRIES A PARTNERSHIP FIRM REGISTERED UNDER THE PARTNERSHIP ACT, 1932 BETWEEN 1) MR. KAUSHIK HAKMICHAND DOSHI AND 2) MRS. URMILA KAUSHIK DOSHI WHOSE OFFICE IS AT, 217, BHOLA BHAGWAN INDUSTRIAL ESTATE, I.B. PATEL ROAD, GOREGAON (E), MUMBAI-400063, MAHARASHTRA, INDIA		
DATE OF REGISTRATION	18/07/2013	
TITLE	PIPE FITTING	
PRIORITY NA		
DESIGN NUMBER	240116	
CLASS	30-99	
1)INDIAN COUNCIL OF AGRICULTURAL RESEARCH, KRISHI BHAWAN, DR. RAJENDRA PRASAD ROAD, NEW DELHI-110001.		
DATE OF REGISTRATION	12/10/2011	
TITLE	BULK MILK FEEDER FOR ANIMALS	
PRIORITY NA		
DESIGN NUMBER	255560	
CLASS	11-01	
1)R. R. JEWELLERS IS A PARTNERSHIP FIRM REGISTERED UNDER THE PARTNERSHIP ACT, 1932 BETWEEN 1) JIGNESH RAMESHBHAI SHAH 2) TEJAS RAMESHBHAI SHAH AND 3) ALPA JIGNESHBHAI SHAH WHOSE OFFICE IS AT 3RD FLOOR, "PANNA MANEK", OPP. MAA ASHAPURA TEMPLE, PALACE ROAD, RAJKOT-360001, GUJARAT, INDIA		
DATE OF REGISTRATION	30/07/2013	
TITLE	EARRING	
PRIORITY NA		

DESIGN NUMBER	255605	
CLASS	04-02	
1)SHREE SIMANDHAR INDUSTRIES IS A PROPRIETORSHIP FIRM OF 21, NEW MANU BHUVAN, BHAGAT SINGH ROAD, VILE PARLE (W) MUMBAI-400056, MAHARASHTRA, INDIA		
DATE OF REGISTRATION	01/08/2013	
TITLE	TOOTH BRUSH	
PRIORITY NA		
DESIGN NUMBER	254909	
CLASS	08-06	
1)RASIKLAL GHUSABHAI CHOVIYA (ADULT & INDIAN NATIONAL) SOLE PROPRIETOR OF M K TECHNOCAST (INDIAN PROPRIETORSHIP CONCERN) HAVING PLACE OF BUSINESS AT-2, PATEL NAGAR, SADBHAVNA, PLOT, NR: BHAGWATI ENTERPRISE, 50, FEET MAIN ROAD, RAJKOT-GUJARAT-(INDIA)		
DATE OF REGISTRATION	02/07/2013	
TITLE	HANDLE	
PRIORITY NA		
DESIGN NUMBER	254934	
CLASS	15-03	
1)M/S JAGATSUKH INDUSTRIES (REGD), PASSI CHOWK, PAKHOWAL ROAD, LUDHIANA-141013 (PUNJAB) INDIA AN INDIAN PROPRIETORSHIP FIRM WHOSE PROPRIETOR IS:- DALJIT SINGH BEING INDIAN NATIONALS OF THE ABOVE ADDRESS		
DATE OF REGISTRATION	02/07/2013	
TITLE	TANK FOR AGRICULTURAL SPRAYING MACHINE	
PRIORITY NA		

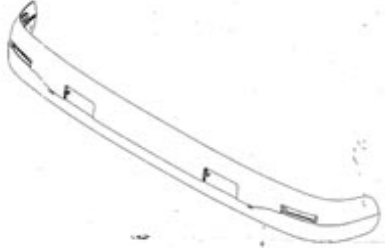

DESIGN NUMBER	251193		
CLASS	13-03		
1)EMERSON ELECTRIC CO., A CORPORATION ORGANIZED UNDER THE LAWS OF THE STATE OF MISSOURI, 8000, WEST FLORISSANT, ST. LOUIS, MISSOURI 63136, UNITED STATES OF AMERICA			
DATE OF REGISTRATION	24/01/2013		
TITLE	HERMETIC TERMINAL		
PRIORITY			
PRIORITY NUMBER	DATE	COUNTRY	
29/429570	14/08/2012	U.S.A.	
DESIGN NUMBER	253643		
CLASS	03-01		
1)TIPU SULTAN SHAIKH, PROPRIETOR OF S.T.S. PLASTIC, HAVING HIS OFFICE AT ROOM NO. 1, G-9 CHAWL, MODI COMPOUND, REAY ROAD, MUMBAI-400010, MAHARASHTRA, INDIA			
DATE OF REGISTRATION	03/05/2013		
TITLE	BANGLE HOLDER		
PRIORITY NA			
DESIGN NUMBER	257049		
CLASS	05-05		
1)M/S. BIBA APPARELS PRIVATE LIMITED, AN INDIAN PRIVATE LIMITED COMPANY INCORPORATED UNDER THE PROVISION OF THE COMPANIES ACT, 1956, AND HAVING ITS'S REGISTERED OFFICE AT RELIABLE HOUSE, SITUATED AT HANUMAN SILK MILL COMPOUND, KANJURMARG (WEST), OPP. HUMA MALL, MUMBAI-400078 MAHARASHTRA, INDIA			
DATE OF REGISTRATION	30/09/2013		
TITLE	TEXTILE FABRIC		
PRIORITY NA			

DESIGN NUMBER	252793		
CLASS	12-16		
1)SCANIA CV AB, SE-151 87, SÖDERTÄLJE, SWEDEN			
DATE OF REGISTRATION	03/04/2013		
TITLE	SUN VISOR FOR VEHICLE		
PRIORITY			
PRIORITY NUMBER	DATE	COUNTRY	
2012/0436	04/10/2012	SWEDEN	
DESIGN NUMBER	254482		
CLASS	08-09		
1)FORMATIVE ENGINEERING PVT. LTD. INDUSTRIAL AREA-C, SUA ROAD, DHANDARI KALAN, LUDHIANA-141 010 (PUNJAB) INDIA (AN INDIAN COMPANY DULY REGISTERED UNDER THE COMPANIES ACT, 1956) OF THE ABOVE ADDRESS			
DATE OF REGISTRATION	13/06/2013		
TITLE	RAIL-HEAD FOR GATES & GRILLS		
PRIORITY NA			
DESIGN NUMBER	254668		
CLASS	09-07		
1)AMZ PACKAGING PVT. LTD., AN INDIAN COMPANY DULY INCORPORATED UNDER THE PROVISIONS OF THE COMPANIES ACT, 1956 HAVING ITS OFFICE AT 48, S. N. ROY ROAD, KOLKATA-700038, WEST BENGAL, INDIA			
DATE OF REGISTRATION	21/06/2013		
TITLE	BOTTLE CAP		
PRIORITY NA			

DESIGN NUMBER	254748	
CLASS	07-01	
1)MA DESIGN INDIA PRIVATE LIMITED, A COMPANY INCORPORATED IN INDIA HAVING ITS PRINCIPAL PLACE OF BUSINESS AT A-41, SECTOR-80, PHASE-II, NOIDA-201305, U.P. INDIA		
DATE OF REGISTRATION	25/06/2013	
TITLE	DISH	
PRIORITY NA		

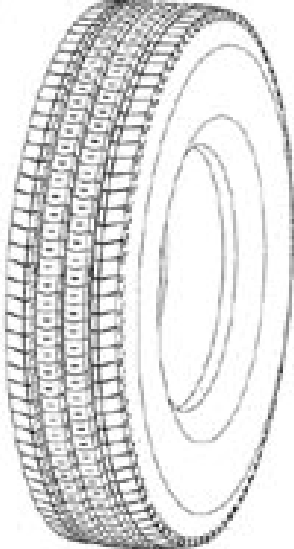
DESIGN NUMBER	254756	
CLASS	07-06	
1)MA DESIGN INDIA PRIVATE LIMITED, A COMPANY INCORPORATED IN INDIA HAVING ITS PRINCIPAL PLACE OF BUSINESS AT A-41, SECTOR-80, PHASE-II, NOIDA-201305, U.P. INDIA		
DATE OF REGISTRATION	25/06/2013	
TITLE	NAPKIN HOLDER	
PRIORITY NA		

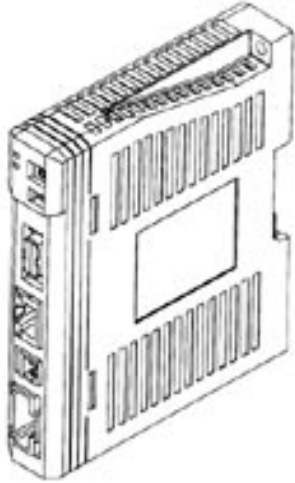
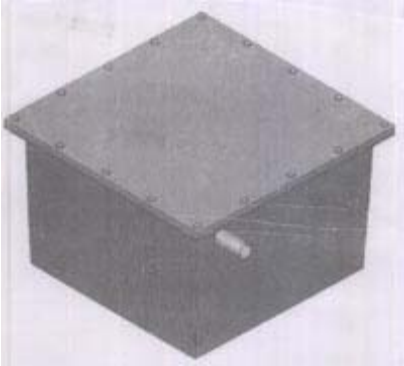

DESIGN NUMBER	254785		
CLASS	12-15		
1)COMPAGNIE GENERALE DES ETABLISSEMENTS MICHELIN, A FRENCH COMPANY OF 12 COURS SABLON, FR-63000, CLERMONT-FERRAND, FRANCE, AND MICHELIN RECHERCHE ET TECHNIQUE S.A., A SWISS COMPANY OF ROUTE LOUIS BRAILLE 10 - CH-1763 GRANGES-PACCOT, SWITZERLAND			
DATE OF REGISTRATION	25/06/2013		
TITLE	TYRE		
PRIORITY			
PRIORITY NUMBER	DATE		COUNTRY
12/5754	26/12/2012		FRANCE
PRIORITY			
PRIORITY NA			

DESIGN NUMBER	251675	
CLASS	14-03	
1)KABUSHIKI KAISHA YASKAWA DENKI A JAPANESE COMPANY OF THE ADDRESS: 2-1, KUROSAKI-SHIROISHI, YAHATANISHI-KU, KITAKYUSHU-SHI, FUKUOKA 806-0004, JAPAN		
DATE OF REGISTRATION	14/02/2013	
TITLE	CONTROLLER FOR ELECTRICAL MACHINERY	
PRIORITY NA		
		
DESIGN NUMBER	252961	
CLASS	23-02	
1)DIRECTOR GENERAL DEFENCE RESEARCH & DEVELOPMENT ORGANISATION MINISTRY OF DEFENCE, GOVERNMENT OF INDIA, ROOM NO. 348, B-WING, DRDO BHAWAN, RAJAJI MARG, NEW DELHI-110105, INDIA, AN INDIAN ORGANISATION		
DATE OF REGISTRATION	08/04/2013	
TITLE	BIO DIGESTER	
PRIORITY NA		
		
DESIGN NUMBER	254209	
CLASS	19-06	
1)KLIO-ETERNA SCHREIBGERÄTE GMBH & CO KG, A GERMAN COMPANY OF GLASHÜTTENWEG 7, 77709 WOLFACH, GERMANY		
DATE OF REGISTRATION	31/05/2013	
TITLE	WRITING PEN	
PRIORITY		
PRIORITY NUMBER	DATE	COUNTRY
712467301	08/01/2013	WIPO
		

DESIGN NUMBER	255556	
CLASS	09-01	
1)LION DATES IMPEX (P) LTD., A PRIVATE LIMITED COMPANY, HAVING ITS REGISTERED OFFICE AT NO. 40, STERLING ROAD, NUNGAMBAKKAM, CHENNAI-600034, TAMILNADU, INDIA		
DATE OF REGISTRATION	30/07/2013	
TITLE	TWIN BOTTLE	
PRIORITY NA		

DESIGN NUMBER	249436	
CLASS	12-16	
1)CONCENTRIC PUMPS PUNE PVT. LTD. A COMPANY REGISTERED UNDER COMPANY ACT 1956 OF GAT NO. 26/1, 27 & 28 (PART), OFF PUNE-NAGAR ROAD, VILLAGE LONIKAND, P.O. LONIKAND, TALUKA HAVELI, PUNE-412216, MAHARASHTRA, INDIA		
DATE OF REGISTRATION	12/11/2012	
TITLE	LUBRICATING OIL PUMP USED IN AUTOMOBILE	
PRIORITY NA		

DESIGN NUMBER	249517	
CLASS	06-01	
1)KNOLL, INC., A DELAWARE CORPORATION, OF 1235 WATER STREET, EAST GREENVILLE, PENNSYLVANIA 18041, UNITED STATES OF AMERICA		
DATE OF REGISTRATION	16/11/2012	
TITLE	CHAIR	
PRIORITY		
PRIORITY NUMBER	DATE	COUNTRY
29/423,807	05/06/2012	U.S.A.

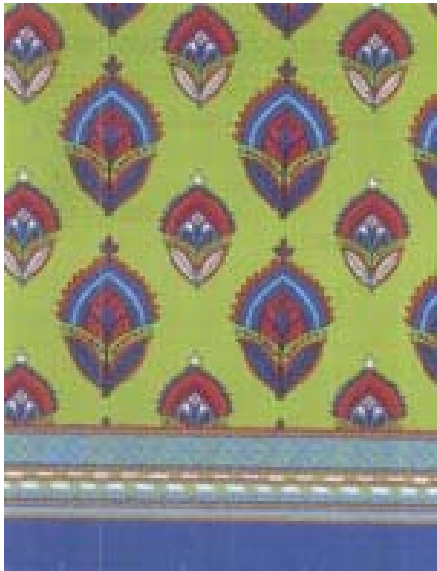
DESIGN NUMBER	250790	
CLASS	09-99	
1)TOPLAND ENGINES PVT. LTD. (A COMPANY INCORPORATED UNDER THE COMPANIES ACT, 1956) HAVING ITS REGISTERED OFFICE AT 2, UMAKANT PANDIT, UDYOGNAGAR, MAVDI PLOT, RAJKOT-360004 (GUJARAT), INDIA, INDIAN COMPANY		
DATE OF REGISTRATION	07/01/2013	
TITLE	CRATE	
PRIORITY NA		
DESIGN NUMBER	253640	
CLASS	02-07	
1)AND DESIGNS INDIA LTD., HAVING THEIR REGISTERED OFFICE AT PLOT NO. 88, MAROL CO-OPERATIVE. INDUSTRIAL ESTATE, M.V. ROAD, MAROL, ANDHERI (EAST), MUMBAI-400059, MAHARASHTRA, INDIA		
DATE OF REGISTRATION	03/05/2013	
TITLE	CUFFLINKS	
PRIORITY NA		
DESIGN NUMBER	256936	
CLASS	05-05	
1)M/S. BIBA APPARELS PRIVATE LIMITED, AN INDIAN PRIVATE LIMITED COMPANY INCORPORATED UNDER THE PROVISION OF THE COMPANIES ACT, 1956, AND HAVING ITS'S REGISTERED OFFICE AT RELIABLE HOUSE, SITUATED AT HANUMAN SILK MILL COMPOUND, KANJURMARG (WEST), OPP. HUMA MALL, MUMBAI-400078 MAHARASHTRA, INDIA		
DATE OF REGISTRATION	30/09/2013	
TITLE	TEXTILE FABRIC	
PRIORITY NA		

DESIGN NUMBER	256944	
CLASS	05-05	
1)M/S. BIBA APPARELS PRIVATE LIMITED, AN INDIAN PRIVATE LIMITED COMPANY INCORPORATED UNDER THE PROVISION OF THE COMPANIES ACT, 1956, AND HAVING ITS'S REGISTERED OFFICE AT RELIABLE HOUSE, SITUATED AT HANUMAN SILK MILL COMPOUND, KANJURMARG (WEST), OPP. HUMA MALL, MUMBAI-400078 MAHARASHTRA, INDIA		
DATE OF REGISTRATION	30/09/2013	
TITLE	TEXTILE FABRIC	
PRIORITY NA		

DESIGN NUMBER	225658	
CLASS	09-03	
1)ORION CORPORATION 30-10, MUNBAE-DONG, YONGSAN-KU, SEOUL, REPUBLIC OF KOREA		
DATE OF REGISTRATION	06/11/2009	
TITLE	PACKAGING BOX FOR CONFECTIONERY	
PRIORITY NA		

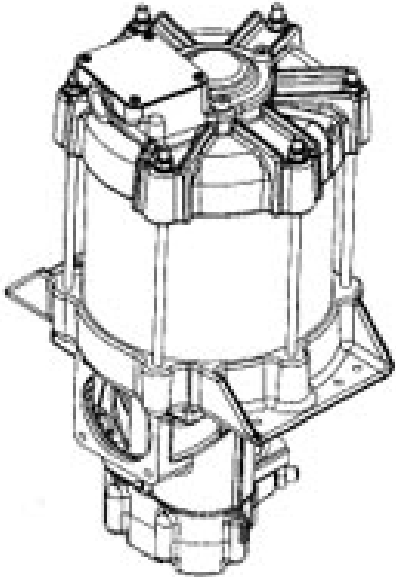
DESIGN NUMBER	250977		
CLASS	15-02		
1)ATLAS COPCO AIRPOWER, NAAMLOZE VENNOOTSCHAP, OF BOOMSESTEENWEG 957, 2610 WILRIJK, BELGIUM, A BELGIAN COMPANY			
DATE OF REGISTRATION	14/01/2013		
TITLE	COMPRESSOR FOR COMPRESSING GASSES		
PRIORITY			
PRIORITY NUMBER	DATE	COUNTRY	
201230400984.4	23/08/2012	CHINA	

DESIGN NUMBER	254395	
CLASS	10-04	
1) FREEMANS MEASURES PVT. LTD, AN INDIAN COMPANY, G. T. ROAD, JUGIANA, LUDHIANA - 141117, PUNJAB, INDIA, AN INDIAN COMPANY		
DATE OF REGISTRATION	07/06/2013	
TITLE	MEASURING TAPE	
PRIORITY NA		

DESIGN NUMBER	254478		
CLASS	12-16		
1) AUDI AG, A JOINT STOCK COMPANY ESTABLISHED UNDER GERMAN LAW, OF 85045 INGOLSTADT, GERMANY			
DATE OF REGISTRATION	13/06/2013		
TITLE	WHEEL RIM		
PRIORITY			
PRIORITY NUMBER	DATE	COUNTRY	
002153528-0006	14/12/2012	OHIM	

DESIGN NUMBER	248429		
CLASS	23-03		
1) PRADEEPKUMAR NANDLAL DHOOT, INDIAN NATIONAL OF GANGAPURWALA, 2275 ADAT BAZAR, AHMEDNAGAR-414001, MAHARASHTRA, INDIA.			
DATE OF REGISTRATION	05/10/2012		
TITLE	INDUCTION COOK TOP		
PRIORITY NA			

DESIGN NUMBER	254658	
CLASS	09-03	
1)BAIJU SURESH MEHTA AND SURESH CHUNILAL MEHTA, BOTH INDIAN NATIONALS TRADING AS DAS PENDAWALA, AN INDIAN REGISTERED PARTNERSHIP FIRM		
DATE OF REGISTRATION	21/06/2013	
TITLE	FOOD PACKAGING	
PRIORITY NA		

DESIGN NUMBER	254754	
CLASS	07-06	
1)MA DESIGN INDIA PRIVATE LIMITED, A COMPANY INCORPORATED IN INDIA HAVING ITS PRINCIPAL PLACE OF BUSINESS AT A-41, SECTOR-80, PHASE-II, NOIDA-201305, U.P. INDIA		
DATE OF REGISTRATION	25/06/2013	
TITLE	COASTER (SET)	
PRIORITY NA		

DESIGN NUMBER	254801	
CLASS	25-01	
1)M. A. JOSEPH AT NO. 12A, B-BLOCK, NAGARJUNA PEARL BAY PUTHIYA ROAD, (VIA) K. P. VALLON ROAD, KADAVANDHARA, ERNAKULAM-682 020, KERALA, INDIA, INDIAN-NATIONAL OF ABOVE ADDRESS		
DATE OF REGISTRATION	25/06/2013	
TITLE	COVER BLOCK PANEL WITH TIE WIRE	
PRIORITY NA		

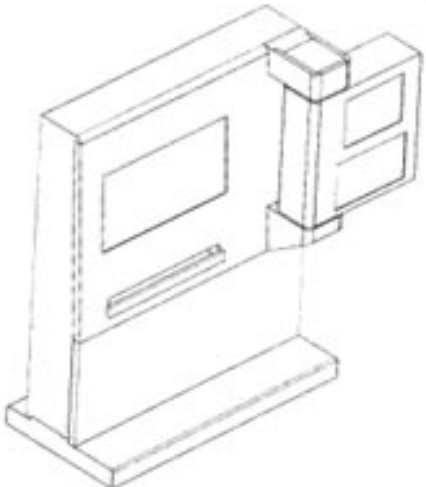
DESIGN NUMBER	250205	
CLASS	15-09	
1)REN AN INFORMATION TECHNOLOGY CO., LTD., A CORPORATION ORGANIZED AND EXISTING UNDER THE LAWS OF TAIWAN, REPUBLIC OF CHINA WHO ARE TAIWANESE BY NATIONALITY AND WHOSE ADDRESS IS 3F, NO. 111, TAICHUNG KANG RD., 3RD SEC., TAICHUNG 407, TAIWAN, REPUBLIC OF CHINA		
DATE OF REGISTRATION	14/12/2012	
TITLE	TRAINING SIMULATOR FOR COMPUTER NUMERIC CONTROL (CNC) MACHINING CENTER	
PRIORITY NA		

DESIGN NUMBER	254253	
CLASS	23-02	
1)KLAUS WAREN FIXTURES PVT. LTD. OF 285, "PARK VIEW" 1ST FLOOR, FLAT NO. 9, B. A. K. ANJAN MARG, OPP. NAPOO GARDEN, MATUNGA (CENTRAL RAILWAY) (E), MUMBAI-400019, MAHARASHTRA, INDIA, INDIAN COMPANY		
DATE OF REGISTRATION	03/06/2013	
TITLE	OVER HEAD SHOWER	
PRIORITY NA		

DESIGN NUMBER	247293	
CLASS	10-02	
1)CHRISTIAN DIOR COUTURE, A FRENCH PUBLIC LIMITED COMPANY OF 30 AVENUE MONTAIGNE, 75008 PARIS, FRANCE		
DATE OF REGISTRATION	22/08/2012	
TITLE	WATCH WITH DECORATIVE ROTATING WEIGHT	
PRIORITY		
PRIORITY NUMBER	DATE	COUNTRY
655236801	27/02/2012	WIPO

DESIGN NUMBER	249433		
CLASS	12-16		
1)CONCENTRIC PUMPS PUNE PVT. LTD. A COMPANY REGISTERED UNDER COMPANY ACT 1956 OF GAT NO. 26/1, 27 & 28 (PART), OFF PUNE-NAGAR ROAD, VILLAGE LONIKAND, P.O. LONIKAND, TALUKA HAVELI, PUNE-412216, MAHARASHTRA, INDIA			
DATE OF REGISTRATION	12/11/2012		
TITLE	ENGINE COOLING WATER PUMP USED IN AUTOMOBILE		
PRIORITY NA			
DESIGN NUMBER	249494		
CLASS	09-07		
1)PLASTICUM GROUP B.V. A DUTCH COMPANY OF THE ADDRESS: 9, ZEVENHEUVELENWEG, 5048 AN TILBURG, THE NETHERLANDS			
DATE OF REGISTRATION	15/11/2012		
TITLE	CAP FOR PACKAGING		
PRIORITY			
PRIORITY NUMBER	DATE	COUNTRY	
002041863-0001	15/05/2012	EUROPEAN UNION	
DESIGN NUMBER	254883		
CLASS	10-04		
1)CADENCE ELECTRONIC SYSTEMS, PLOT NO 4, LUXMI NAGAR, OPP. SECTOR-9, AMBALA CITY-134003, HARYANA, INDIA			
DATE OF REGISTRATION	01/07/2013		
TITLE	COMPRESSION UNIT OF MOISTURE METER		
PRIORITY NA			

DESIGN NUMBER	255097	
CLASS	09-07	
1)UNILEVER PLC, A COMPANY REGISTERED IN ENGLAND AND WALES UNDER COMPANY NO. 41424 OF UNILEVER HOUSE, 100 VICTORIA EMBANKMENT, LONDON, EC4Y 0DY, UNITED KINGDOM		
DATE OF REGISTRATION	09/07/2013	
TITLE	ACTUATOR FOR AEROSOL DISPENSER	
PRIORITY		
PRIORITY NUMBER	DATE	COUNTRY
002163816-0001	09/01/2013	OHIM

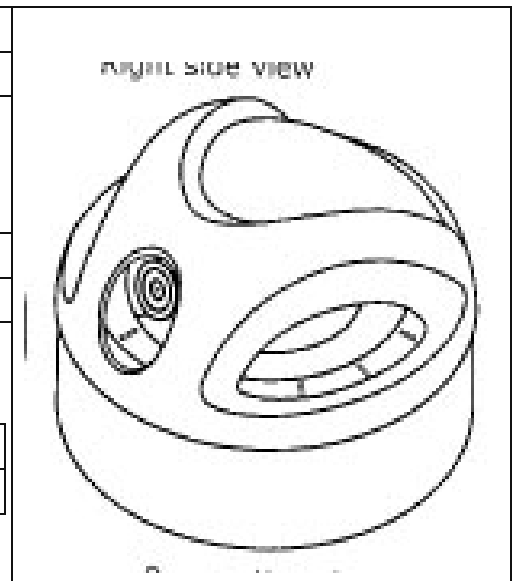

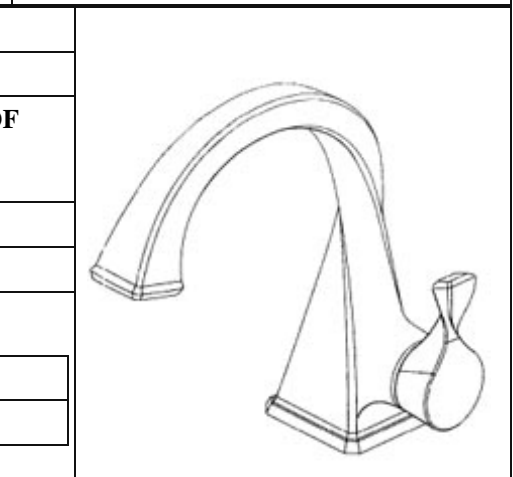

DESIGN NUMBER	248657	
CLASS	23-01	
1)MASCO CORPORATION OF INDIANA, AN INDIANA CORPORATION, OF THE ADDRESS 55 EAST 111TH STREET, INDIANAPOLIS, INDIANA 46280		
DATE OF REGISTRATION	09/10/2012	
TITLE	FAUCET	
PRIORITY		
PRIORITY NUMBER	DATE	COUNTRY
29/418,021	11/04/2012	U.S.A.



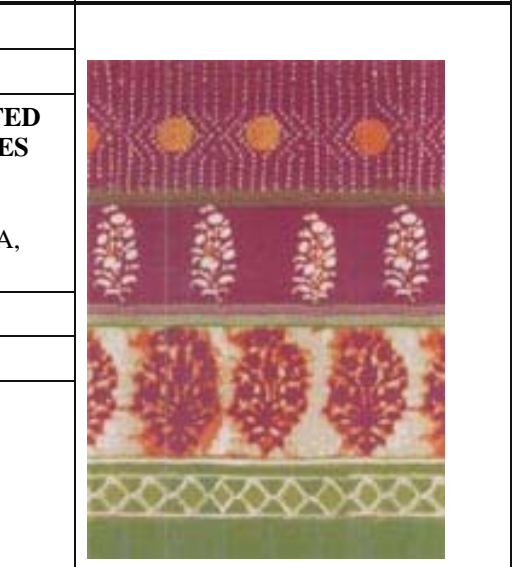

DESIGN NUMBER	256906	
CLASS	05-05	
1)M/S. BIBA APPARELS PRIVATE LIMITED, AN INDIAN PRIVATE LIMITED COMPANY INCORPORATED UNDER THE PROVISION OF THE COMPANIES ACT, 1956, AND HAVING ITS'S REGISTERED OFFICE AT RELIABLE HOUSE, SITUATED AT HANUMAN SILK MILL COMPOUND, KANJURMARG (WEST), OPP. HUMA MALL, MUMBAI-400078 MAHARASHTRA, INDIA		
DATE OF REGISTRATION	30/09/2013	
TITLE	TEXTILE FABRIC	
PRIORITY NA		

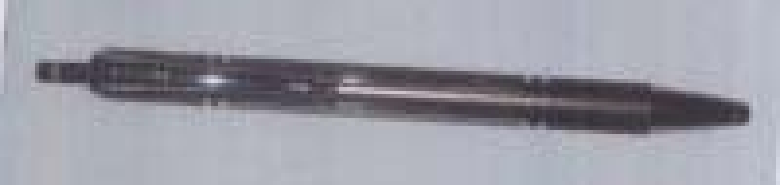

DESIGN NUMBER	257044	
CLASS	05-05	
1)M/S. BIBA APPARELS PRIVATE LIMITED, AN INDIAN PRIVATE LIMITED COMPANY INCORPORATED UNDER THE PROVISION OF THE COMPANIES ACT, 1956, AND HAVING ITS'S REGISTERED OFFICE AT RELIABLE HOUSE, SITUATED AT HANUMAN SILK MILL COMPOUND, KANJURMARG (WEST), OPP. HUMA MALL, MUMBAI-400078 MAHARASHTRA, INDIA		
DATE OF REGISTRATION	30/09/2013	
TITLE	TEXTILE FABRIC	
PRIORITY NA		
DESIGN NUMBER	248430	
CLASS	23-03	
1)PRADEEPKUMAR NANDLAL DHOOT, INDIAN NATIONAL OF GANGAPURWALA, 2275 ADAT BAZAR, AHMEDNAGAR-414001, MAHARASHTRA, INDIA		
DATE OF REGISTRATION	05/10/2012	
TITLE	INDUCTION COOK TOP	
PRIORITY NA		
DESIGN NUMBER	253173	
CLASS	09-01	
1)MR. KAMAL MOTWANI, NATIONALITY INDIAN WHOSE ADDRESS IS SHED NO-24, HSIDC COMPLEX, MANGOLPURI INDUSTRIAL AREA, NEW DELHI-110087 (INDIA)		
DATE OF REGISTRATION	16/04/2013	
TITLE	BOTTLE	
PRIORITY NA		

DESIGN NUMBER	253341	
CLASS	19-06	
1)ANCHOR ENTERPRISES PVT. LTD INNOVA 'C' WING, MARATHON NEXTGEN, OFF.G.K.MARG, LOWER PAREL (W), MUMBAI-400013 STATE OF MAHARASHTRA INDIA, / A PRIVATE LIMITED COMPANY INCORPORATED UNDER INDIAN COMPANIES ACT., ABOVE ADDRESS		
DATE OF REGISTRATION	23/04/2013	
TITLE	BALL POINT PEN	
PRIORITY NA		

DESIGN NUMBER	254745	
CLASS	07-01	
1)MA DESIGN INDIA PRIVATE LIMITED, A COMPANY INCORPORATED IN INDIA HAVING ITS PRINCIPAL PLACE OF BUSINESS AT A-41, SECTOR-80, PHASE-II, NOIDA-201305, U.P. INDIA		
DATE OF REGISTRATION	25/06/2013	
TITLE	DISH	
PRIORITY NA		

DESIGN NUMBER	254755	
CLASS	07-01	
1)MA DESIGN INDIA PRIVATE LIMITED, A COMPANY INCORPORATED IN INDIA HAVING ITS PRINCIPAL PLACE OF BUSINESS AT A-41, SECTOR-80, PHASE-II, NOIDA-201305, U.P. INDIA		
DATE OF REGISTRATION	25/06/2013	
TITLE	PLATTER	
PRIORITY NA		

DESIGN NUMBER	251597	
CLASS	31-00	
1)FIRST ENERGY PVT. LTD., AN INDIAN COMPANY OF B-101 TO B-105, FIRST FLOOR, B-WING, SIGNET CORNER, S.NO-134, BANER, PUNE-411045, INDIA		
DATE OF REGISTRATION	12/02/2013	
TITLE	FRYING PAN	
PRIORITY NA		

DESIGN NUMBER	255243		
CLASS	05-06		
1)LG HAUSYS, LTD., A COMPANY DULY ORGANIZED AND EXISTING UNDER THE LAWS OF RUPUBLIC OF KOREA OF ONE IFC BUILDING, 10 GUKJEGEUMYUNG-RO, YEONGDEUNGPO-GU, SEOUL, REPUBLIC OF KOREA			
DATE OF REGISTRATION	15/07/2013		
TITLE	SYNTHETIC RESIN PAPER		
PRIORITY			
PRIORITY NUMBER	DATE	COUNTRY	
30-2013-0029167	05/06/2013	REPUBLIC OF KOREA	

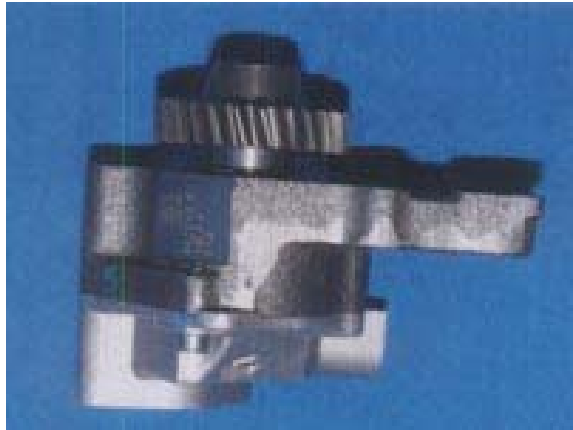
DESIGN NUMBER	249435		
CLASS	12-16		
1)CONCENTRIC PUMPS PUNE PVT. LTD. A COMPANY REGISTERED UNDER COMPANY ACT 1956 OF GAT NO. 26/1, 27 & 28 (PART), OFF PUNE-NAGAR ROAD, VILLAGE LONIKAND, P.O. LONIKAND, TALUKA HAVELI, PUNE-412216, MAHARASHTRA, INDIA			
DATE OF REGISTRATION	12/11/2012		
TITLE	LUBRICATING OIL PUMP USED IN AUTOMOBILE		
PRIORITY NA			

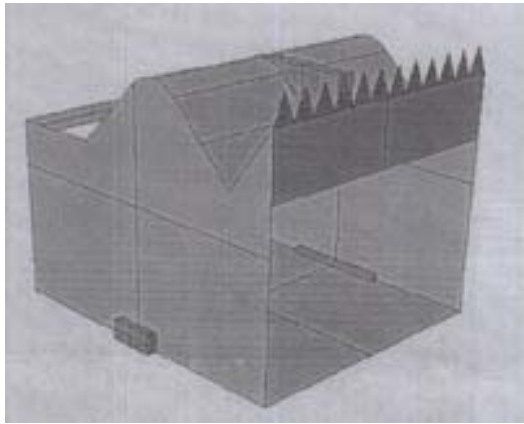
DESIGN NUMBER	249504	
CLASS	19-02	
1)RISHI DOSHI C,5, SIDHI VINAYAR TOWER, TANK LANE, ROLAM, MALED (WEST), MUMBAI-400 0064, INDIA		
DATE OF REGISTRATION	16/11/2012	
TITLE	ADHESIVE TAPE DISPENSER	
PRIORITY NA		

DESIGN NUMBER	253911	
CLASS	02-02	
1)X & O CLOTHING PVT. LTD., (AN INDIAN PRIVATE LIMITED COMPANY REGISTERED UNDER THE INDIAN COMPANIES ACT, 1956), OF 3, THAKUR COMPOUND, 1ST FLOOR, NEXT TO ABB, USV LTD., LANE, OFF. B.S. DEVSHI MARG, GOVANDI(EAST), MUMBAI-400 088, MAHARASHTRA, INDIA.		
DATE OF REGISTRATION	17/05/2013	
TITLE	GARMENT (SET)	
PRIORITY NA		

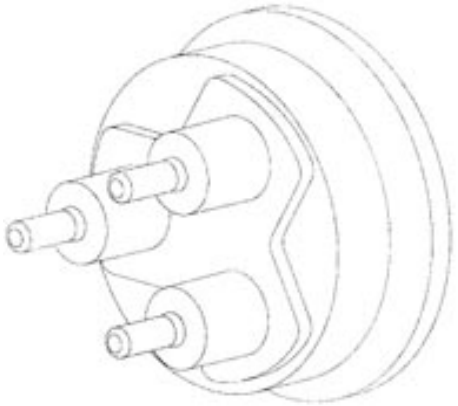

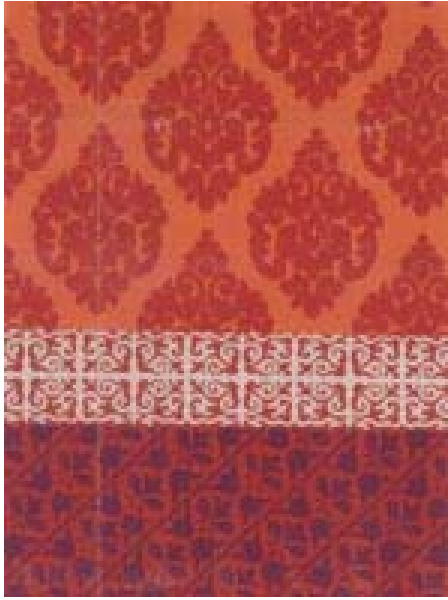

DESIGN NUMBER	251197	
CLASS	13-03	
1)EMERSON ELECTRIC CO., A CORPORATION ORGANIZED UNDER THE LAWS OF THE STATE OF MISSOURI, 8000, WEST FLORISSANT, ST. LOUIS, MISSOURI 63136, UNITED STATES OF AMERICA		
DATE OF REGISTRATION	24/01/2013	
TITLE	HERMETIC TERMINAL	
PRIORITY		
PRIORITY NUMBER	DATE	COUNTRY
29/429570	14/08/2012	U.S.A.

SHEET NO.

DESIGN NUMBER	253639	
CLASS	02-07	
1)AND DESIGNS INDIA LTD., HAVING THEIR REGISTERED OFFICE AT PLOT NO. 88, MAROL CO-OPERATIVE. INDUSTRIAL ESTATE, M.V. ROAD, MAROL, ANDHERI (EAST), MUMBAI-400059, MAHARASHTRA, INDIA		
DATE OF REGISTRATION	03/05/2013	
TITLE	CUFFLINKS	
PRIORITY NA		

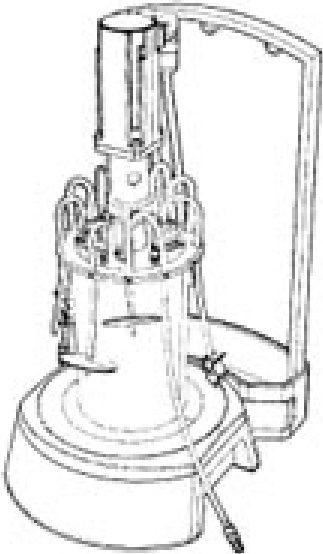
DESIGN NUMBER	256943	
CLASS	05-05	
1)M/S. BIBA APPARELS PRIVATE LIMITED, AN INDIAN PRIVATE LIMITED COMPANY INCORPORATED UNDER THE PROVISION OF THE COMPANIES ACT, 1956, AND HAVING ITS'S REGISTERED OFFICE AT RELIABLE HOUSE, SITUATED AT HANUMAN SILK MILL COMPOUND, KANJURMARG (WEST), OPP. HUMA MALL, MUMBAI-400078 MAHARASHTRA, INDIA		
DATE OF REGISTRATION	30/09/2013	
TITLE	TEXTILE FABRIC	
PRIORITY NA		

DESIGN NUMBER	254473	
CLASS	12-16	
1)AUDI AG, A JOINT STOCK COMPANY ESTABLISHED UNDER GERMAN LAW, OF 85045 INGOLSTADT, GERMANY		
DATE OF REGISTRATION	13/06/2013	
TITLE	WHEEL RIM	
PRIORITY		
PRIORITY NUMBER	DATE	COUNTRY
002153528-0001	14/12/2012	OHIM

DESIGN NUMBER	255867		
CLASS	05-05		
1)PARRY MURRAY & CO. LTD., COMPANY REGISTERED UNDER THE LAWS OF ENGLAND AND WALES, HAVING ITS PRINCIPAL PLACE OF BUSINESS AT 3RD FLOOR, SIMPSON HOUSE, 6 CHERRY ORCHARD ROAD, CROYDON, CRO 6BA, UNITED KINGDOM			
DATE OF REGISTRATION	16/08/2013		
TITLE	TEXTILE FABRIC		
PRIORITY NA			
ESIGN NUMBER	241881		
CLASS	24-01		
1)SARTORIUS LAB INSTRUMENTS GMBH & CO. KG. OF WEENDER LANDSTRASSE 94-108, 37075 GOETTINGEN, GERMANY, GERMAN COMPANY			
DATE OF REGISTRATION	27/12/2011		
TITLE	CELL CULTURING VESSEL		
PRIORITY			
PRIORITY NUMBER	DATE	COUNTRY	
RCD 001287585-0001	02/08/2011	OHIM	
PRIORITY NA			
DESIGN NUMBER	248146		
CLASS	09-03		
1)MR. LALIT KUMAR PALTA (PROPRIETOR), NATIONALITY INDIAN TRADING AS LC PACKERS (INDIAN) WHOSE ADDRESS IS KHASRA NO-107/1A, PRADHANJI KI GALI, HASTSAL INDUSTRIAL AREA, UTTAM NAGAR, NEW DELHI-110059 (INDIA)			
DATE OF REGISTRATION	25/09/2012		
TITLE	JAR		
PRIORITY NA			
PRIORITY			
PRIORITY NUMBER	DATE	COUNTRY	
RCD 001287585-0001	02/08/2011	OHIM	
PRIORITY NA			

DESIGN NUMBER	254737	
CLASS	07-01	
1)MA DESIGN INDIA PRIVATE LIMITED, A COMPANY INCORPORATED IN INDIA HAVING ITS PRINCIPAL PLACE OF BUSINESS AT A-41, SECTOR-80, PHASE-II, NOIDA-201305, U.P. INDIA		
DATE OF REGISTRATION	25/06/2013	
TITLE	CHEESEBOARD	
PRIORITY NA		

DESIGN NUMBER	254753	
CLASS	07-01	
1)MA DESIGN INDIA PRIVATE LIMITED, A COMPANY INCORPORATED IN INDIA HAVING ITS PRINCIPAL PLACE OF BUSINESS AT A-41, SECTOR-80, PHASE-II, NOIDA-201305, U.P. INDIA		
DATE OF REGISTRATION	25/06/2013	
TITLE	DISH	
PRIORITY NA		

DESIGN NUMBER	250261		
CLASS	20-02		
1)HINDUSTAN UNILEVER LIMITED, A COMPANY INCORPORATED UNDER THE INDIAN COMPANIES ACT, 1913, HAVING ITS REGISTERED OFFICE AT UNILEVER HOUSE, B. D. SAWANT MARG, CHAKALA, ANDHERI (EAST), MUMBAI 400099, STATE OF MAHARASHTRA, INDIA			
DATE OF REGISTRATION	17/12/2012		
TITLE	BASKET FOR DISPLAYING PRODUCTS		
PRIORITY			
PRIORITY NUMBER	DATE	COUNTRY	
002059758-0001	19/06/2012	OHIM	



DESIGN NUMBER	251626	
CLASS	25-02	
1)SYNERGY THRISLINGTON, A 1, PHASE-1, INDUSTRIAL AREA, MOHALI-160055 (PUNJAB) INDIA AN INDIAN PROPRIETORSHIP FIRM WHOSE PROPRIETOR IS :- HARPAL SINGH BEING INDIAN NATIONALS OF THE ABOVE ADDRESS		
DATE OF REGISTRATION	14/02/2013	
TITLE	PILLAR FOR BUILDING CONSTRUCTION	
PRIORITY NA		
DESIGN NUMBER	251244	
CLASS	02-03	
1)VEGA AUTO ACCESSORIES PVT LTD., REPRESENTED BY ITS MANAGING DIRECTOR MR. DILIP CHANDAK., HAVING OFFICE AT: NO. 543, VITHALDEV LANE, SHAHAPUR, BELGAUM-590003., NATIONALITY: INDIAN		
DATE OF REGISTRATION	28/01/2013	
TITLE	HELMET	
PRIORITY NA		
DESIGN NUMBER	253595	
CLASS	07-02	
1)M/S GAURAV METAL INDUSTRIES, BEHIND ISHAR SAR GURDWARA, BYE PASS, VILL. PANJ DHERA, PHILLAUR-144410, JALANDHAR (PUNJAB) INDIA AN INDIAN PROPRIETORSHIP FIRM WHOSE PROPRIETOR IS :-HARISH KUMAR GUPTA BEING INDIAN NATIONALS OF THE ABOVE ADDRESS		
DATE OF REGISTRATION	01/05/2013	
TITLE	PLATE FOR BAKING BREAD	
PRIORITY NA		

DESIGN NUMBER	255338	
CLASS	23-01	
1)M/S. MINTO INDUSTRIES A PARTNERSHIP FIRM REGISTERED UNDER THE PARTNERSHIP ACT, 1932 BETWEEN 1) MR. KAUSHIK HAKMICHAND DOSHI AND 2) MRS. URMILA KAUSHIK DOSHI WHOSE OFFICE IS AT, 217, BHOLA BHAGWAN INDUSTRIAL ESTATE, I.B. PATEL ROAD, GOREGAON (E), MUMBAI-400063, MAHARASHTRA, INDIA		
DATE OF REGISTRATION	18/07/2013	
TITLE	PIPE FITTING	
PRIORITY NA		
DESIGN NUMBER	255562	
CLASS	11-01	
1)R. R. JEWELLERS IS A PARTNERSHIP FIRM REGISTERED UNDER THE PARTNERSHIP ACT, 1932 BETWEEN 1) JIGNESH RAMESHBHAI SHAH 2) TEJAS RAMESHBHAI SHAH AND 3) ALPA JIGNESHBHAI SHAH WHOSE OFFICE IS AT 3RD FLOOR, "PANNA MANEK" , OPP. MAA ASHAPURA TEMPLE, PALACE ROAD, RAJKOT-360001, GUJARAT, INDIA		
DATE OF REGISTRATION	30/07/2013	
TITLE	EARRING	
PRIORITY NA		
DESIGN NUMBER	251780	
CLASS	31-00	
1)M/S. UNOVA APPLIANCES PVT. LTD, HAVING THEIR OFFICE AT 1, LAND MARK, OFF. J. P. ROAD, DAWOOD BAUG, 1ST X LANE, ANDHERI (W), MUMBAI-400058, MAHARASHTRA, INDIA		
DATE OF REGISTRATION	19/02/2013	
TITLE	MIXER WITH JUICER JAR	
PRIORITY NA		

DESIGN NUMBER	251904	
CLASS	08-06	
1)(1) MITESHBHAI B. PIPALIYA (2) HITESHBHAI M. PIPALIYA (3) JIGNESHBHAI B. HIRAPARA ALL INDIAN NATIONAL PARTNERS OF PATEL DIE CASTING AN INDIAN PARTNERSHIP FIRM HAVING ITS PRINCIPAL PLACE OF BUSINESS AT PATELNAGAR-4, OPP. SATYANARAYAN MILL, 80 FEET MAIN ROAD, RAJKOT, GUJARAT-INDIA		
DATE OF REGISTRATION	27/02/2013	
TITLE	HANDLE	
PRIORITY NA		

DESIGN NUMBER	254873	
CLASS	08-09	
1)BABUBHAI VASANJIBHAI BHUT AN INDIAN NATIONAL SOLE PROPRIETOR OF PREMIER INDUSTRIES AN INDIAN PROPRIETORSHIP FIRM HAVING ITS PRINCIPAL PLACE OF BUSINESS AT C/O. PREMIER GLASS, SHREE HARI IND. AREA MAIN ROAD, B/H HOTEL AKASH, KOTHARIYA RING ROAD, RAJKOT-360002, GUJARAT-INDIA		
DATE OF REGISTRATION	28/06/2013	
TITLE	DOOR LENS	
PRIORITY NA		

DESIGN NUMBER	254912	
CLASS	08-06	
1)(1) PARESHBHAI VALLABHBHAI VIRADIA (2) RAMNIKBHAI BHIKHUBHAI THUMAR (3) VIJESHBHAI LILABHAI SIDAPARA (ALL THE PARTNERS ARE ADULT & INDIAN NATIONAL) PARTNERS OF SHUBH METAL (INDIAN PARTNERSHIP FIRM) HAVING PLACE OF BUSINESS AT- PARSANA SOCIETY, STREET NO. 3-A, 50 FEET ROAD, KOTHARIYA MAIN ROAD, RAJKOT-360 002-GUJARAT-(INDIA)		
DATE OF REGISTRATION	02/07/2013	
TITLE	HANDLE	
PRIORITY NA		

DESIGN NUMBER	253647	
CLASS	08-07	
1)GODREJ & BOYCE MFG. CO. LTD. OF LOCKS DIVISION (PLANT-18), PIROJSHANAGAR, VIKHROLI, MUMBAI - 400079, MAHARASHTRA, INDIA, INDIAN COMPANY		
DATE OF REGISTRATION	03/05/2013	
TITLE	A BLOCKING UNIT FOR MULTIPOINT LOCK	
PRIORITY NA		
DESIGN NUMBER	256923	
CLASS	05-05	
1)M/S. BIBA APPARELS PRIVATE LIMITED, AN INDIAN PRIVATE LIMITED COMPANY INCORPORATED UNDER THE PROVISION OF THE COMPANIES ACT, 1956, AND HAVING ITS'S REGISTERED OFFICE AT RELIABLE HOUSE, SITUATED AT HANUMAN SILK MILL COMPOUND, KANJURMARG (WEST), OPP. HUMA MALL, MUMBAI-400078 MAHARASHTRA, INDIA		
DATE OF REGISTRATION	30/09/2013	
TITLE	TEXTILE FABRIC	
PRIORITY NA		
DESIGN NUMBER	256933	
CLASS	05-05	
1)M/S. BIBA APPARELS PRIVATE LIMITED, AN INDIAN PRIVATE LIMITED COMPANY INCORPORATED UNDER THE PROVISION OF THE COMPANIES ACT, 1956, AND HAVING ITS'S REGISTERED OFFICE AT RELIABLE HOUSE, SITUATED AT HANUMAN SILK MILL COMPOUND, KANJURMARG (WEST), OPP. HUMA MALL, MUMBAI-400078 MAHARASHTRA, INDIA		
DATE OF REGISTRATION	30/09/2013	
TITLE	TEXTILE FABRIC	
PRIORITY NA		

DESIGN NUMBER	257051	
CLASS	05-05	
1)M/S. BIBA APPARELS PRIVATE LIMITED, AN INDIAN PRIVATE LIMITED COMPANY INCORPORATED UNDER THE PROVISION OF THE COMPANIES ACT, 1956, AND HAVING ITS'S REGISTERED OFFICE AT RELIABLE HOUSE, SITUATED AT HANUMAN SILK MILL COMPOUND, KANJURMARG (WEST), OPP. HUMA MALL, MUMBAI-400078 MAHARASHTRA, INDIA		
DATE OF REGISTRATION	30/09/2013	
TITLE	TEXTILE FABRIC	
PRIORITY NA		
DESIGN NUMBER	247743	
CLASS	15-99	
1)CPS COLOR EQUIPMENT S.P.A. CON UNICO SOCIO, AN ITALIAN COMPANY, VIA, DELL'AGRICOLTURA, 103, 41038 SAN FELICE SUL PANARO (MO), ITALY		
DATE OF REGISTRATION	07/09/2012	
TITLE	COLOUR DISPENSING MACHINES	
PRIORITY		
PRIORITY NUMBER	DATE	COUNTRY
1320485-0001	02/04/2012	EUROPEAN UNION
DESIGN NUMBER	254404	
CLASS	15-02	
1)PRASHANT INDUSTRIES IS A PROPRIETORSHIP FIRM OF OFFICE: PASHAN FLAT HOUSING SOCIETY, A/2 BLDG, FLAT NO. 14, SUS ROAD, PASHAN, PUNE-411021, MAHARASHTRA, INDIA		
DATE OF REGISTRATION	10/06/2013	
TITLE	WATER JET VACUUM PUMP	
PRIORITY NA		



DESIGN NUMBER	254463
CLASS	07-01
1)EXPORTS INTERNATIONAL CORPORATION, 124 E, SAINIK FARMS, CENTRAL AVENUE, LANE C-8/2, NEW DELHI-110062, INDIA, AN INDIAN COMPANY	
DATE OF REGISTRATION	12/06/2013
TITLE	MILK POT WITH LID
PRIORITY NA	



DESIGN NUMBER	253300
CLASS	15-99
1)AKTIEBOLAGET SKF OF 415 50 GOTEBOURG, SWEDEN	
DATE OF REGISTRATION	22/04/2013
TITLE	BEARING HOUSING
PRIORITY NA	



TOP PERSPECTIVE VIEW

DESIGN NUMBER	254684
CLASS	15-01
1)TRIVENI TURBINE LIMITED, AN INDIAN COMPANY HAVING ITS PLACE OF BUSINESS AT 12A, PEENYA INDUSTRIAL AREA, BANGLORE-560058	
DATE OF REGISTRATION	24/06/2013
TITLE	INNER CASING OF A STEAM TURBINE
PRIORITY NA	

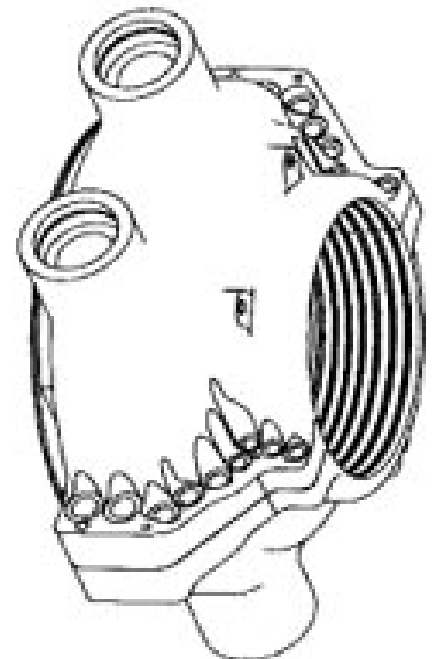

DESIGN NUMBER	254749		
CLASS	07-99		
1)MA DESIGN INDIA PRIVATE LIMITED, A COMPANY INCORPORATED IN INDIA HAVING ITS PRINCIPAL PLACE OF BUSINESS AT A-41, SECTOR-80, PHASE-II, NOIDA-201305, U.P. INDIA			
DATE OF REGISTRATION	25/06/2013		
TITLE	TRAY		
PRIORITY NA			
DESIGN NUMBER	254786		
CLASS	12-15		
1)COMPAGNIE GENERALE DES ETABLISSEMENTS MICHELIN, A FRENCH COMPANY OF 12 COURS SABLON, FR-63000, CLERMONT-FERRAND, FRANCE, AND MICHELIN RECHERCHE ET TECHNIQUE S.A., A SWISS COMPANY OF ROUTE LOUIS BRAILLE 10 - CH-1763 GRANGES-PACCOT, SWITZERLAND			
DATE OF REGISTRATION	25/06/2013		
TITLE	TYRE		
PRIORITY			
PRIORITY NUMBER	DATE	COUNTRY	
12/5755	26/12/2012	FRANCE	
DESIGN NUMBER	250221		
CLASS	15-04		
1)M/S CATERPILLAR INC.; AN AMERICAN CORPORATION, OF THE ADDRESS 100 NE ADAMS STREET, PEORIA, IL 61269, UNITED STATES OF AMERICA			
DATE OF REGISTRATION	17/12/2012		
TITLE	UNDERCARRIAGE TRACK ROLLER FOR MOBILE EARTHMOVING MACHINE		
PRIORITY			
PRIORITY NUMBER	DATE	COUNTRY	
29/426,069	29/06/2012	U.S.A.	

DESIGN NUMBER	251556	
CLASS	09-02	
1)FRIENDSHIP PRODUCTS LLC, INCORPORATED UNDER THE LAWS OF STATE OF CALIFORNIA, U.S.A., OF THE ADDRESS 7401 S. SEPULVEDA BLVD. # 116, LOS ANGELES, CALIFORNIA, 90045, UNITED STATES OF AMERICA		
DATE OF REGISTRATION	11/02/2013	
TITLE	CONTAINER	
PRIORITY		
PRIORITY NUMBER	DATE	COUNTRY
29/422,259	09/08/2012	U.S.A.

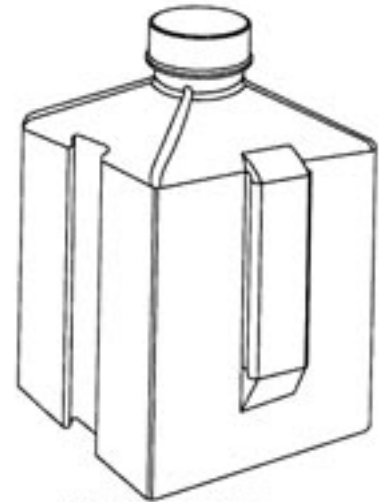

DESIGN NUMBER	251684	
CLASS	14-02	
1)MYTI TECHNETRONICS PVT. LTD, OF 2-2-647/281-282, FLAT NO. 302 SREE HARI NIVAS, SRINIVASA NAGAR COLONY, BAGH AMBERPET, AMBERPET, HYDERABAD, ANDHRA PRADESH-500013, INDIA, AN INDIAN COMPANY		
DATE OF REGISTRATION	15/02/2013	
TITLE	TABLET COMPUTER COVER ASSEMBLY	
PRIORITY NA		



DESIGN NUMBER	251319	
CLASS	23-04	
1)S.C. JOHNSON & SON, INC., A CORPORATION ORGANIZED AND EXISTING UNDER THE LAWS OF THE STATE OF WISCONSIN, UNITED STATES OF AMERICA WHO ARE AMERICAN BY NATIONALITY AND WHOSE ADDRESS IS 1525 HOWE STREET, RACINE, WISCONSIN 53403-2236, UNITED STATES OF AMERICA		
DATE OF REGISTRATION	30/01/2013	
TITLE	VOLATILE MATERIAL DISPENSER	
PRIORITY		
PRIORITY NUMBER	DATE	COUNTRY
29/428,483	31/07/2012	U.S.A.



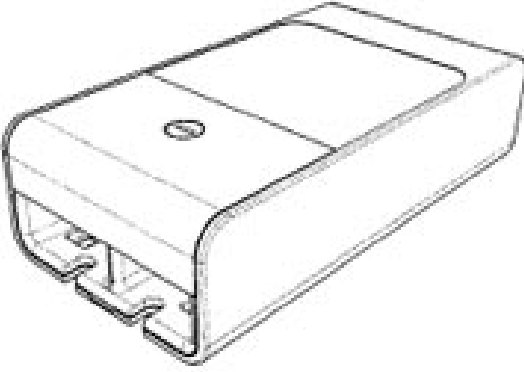

DESIGN NUMBER	253479	
CLASS	08-07	
1)M/S GODANI METAL CO., B-14, INDUSTRIAL ESTATE, ALIGARH-202001 (UTTAR PRADESH), AN INDIAN PARTNERSHIP FIRM WHOSE PARTNERS ARE SH. RAJNEESH GODANI AND SH. RAVI MAHESHWARI (INDIAN NATIONALS)		
DATE OF REGISTRATION	29/04/2013	
TITLE	DOOR BOLT	
PRIORITY NA		

DESIGN NUMBER	255342	
CLASS	05-05	
1)M/S. BIBA APPARELS PRIVATE LIMITED, AN INDIAN PRIVATE LIMITED COMPANY INCORPORATED UNDER THE PROVISION OF THE COMPANIES ACT, 1956, AND HAVING ITS'S REGISTERED OFFICE AT RELIABLE HOUSE, SITUATED AT HANUMAN SILK MILL COMPOUND, KANJURMARG (WEST), OPP. HUMA MALL, MUMBAI-400078 MAHARASHTRA, INDIA		
DATE OF REGISTRATION	18/07/2013	
TITLE	TEXTILE FABRIC	
PRIORITY NA		

DESIGN NUMBER	250058	
CLASS	13-03	
1)EDELCOM, A FRENCH "SOCIETE ANONYME" OF 37 RUE DE LYON, 75012 PARIS, FRANCE		
DATE OF REGISTRATION	11/12/2012	
TITLE	REMOTE CONTROL OF ELECTRICAL NETWORK FOR LIGHT	
PRIORITY		
PRIORITY NUMBER	DATE	COUNTRY
675155001	14/06/2012	WIPO

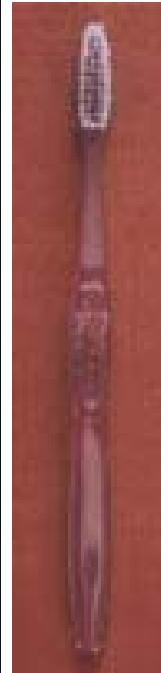
DESIGN NUMBER	255558	
CLASS	11-01	
1)R. R. JEWELLERS IS A PARTNERSHIP FIRM REGISTERED UNDER THE PARTNERSHIP ACT, 1932 BETWEEN 1) JIGNESH RAMESHBHAI SHAH 2) TEJAS RAMESHBHAI SHAH AND 3) ALPA JIGNESHBHAI SHAH WHOSE OFFICE IS AT 3RD FLOOR, 'PANNA MANEK', OPP. MAA ASHAPURA TEMPLE, PALACE ROAD, RAJKOT-360001, GUJARAT, INDIA		
DATE OF REGISTRATION	30/07/2013	
TITLE	EARRING	
PRIORITY NA		
DESIGN NUMBER	255603	
CLASS	04-02	
1)SHREE SIMANDHAR INDUSTRIES IS A PROPRIETORSHIP FIRM OF 21, NEW MANU BHUVAN, BHAGAT SINGH ROAD, VILE PARLE (W) MUMBAI-400056, MAHARASHTRA, INDIA		
DATE OF REGISTRATION	01/08/2013	
TITLE	TOOTH BRUSH	
PRIORITY NA		
DESIGN NUMBER	249450	
CLASS	06-01	
1)HAWORTH, INC., ONE HAWORTH CENTER, HOLLAND, MICHIGAN 49423, UNITED STATES OF AMERICA, A MICHIGAN CORPORATION		
DATE OF REGISTRATION	12/11/2012	
TITLE	OFFICE CHAIR	
PRIORITY		
PRIORITY NUMBER	DATE	COUNTRY
29/422,080	16/05/2012	U.S.A.



DESIGN NUMBER	253641	
CLASS	03-01	
1)TIPU SULTAN SHAIKH, PROPRIETOR OF S.T.S. PLASTIC, HAVING HIS OFFICE AT ROOM NO. 1, G-9 CHAWL, MODI COMPOUND, REAY ROAD, MUMBAI-400010, MAHARASHTRA, INDIA		
DATE OF REGISTRATION	03/05/2013	
TITLE	EARRING HOLDER	
PRIORITY NA		

DESIGN NUMBER	256945	
CLASS	05-05	
1)M/S. BIBA APPARELS PRIVATE LIMITED, AN INDIAN PRIVATE LIMITED COMPANY INCORPORATED UNDER THE PROVISION OF THE COMPANIES ACT, 1956, AND HAVING ITS'S REGISTERED OFFICE AT RELIABLE HOUSE, SITUATED AT HANUMAN SILK MILL COMPOUND, KANJURMARG (WEST), OPP. HUMA MALL, MUMBAI-400078 MAHARASHTRA, INDIA		
DATE OF REGISTRATION	30/09/2013	
TITLE	TEXTILE FABRIC	
PRIORITY NA		

DESIGN NUMBER	241721	
CLASS	09-03	
1)CHINAR FORGE LTD., C-85-86, FOCAL POINT EXTENSION, JALANDHAR-144004 (PUNJAB), INDIA.,		
DATE OF REGISTRATION	23/12/2011	
TITLE	BOX	
PRIORITY NA		

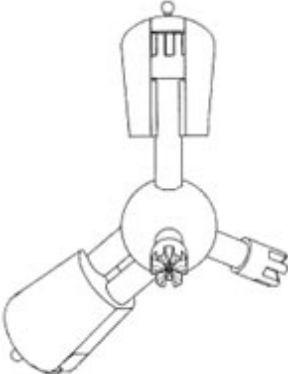
DESIGN NUMBER	247744	
CLASS	15-99	
1)CPS COLOR EQUIPMENT S.P.A. CON UNICO SOCIO, AN ITALIAN COMPANY, VIA, DELL' AGRICOLTURA, 103, 41038 SAN FELICE SUL PANARO (MO), ITALY		
DATE OF REGISTRATION	07/09/2012	
TITLE	COLOUR DISPENSING MACHINES	
PRIORITY		
PRIORITY NUMBER	DATE	COUNTRY
1320485-0002	02/04/2012	EUROPEAN UNION
		
DESIGN NUMBER	252852	
CLASS	10-01	
1)AJANTA LIMITED, AN INDIAN COMPANY OF ORPAT INDUSTRIAL ESTATE, RAJKOT-MORBI HIGHWAY, MORBI 363641, STATE OF GUJARAT, INDIA		
DATE OF REGISTRATION	03/04/2013	
TITLE	CLOCK	
PRIORITY NA		
		
DESIGN NUMBER	254433	
CLASS	21-01	
1)DR. RAGEN PFEIFFER, A GERMAN BY NATIONALITY, EGERLÄNDERSTR. 37 A, 65779 KELKHEIM, GERMANY		
DATE OF REGISTRATION	11/06/2013	
TITLE	MOLECULE MODEL SET	
PRIORITY NA		
		

DESIGN NUMBER	253307	
CLASS	10-04	
1)THE GATES CORPORATION, A DELAWARE CORPORATION OF 1551, WEWATTA STREET, DENVER, CO 80202, U.S.A.		
DATE OF REGISTRATION	23/04/2013	
TITLE	BELT PARAMETER MEASUREMRNT TOOL	
PRIORITY		
PRIORITY NUMBER	DATE	COUNTRY
29/435,777	29/10/2012	U.S.A.

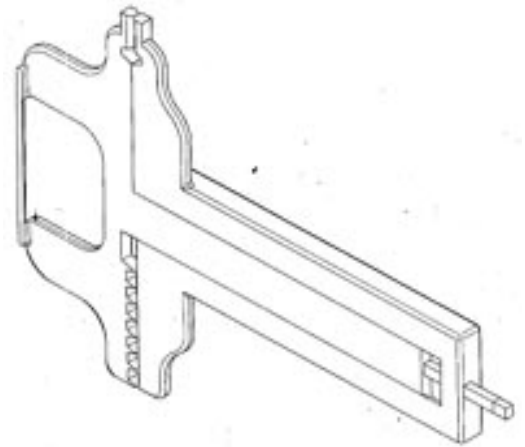





DESIGN NUMBER	254750	
CLASS	07-01	
1)MA DESIGN INDIA PRIVATE LIMITED, A COMPANY INCORPORATED IN INDIA HAVING ITS PRINCIPAL PLACE OF BUSINESS AT A-41, SECTOR-80, PHASE-II, NOIDA-201305, U.P. INDIA		
DATE OF REGISTRATION	25/06/2013	
TITLE	DISH	
PRIORITY NA		

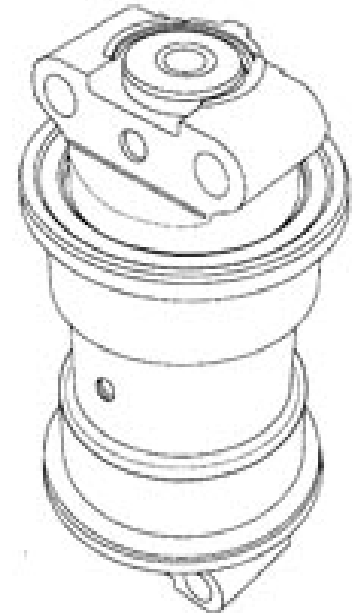

DESIGN NUMBER	250222	
CLASS	15-04	
1)CATERPILLAR INC.; AN AMERICAN CORPORATION, OF THE ADDRESS 100 NE ADAMS STREET, PEORIA, IL 61269, UNITED STATES OF AMERICA		
DATE OF REGISTRATION	17/12/2012	
TITLE	UNDERCARRIAGE TRACK ROLLER FOR MOBILE EARTHMOVING MACHINE	
PRIORITY		
PRIORITY NUMBER	DATE	COUNTRY
29/426,069	29/06/2012	U.S.A.

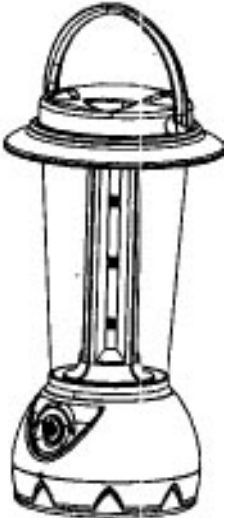

DESIGN NUMBER	255343	
CLASS	05-05	
1)M/S. BIBA APPARELS PRIVATE LIMITED, AN INDIAN PRIVATE LIMITED COMPANY INCORPORATED UNDER THE PROVISION OF THE COMPANIES ACT, 1956, AND HAVING ITS'S REGISTERED OFFICE AT RELIABLE HOUSE, SITUATED AT HANUMAN SILK MILL COMPOUND, KANJURMARG (WEST), OPP. HUMA MALL, MUMBAI-400078 MAHARASHTRA, INDIA		
DATE OF REGISTRATION	18/07/2013	
TITLE	TEXTILE FABRIC	
PRIORITY NA		
DESIGN NUMBER	255559	
CLASS	11-01	
1)R. R. JEWELLERS IS A PARTNERSHIP FIRM REGISTERED UNDER THE PARTNERSHIP ACT, 1932 BETWEEN 1) JIGNESH RAMESHBHAI SHAH 2) TEJAS RAMESHBHAI SHAH AND 3) ALPA JIGNESHBHAI SHAH WHOSE OFFICE IS AT 3RD FLOOR, "PANNA MANEK", OPP. MAA ASHAPURA TEMPLE, PALACE ROAD, RAJKOT-360001, GUJARAT, INDIA		
DATE OF REGISTRATION	30/07/2013	
TITLE	EARRING	
PRIORITY NA		
DESIGN NUMBER	255575	
CLASS	26-02	
1)EVEREADY INDUSTRIES INDIA LTD. 1, MIDDLETON STREET, KOLKATA-700071, WEST BENGAL, INDIA, AN INDIAN COMPANY		
DATE OF REGISTRATION	31/07/2013	
TITLE	LANTERN	
PRIORITY NA		

DESIGN NUMBER	249467	
CLASS	09-03	
1)EMAMI LIMITED, AN INDIAN COMPANY HAVING ITS REGISTERED OFFICE AT 'EMAMI TOWER', 687 ANANDAPUR, EM BYPASS, KOLKATA 700017, WEST BENGAL, INDIA		
DATE OF REGISTRATION	14/11/2012	
TITLE	PACKAGING BOX	
PRIORITY NA		
DESIGN NUMBER	254908	
CLASS	08-06	
1)DAMJIBHAI LAXMANBHAI SORATHIYA (ADULT & INDIAN NATIONAL) PROPRIETOR OF NEW RAMESHWAR ENTERPRISE (INDIAN PROPRIETORSHIP CONCERN) HAVING PLACE OF BUSINESS AT -7, PATEL NAGAR, 80 FEET MAIN ROAD, RAJKOT-360 002-GUJARAT (INDIA)		
DATE OF REGISTRATION	02/07/2013	
TITLE	HANDLE	
PRIORITY NA		
DESIGN NUMBER	254933	
CLASS	15-03	
1)M/S JAGATSUKH INDUSTRIES (REGD), PASSI CHOWK, PAKHOWAL ROAD, LUDHIANA-141013 (PUNJAB) INDIA AN INDIAN PROPRIETORSHIP FIRM WHOSE PROPRIETOR IS:- DALJIT SINGH BEING INDIAN NATIONALS OF THE ABOVE ADDRESS		
DATE OF REGISTRATION	02/07/2013	
TITLE	TANK FOR AGRICULTURAL SPRAYING MACHINE	
PRIORITY NA		

DESIGN NUMBER	237377	
CLASS	07-02	
1)BABY BULLET, LLC 11755 WILSHIRE BLVD, SUITE 1200, LOS ANGELES CALIFORNIA 90025, U.S.A.,		
DATE OF REGISTRATION	17/06/2011	
TITLE	KITCHEN FOOD PROCESSOR CONTAINER	
PRIORITY		
PRIORITY NUMBER	DATE	COUNTRY
29381541	20/12/2010	U.S.A.



DESIGN NUMBER	248585	
CLASS	12-16	
1)HUDSON BAY HOLDING B.V. (A PRIVATE LIMITED COMPANY ORGANIZED AND EXISTING UNDER THE LAWS OF NETHERLANDS), HAVING ITS REGISTERED OFFICE AT: TERLUCHT 17 NL-4458SC 'S-HEER ARENDSKERKE PAÍSES BAJOS, NETHERLANDS		
DATE OF REGISTRATION	12/10/2012	
TITLE	COCKPIT FOR VEHICLE	
PRIORITY		
PRIORITY NUMBER	DATE	COUNTRY
002025981-003	13/04/2012	OHIM



DESIGN NUMBER	251103	
CLASS	06-11	
1)WILLIAM GOODACRE & SONS INDIA PVT. LTD., A COMPANY DULY REGISTERED UNDER THE COMPANIES ACT, 1956, HAVING ADDRESS AT XVIII/1146 REVI KARUNAKARAN ROAD, ALLEPPEY, KERALA-688012		
DATE OF REGISTRATION	22/01/2013	
TITLE	FLOOR MAT	
PRIORITY NA		



DESIGN NUMBER	253642	
CLASS	09-03	
1)TIPU SULTAN SHAIKH, PROPRIETOR OF S.T.S. PLASTIC, HAVING HIS OFFICE AT ROOM NO. 1, G-9 CHAWL, MODI COMPOUND, REAY ROAD, MUMBAI-400010, MAHARASHTRA, INDIA		
DATE OF REGISTRATION	03/05/2013	
TITLE	JEWELLERY CASE	
PRIORITY NA		

DESIGN NUMBER	253784	
CLASS	08-01	
1)NATIONAL OILWELL VARCO UK LIMITED, A BRITISH COMPANY, OF MARTIN STREET, AUDENSHAW, MANCHESTER, M34 5JA, UNITED KINGDOM		
DATE OF REGISTRATION	13/05/2013	
TITLE	WIRELINE ROLLER TOOL	
PRIORITY		
PRIORITY NUMBER	DATE	COUNTRY
002135046-0001	13/11/2012	OHIM