

INTRODUCTION

In view of the recent amendment made in the Designs (Amendment) Rules, 2008 with effect from 17/06/2008, Publication of the matter relating to Designs is being published in the Official Journal of The Patent Office. This Journal is being published on weekly basis on every Friday covering the various proceedings on Designs as required according to the provisions of under Rule 22, 25, 27 and 39 of the Design (Amendment) Rules, 2008. All the enquiries on this Official Journal and other information as required by the public should be addressed to the Controller General of Patents, Designs & Trade Marks. Suggestions and comments are requested from all quarters so that the content can be enriched.

COPYRIGHT PUBLICATION

SL NO	CASE NUMBERS	RENEWED ON
1.	192498	28.11.2013
2.	199330	31.10.2013
3.	194742	28.11.2013
4.	193410	28.11.2013
5.	192709	14.11.2013
6.	192586	31.10.2013
7.	188091	03.01.2014
8.	192693	09.01.2014
9.	186878	09.01.2014
10.	186877	09.01.2014
11.	186876	09.01.2014
12.	186809	09.01.2014

**RESTORATION OF LAPSED DESIGNS
UNDER SECTION 12 (2) OF THE DESIGNS ACT, 2000**

(01)

An application made under Section 12 (2) of the Designs act, 2000 on 22.07.2013, for Restoration of Design No.192498 dated 02.07.2003 in the name of NILKAMAL LIMITED OF SURVEY NO.-354/2 & 354/3, NEAR RAKHOLI BRIDGE, SILVASSA-KHANVEL ROAD, VILLAGE VASONA, SILVASSA (D & N.H.), (U.T.), INDIA has been allowed.

(02)

An application made under Section 12 (2) of the Designs act, 2000 on 04.06.2012, for Restoration of Design No.188091 dated 11.02.2002 in the name of LARSEN & TOUBRO LIMITED, AN INDIAN COMPANY, OF L & T HOUSE, BALLARD ESTATE, MUMBAI-400001, MAHARASHTRA, INDIA has been allowed.

THE DESIGNS ACT 2000
SECTION 30
DESIGN ASSIGNMENT

The Design stands in the name of **ELWYN NG KWANG LING** registered under the Designs Act, 2000 has been assigned in the Register of Designs in the name as follows:-

Design No.	Class	Name
242169	28-03	OSIM INTERNATIONAL LTD., A COMPANY INCORPORATED UNDER THE LAWS OF SINGAPORE, HAVING ADDRESS AT 65 UBI AVENUE 1, OSIM HEADQUARTERS, SINGAPORE 408939

REGISTRATION OF DESIGNS

The following designs have been registered. They are now open for public inspection. In the following each entry the Date of Registration is shown. The Priority Number, Priority Date and Priority Country are also shown

DESIGN NUMBER	252698	
CLASS	21-01	
1)M/S AIR SPORTS, #21, 2ND FLOOR, HIMALAYA SCHOOL BUILDING, BEHIND SHANTHI SAGAR HOTEL, UTTARAHALLI MAIN ROAD, BANGALORE-560061, INDIA, NATIONALITY: INDIAN		
DATE OF REGISTRATION	28/03/2013	
TITLE	TOY PLANE	
PRIORITY NA		
DESIGN NUMBER	252741	
CLASS	08-06	
1)LALJIBHAI PANCHABHAI ROKAD (INDIAN NATIONAL) AND SOLE PROPRIETOR OF SITARAM METAL HAVING PLACE OF BUSINESS AT-3, PATEL NAGAR, 80 FEET ROAD, OPP: PATEL TOOLS, RAJKOT-360002 - GUJARAT (INDIA)		
DATE OF REGISTRATION	02/04/2013	
TITLE	HANDLE	
PRIORITY NA		
DESIGN NUMBER	252764	
CLASS	06-01	
1)ERGOFORM DESIGN, NO. 17/18, 2ND MAIN, 2ND CROSS, CHELEKERE, KALYAN NAGAR POST, BANGALORE PIN-560043, KARNATAKA, NATIONALITY: INDIAN		
DATE OF REGISTRATION	02/04/2013	
TITLE	SOFA	
PRIORITY NA		

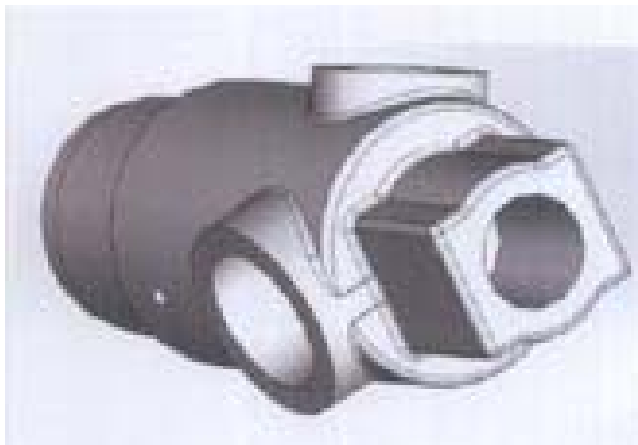
DESIGN NUMBER	252774	
CLASS	23-99	
1)MINDA INDUSTRIES LTD. (AUTOGAS DIVISION) AN INDIAN COMPANY OF VILLAGE NAHARPUR KASAN, P.O. NAKHROLA, IMT MANESAR, DISTT. GURGAON, HARYANA-122050		
DATE OF REGISTRATION	02/04/2013	
TITLE	INLET VALVE FOR HIGH PRESSURE GAS REGULATOR	
PRIORITY NA		

DESIGN NUMBER	252846	
CLASS	23-04	
1)EBM-PAPST MULFINGEN GMBH & CO. KG, OF BACHMÜHLE 2, 74673 MULFINGEN, GERMANY, A GERMAN COMPANY		
DATE OF REGISTRATION	03/04/2013	
TITLE	ELECTRICAL FANS	
PRIORITY		
PRIORITY NUMBER	DATE	COUNTRY
002117408	11/10/2012	OHIM

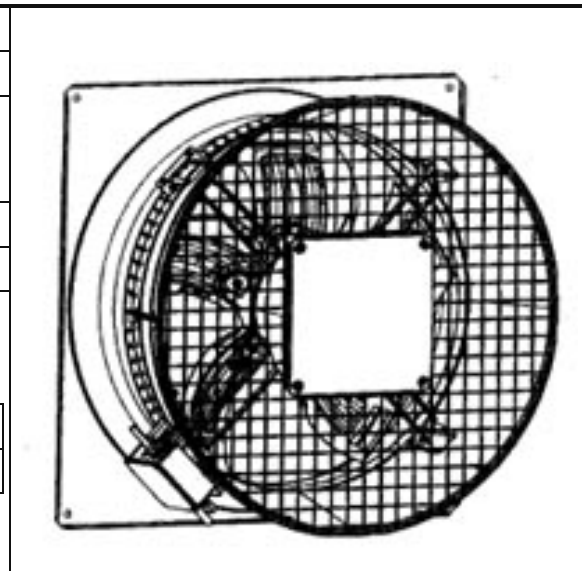

DESIGN NUMBER	250545	
CLASS	23-03	
1)M/S V-GUARD INDUSTRIES LTD., AN INDIAN COMPANY INCORPORATED UNDER THE COMPANIES ACT OF 1956 WHOSE ADDRESS IS 33/2905 F, VENNALA HIGH SCHOOL ROAD, VENNALA, KOCHI-682028, KERALA STATE, INDIA		
DATE OF REGISTRATION	31/12/2012	
TITLE	WATER HEATERS	
PRIORITY NA		



DESIGN NUMBER	250553	
CLASS	31-00	
1)M/S V-GUARD INDUSTRIES LTD., AN INDIAN COMPANY INCORPORATED UNDER THE COMPANIES ACT OF 1956 WHOSE ADDRESS IS 33/2905 F, VENNALA HIGH SCHOOL ROAD, VENNALA, KOCHI-682028, KERALA STATE, INDIA		
DATE OF REGISTRATION	31/12/2012	
TITLE	MIXER	
PRIORITY NA		

DESIGN NUMBER	253171	
CLASS	12-08	
1)CHRYSLER GROUP LLC, 800 CHRYSLER DRIVE EAST, AUBURN HILLS, MICHIGAN 48326-2766, U.S.A.		
DATE OF REGISTRATION	16/04/2013	
TITLE	AUTOMOBILE BODY	
PRIORITY		
PRIORITY NUMBER	DATE	COUNTRY
29/434,717	16/10/2012	U.S.A.

DESIGN NUMBER	254459	
CLASS	11-02	
1)EXPORTS INTERNATIONAL CORPORATION, 124 E, SAINIK FARMS, CENTRAL AVENUE, LANE C-8/2, NEW DELHI-110062, INDIA, AN INDIAN COMPANY		
DATE OF REGISTRATION	12/06/2013	
TITLE	FLOWER VASE	
PRIORITY NA		

DESIGN NUMBER	253887	
CLASS	09-03	
1)SUNITA PURI (AN INDIAN NATIONAL) TRADING AS M/S. DELUX PETROCHEM (INDIA), B-91, CO-OPERATIVE INDUSTRIAL ESTATE, UDYOG NAGAR, KANPUR, U.P.		
DATE OF REGISTRATION	16/05/2013	
TITLE	CONTAINER	
PRIORITY NA		
		
DESIGN NUMBER	253924	
CLASS	08-08	
1)(1) MEHULBHAI D. CHAVDA (2) SOMESHBHAI S. MALIK AND (3) DHIRENBHAI SHAH ALL INDIAN NATIONAL PARTNER OF DMS ARCHITECTURAL PRODUCTS AN INDIAN PARTNERSHIP FIRM HAVING ITS PRINCIPAL PLACE OF BUSINESS AT ADDRESS: PLOT NO. 6, SURVEY NO. 20, EVEREST INDUSTRIAL AREA, NEAR PERFECT (TATA) SHOWROOM, NATIONAL HIGHWAY NO. 8-B, VAVDI-DIST. RAJKOT-360004, GUJARAT-INDIA		
DATE OF REGISTRATION	17/05/2013	
TITLE	CURTAIN BRACKET	
PRIORITY NA		
		
DESIGN NUMBER	252933	
CLASS	23-02	
1)ALFAWALL AB, OF HANS STAHLES VÄG 7, SE-147 41 TUMBA, SWEDEN, A SWEDISH COMPANY		
DATE OF REGISTRATION	05/04/2013	
TITLE	WATER TREATMENT REACTOR	
PRIORITY		
PRIORITY NUMBER	DATE	COUNTRY
002133736-0003	09/11/2012	OHIM
		

DESIGN NUMBER	254147	
CLASS	08-08	
1)PERFECT INDUSTRIES (INDIA) C-65, PHASE-V, FOCAL POINT, LUDHIANA-141 010 (PUNJAB) INDIA AN INDIAN PARTNERSHIP FIRM WHOSE PARTNERS ARE:- SEWA SINGH, KULWANT SINGH, MANINDER SINGH & AMRIT KAUR BEING INDIAN NATIONALS OF THE ABOVE ADDRESS		
DATE OF REGISTRATION	29/05/2013	
TITLE	BOLT	
PRIORITY NA		
DESIGN NUMBER	254182	
CLASS	24-02	
1)KONINKLIJKE PHILIPS N.V., A COMPANY ORGANIZED AND EXISTING UNDER THE LAWS OF THE KINGDOM OF THE NETHERLANDS, RESIDING AT EINDHOVEN, WHOSE POST-OFFICE ADDRESS IS HIGH TECH CAMPUS 5, 5656 AE EINDHOVEN, THE NETHERLANDS		
DATE OF REGISTRATION	30/05/2013	
TITLE	DISPOSABLE AIRWAY ADAPTER FOR RESPIRATORY GAS MONITORING	
PRIORITY		
PRIORITY NUMBER	DATE	COUNTRY
002148825-0001	06/12/2012	OHIM
DESIGN NUMBER	254224	
CLASS	02-04	
1)DELHI PLASTIC, T-1/118, MANGOLPURI INDUSTRIAL AREA, PHASE-1, DELHI-110083, INDIA. (AN INDIAN PROPRIETORSHIP FIRM WHOSE PROPRIETOR IS :-SH. ANIL BANSAL. AN INDIAN NATIONAL OF THE ABOVE ADDRESS		
DATE OF REGISTRATION	31/05/2013	
TITLE	SHOE	
PRIORITY NA		

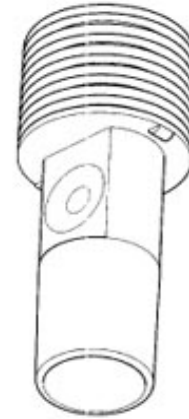

DESIGN NUMBER	254237
CLASS	07-06
1)MA DESIGN INDIA PRIVATE LIMITED, A COMPANY INCORPORATED IN INDIA HAVING ITS PRINCIPAL PLACE OF BUSINESS AT A-41, SECTOR-80, PHASE-II, NOIDA-201305, U.P. INDIA	
DATE OF REGISTRATION	03/06/2013
TITLE	NAPKIN HOLDER
PRIORITY NA	



DESIGN NUMBER	252466
CLASS	31-00
1)CROMPTON GREAVES LIMITED, (AN INDIAN COMPANY), AVANTHA HOUSE, 6TH FLOOR, DR. ANNIE BESANT ROAD, WORLI, MUMBAI-400030, MAHARASHTRA, INDIA	
DATE OF REGISTRATION	20/03/2013
TITLE	MIXER GRINDER
PRIORITY NA	





DESIGN NUMBER	251849
CLASS	12-16
1)MINDA INDUSTRIES LTD. (LIGHTING DIVISION), AN INDIAN COMPANY OF 34-35, K.M. G. T. ROAD, VILL. SONIPAT, HARYANA-131029, INDIA	
DATE OF REGISTRATION	25/02/2013
TITLE	HEAD LAMP
PRIORITY NA	



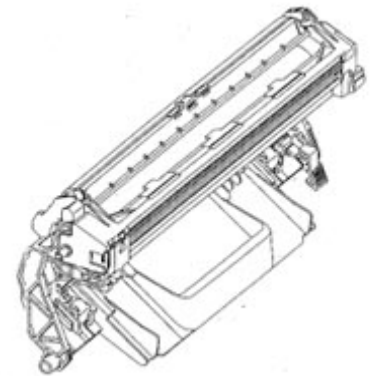

DESIGN NUMBER	254771	
CLASS	09-01	
1)M/S KEVA INDUSTRIES, NEAR OCTROI POST, G. T. ROAD, SAHNEWAL, LUDHIANA-141120 (PUNJAB) INDIA AN INDIAN PROPRIETORSHIP FIRM WHOSE PROPRIETOR IS:- KARAN GOEL BEING INDIAN NATIONALS OF THE ABOVE ADDRESS		
DATE OF REGISTRATION	25/06/2013	
TITLE	BOTTLE	
PRIORITY NA		
DESIGN NUMBER	250910	
CLASS	31-00	
1)MR. S. AMJAD ALI S/O. S. SHOKAT ALI AN INDIAN NATIONAL SOLE PROPRIETOR OF M/S. ZOREEN ENGINEERING & MECHANICAL WORKS AN INDIAN PROPRIETORSHIP FIRM, HAVING ITS PRINCIPAL PLACE OF BUSINESS AT 8/8, B-SECTOR INDUSTRIAL AREA, GOVINDPURA, BHOPAL-462023 (M.P.) INDIA		
DATE OF REGISTRATION	10/01/2013	
TITLE	FLOUR MILLING MACHINE	
PRIORITY NA		
DESIGN NUMBER	252042	
CLASS	13-99	
1)BHARAT HEAVY ELECTRICALS LIMITED, WITH ONE OF ITS REGIONAL OFFICES AT REGIONAL OPERATIONS DIVISION (ROD), PLOT NO. 9/1, DJ BLOCK, 3RD FLOOR, KARUNAMOYEE, SLAT LAKE CITY, KOLKATA-700091, HAVING ITS REGISTERED OFFICE AT BHEL HOUSE SIRI FORT, NEW DELHI-110049, INDIA, AN INDIAN COMPANY		
DATE OF REGISTRATION	04/03/2013	
TITLE	POWER PACK WITH ACOUSTIC ENCLOSURE	
PRIORITY NA		

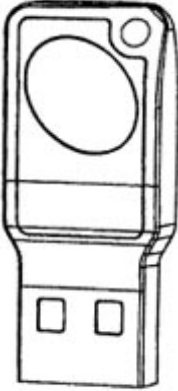
DESIGN NUMBER	253440	
CLASS	13-02	
1)MANIKA MOULDS PVT. LTD., A COMPANY INCORPORATED UNDER THE INDIAN COMPANIES ACT, AAR-PEE CENTRE, 601-605, 6TH FLOOR GUFFIC COMPOUND, MIDC, ANDHERI (E), MUMBAI-400093, MAHARASHTRA, INDIA		
DATE OF REGISTRATION	26/04/2013	
TITLE	BATTERY CONTAINER	
PRIORITY NA		
DESIGN NUMBER	253578	
CLASS	28-03	
1)KONINKLIJKE PHILIPS ELECTRONICS N.V., A COMPANY ORGANIZED AND EXISTING UNDER THE LAWS OF THE KINGDOM OF THE NETHERLANDS, RESIDING AT EINDHOVEN, WHOSE POST-OFFICE ADDRESS IS HIGH TECH CAMPUS 5, 5656 AE EINDHOVEN, THE NETHERLANDS		
DATE OF REGISTRATION	30/04/2013	
TITLE	HANDLE FOR ELECTRIC TOOTHBRUSH	
PRIORITY		
PRIORITY NUMBER	DATE	COUNTRY
002128819-0001	31/10/2012	OHIM
DESIGN NUMBER	252695	
CLASS	14-02	
1)BROTHER INDUSTRIES LTD., A CORPORATION ORGANIZED AND EXISTING UNDER THE LAWS OF JAPAN, 15-1, NAESHIRO-CHO, MIZUHO-KU, NAGOYA-SHI, AICHI-KEN, JAPAN		
DATE OF REGISTRATION	28/03/2013	
TITLE	PHOTOSENSITIVE DRUM UNIT	
PRIORITY		
PRIORITY NUMBER	DATE	COUNTRY
2012-028323	20/11/2012	JAPAN

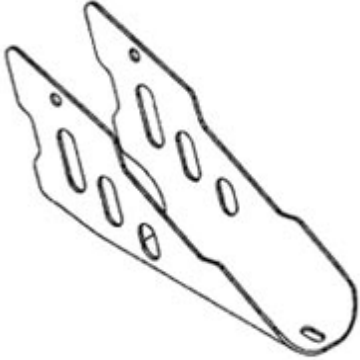







DESIGN NUMBER	252900		
CLASS	14-02		
1) TREK TECHNOLOGY (SINGAPORE) PTE LTD, A COMPANY ORGANISED AND EXISTING UNDER THE LAWS OF SINGAPORE, OF 30 LOYANG WAY #07-13/14/15, LOYANG INDUSTRIAL ESTATE, SINGAPORE 508769			
DATE OF REGISTRATION	04/04/2013		
TITLE	PEN DRIVE		
PRIORITY			
PRIORITY NUMBER	DATE	COUNTRY	
D2012/1224/Z	17/10/2012	SINGAPORE	
DESIGN NUMBER	249312		
CLASS	08-06		
1) K. & K. IMPLIMENTS PVT. LTD. (A INCORPORATE UNDER THE COMPANIES ACT. 1956), WHOSE REGISTERED OFFICE AT G-1910, J-ROAD, B/H. GUJARAT GAS GODOWN, ALMIGHTY GATE, G.I.D.C., METODA, KALAWAD ROAD, RAJKOT, GUJARAT, INDIA			
DATE OF REGISTRATION	08/11/2012		
TITLE	HANDLE		
PRIORITY NA			
DESIGN NUMBER	250540		
CLASS	12-11		
1) LA BICYCLE (THAILAND) CO. LTD., A COMPANY INCORPORATED UNDER THE LAWS OF THAILAND, 58 MOO 2, TAMBOL OAM-YAI, AMPHUR SAMPRAN, NAKORNPATHOM PROVINCE 73160, THAILAND			
DATE OF REGISTRATION	31/12/2012		
TITLE	TOP GUSSET OF BICYCLE		
PRIORITY NA			



DESIGN NUMBER	250551	
CLASS	23-03	
1)M/S V-GUARD INDUSTRIES LTD., AN INDIAN COMPANY INCORPORATED UNDER THE COMPANIES ACT OF 1956 WHOSE ADDRESS IS 33/2905 F, VENNALA HIGH SCHOOL ROAD, VENNALA, KOCHI-682028, KERALA STATE, INDIA		
DATE OF REGISTRATION	31/12/2012	
TITLE	WATER HEATERS	
PRIORITY NA		

DESIGN NUMBER	253161	
CLASS	08-03	
1)(1)PRAKASH H. RAKHOLIA (2)SHILPA P. RAKHOLIA AND (3)BHARAT C. KOTADIA ALL INDIAN NATIONAL PARTNER OF DHARMAJ TECHNOLOGIES AN INDIAN PARTNERSHIP FIRM HAVING ITS PRINCIPAL PLACE OF BUSINESS AT ADDRESS: 28, SAHAJANAND BHUVAN, MALI NI WADI, A.K. ROAD, SURAT-395008, GUJARAT-INDIA		
DATE OF REGISTRATION	15/04/2013	
TITLE	LASER DIAMOND SAWING AND CUTTING MACHINE	
PRIORITY NA		

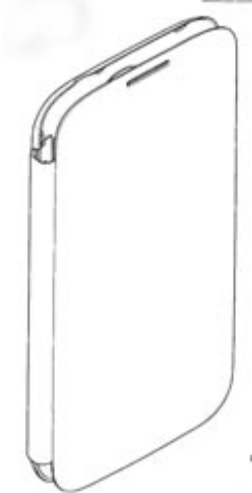
DESIGN NUMBER	253919	
CLASS	23-02	
1)HALLMARK CREATIONS PRIVATE LIMITED (A COMPANY INCORPORATED UNDER THE COMPANIES ACT, 1956) HAVING ITS PRINCIPAL PLACE OF BUSINESS AT PLOT NO. 7/8, SURVEY NO. 20, EVEREST INDUSTRIAL AREA, NEAR PERFECT (TATA) SHOWROOM, NATIONAL HIGHWAY NO. 8, VAVDI-DIST. RAJKOT-360001, GUJARAT-INDIA		
DATE OF REGISTRATION	17/05/2013	
TITLE	SOAP DISH	
PRIORITY NA		

DESIGN NUMBER	254027		
CLASS	10-07		
1)BREITLING SA, A CORPORATION ORGANIZED AND EXISTING UNDER THE LAWS OF SWITZERLAND, OF SCHLACHTHAUSTRASSE 2, 2540 GRENCHE, SWITZERLAND			
DATE OF REGISTRATION	22/05/2013		
TITLE	WATCH CASE WITH DIAL		
PRIORITY			
PRIORITY NUMBER	DATE	COUNTRY	
731389601	10/04/2013	WIPO	
DESIGN NUMBER	252992		
CLASS	07-05		
1)KONINKLIJKE PHILIPS ELECTRONICS N.V., A COMPANY ORGANIZED AND EXISTING UNDER THE LAWS OF THE KINGDOM OF THE NETHERLANDS, RESIDING AT EINDHOVEN, WHOSE POST-OFFICE ADDRESS IS HIGH TECH CAMPUS 5, 5656 AE EINDHOVEN, THE NETHERLANDS			
DATE OF REGISTRATION	10/04/2013		
TITLE	IRON WITH STEAM GENERATOR		
PRIORITY			
PRIORITY NUMBER	DATE	COUNTRY	
002117341-0003	11/10/2012	OHIM	
DESIGN NUMBER	254075		
CLASS	23-01		
1)IDROMECCANICA ROSSI S.N.C. DI ROSSI C. & C. VIA ENRICO FERMI, 29 42123 FOGLIANO (RE) ITALY A COMPANY OF ITALY			
DATE OF REGISTRATION	24/05/2013		
TITLE	WATER SPRINKLERS		
PRIORITY			
PRIORITY NUMBER	DATE	COUNTRY	
002142513-0002	26/11/2012	OHIM	

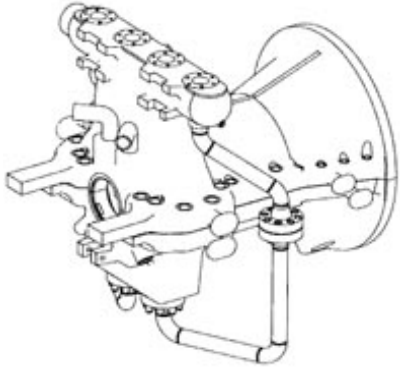

DESIGN NUMBER	254130		
CLASS	07-06		
1) NATIONAL INSTITUTE OF DESIGN LOCATED AT PALDI, AHMEDABAD-380007, GUJARAT, HAVING NATIONALITY AS INDIAN			
DATE OF REGISTRATION	28/05/2013		
TITLE	BOTTLE OPENER		
PRIORITY NA			
DESIGN NUMBER	254205		
CLASS	14-99		
1) SAMSUNG ELECTRONICS CO., LTD. 129, SAMSUNG-RO, YEONGTONG-GU, SUWON-SI, GYEONGGI-DO, 443-742, REPUBLIC OF KOREA, A COMPANY OF REPUBLIC OF KOREA			
DATE OF REGISTRATION	30/05/2013		
TITLE	CASE FOR ELECTRONIC DEVICE		
PRIORITY			
PRIORITY NUMBER	DATE	COUNTRY	
30-2013-0012857	13/03/2013	REPUBLIC OF KOREA	
DESIGN NUMBER	254235		
CLASS	06-07		
1) MA DESIGN INDIA PRIVATE LIMITED, A COMPANY INCORPORATED IN INDIA HAVING ITS PRINCIPAL PLACE OF BUSINESS AT A-41, SECTOR-80, PHASE-II, NOIDA-201305, U.P. INDIA			
DATE OF REGISTRATION	03/06/2013		
TITLE	PHOTO FRAME		
PRIORITY NA			

DESIGN NUMBER	252508	
CLASS	13-03	
1)CROMPTON GREAVES LIMITED, (AN INDIAN COMPANY), AVANTHA HOUSE, 6TH FLOOR, DR. ANNIE BESANT ROAD, WORLI, MUMBAI-400030, MAHARASHTRA, INDIA		
DATE OF REGISTRATION	20/03/2013	
TITLE	SELF POWERED PROTECTIVE RELAY	
PRIORITY NA		
DESIGN NUMBER	252619	
CLASS	15-04	
1)GURJIWAN AGRO INDUSTRIES OF V.P.O. HARRAIPUR, TEHSIL-BATHINDA, DISTT. BATHINDA-151201 (PUNJAB), INDIA, AN INDIAN PROPRIETORSHIP FIRM WHOSE PROPRIETORSHIP FIRM WHOSE PROPRIETOR IS S. ATMA SINGH, INDIAN NATIONAL OF ABOVE ADDRESS		
DATE OF REGISTRATION	22/03/2013	
TITLE	ROAD LEVELLER	
PRIORITY NA		
DESIGN NUMBER	254685	
CLASS	15-01	
1)TRIVENI TURBINE LIMITED, AN INDIAN COMPANY HAVING ITS PLACE OF BUSINESS AT 12A, PEENYA INDUSTRIAL AREA, BANGLORE-560058		
DATE OF REGISTRATION	24/06/2013	
TITLE	STEAM CASING OF A STEAM TURBINE	
PRIORITY NA		

DESIGN NUMBER	252130	
CLASS	08-07	
1)MR. C. P. SHARMA (AN INDIAN NATIONAL) M/S. PAWAN ENGINEERS, 2/277, BEGUM BAGH, ALIGARH-202001 (U.P.)		
DATE OF REGISTRATION	06/03/2013	
TITLE	INTERLOCK	
PRIORITY NA		

DESIGN NUMBER	252170	
CLASS	12-08	
1)DR. ING. H.C.F. PORSCHE AKTIENGESELLSCHAFT, A GERMAN COMPANY OF PORSCHEPLATZ 1, 70435 STUTTGART, GERMANY		
DATE OF REGISTRATION	07/03/2013	
TITLE	CAR	
PRIORITY NA		

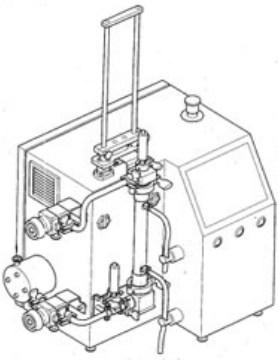
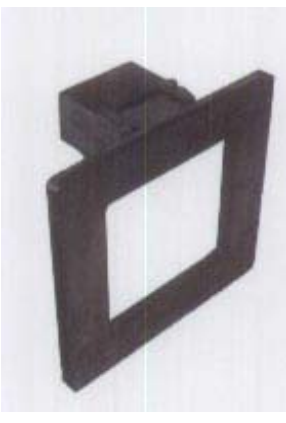
DESIGN NUMBER	253474		
CLASS	15-01		
1)HONDA MOTOR CO., LTD., A CORPORATION OF JAPAN OF 1-1, MINAMI-AOYAMA 2-CHOME, MINATO-KU, TOKYO, 107-8556 JAPAN.			
DATE OF REGISTRATION	26/04/2013		
TITLE	AIR CLEANER COVER FOR INTERNAL COMBUSTION ENGINES		
PRIORITY			
PRIORITY NUMBER	DATE	COUNTRY	
2012-026216	29/10/2012	JAPAN	

DESIGN NUMBER	253574		
CLASS	24-01		
1)GE HEALTHCARE BIO-SCIENCES AB, BJÖRKGATAN 30, SE-751 84 UPPSALA, SWEDEN			
DATE OF REGISTRATION	30/04/2013		
TITLE	BENCH TOP CROSS FLOW FILTRATION SYSTEM		
PRIORITY			
PRIORITY NUMBER	DATE	COUNTRY	
201230540678.0	08/11/2012	CHINA	
DESIGN NUMBER	254881		
CLASS	08-06		
1)AMITBHAI SHANTILAL RAKHOLIYA AN INDIAN NATIONAL SOLE PROPRIETOR OF STAR-TECH INDUSTRIES AN INDIAN PROPRIETORSHIP FIRM HAVING ITS PRINCIPAL PLACE OF BUSINESS AT ADDRESS: 3, GOKUL NAGAR, 1ST FLOOR, OPP. AMAN PAN, NEAR 50 FEET MAIN ROAD, KOTHARIYA ROAD, RAJKOT-2, GUJARAT-INDIA			
DATE OF REGISTRATION	28/06/2013		
TITLE	KNOB		
PRIORITY NA			
DESIGN NUMBER	249107		
CLASS	13-99		
1)M/S. RAPID ELECTRODE PVT. LTD, (A REGISTERED INDIAN COMPANY INCORPORATED UNDER INDIAN COMPANIES ACT, 1956) OF 104, GHAYEL COMPOUND, NR. BRC TEMPLE, UDHANA, SURAT-394210 (GUJARAT), INDIA			
DATE OF REGISTRATION	31/10/2012		
TITLE	ELECTRICAL EARTHROD		
PRIORITY NA			

DESIGN NUMBER	254554		
CLASS	16-06		
1)ELECTROLAB (INDIA) PVT. LTD. (AN INDIAN PRIVATE LIMITED COMPANY REGISTERED UNDER THE INDIAN COMPANIES ACT, 1956), OF 401, TIRUPATI UDYOG, I. B. PATEL ROAD, OFF. WESTERN EXTRESS HIGHWAY, GOREGAON (EAST), MUMBAI-400063, MAHARASHTRA, INDIA.			
DATE OF REGISTRATION	18/06/2013		
TITLE	MICROSCOPE		
PRIORITY NA			
DESIGN NUMBER	252716		
CLASS	12-16		
1)HYVA HOLDING B.V. OF THE ADDRESS ONDERNEMINGSWEG 1, NL-2404 HM ALPHEN AAN DEN RIJN, THE NETHERLANDS			
DATE OF REGISTRATION	28/03/2013		
TITLE	OIL TANK		
PRIORITY			
PRIORITY NUMBER	DATE	COUNTRY	
002209940	27/03/2013	OHIM	
DESIGN NUMBER	252750		
CLASS	08-06		
1)PADMA TRADERS., (AN INDIAN SOLE PROPRIETORSHIP CONCERN), HAVING OFFICE AT ROOM NO. 4, SURESH TIWARI CHAWL, B/H WELCOME PLYWOOD, 3RD CARTER ROAD, BORIVALI (EAST), MUMBAI-400066, MAHARASHTRA, INDIA. WHOSE PROPRIETOR IS VIKAS JAIN. (INDIAN NATIONAL) OF ABOVE ADDRESS			
DATE OF REGISTRATION	02/04/2013		
TITLE	HANDLE		
PRIORITY NA			

DESIGN NUMBER	249692	
CLASS	09-03	
1)DONGGUAN TR BEARING CO., LTD. (A COMPANY INCORPORATED AND EXISTING UNDER THE LAWS OF CHINA) WHOSE OFFICE IS AT NO. 27, GUANTAI ROAD, GUANCHENG DISTRICT, DONGGUAN CITY, CHINA		
DATE OF REGISTRATION	26/11/2012	
TITLE	PACKING BOX	
PRIORITY NA		
DESIGN NUMBER	252975	
CLASS	28-03	
1)B. R. PLASTICS, AN INDIAN PARTNERSHIP FIRM, WHOSE OFFICE AT 59, 3RD BHOIWADA, BHULESHWAR, MUMBAI-400002, MAHARASHTRA, INDIA AND FACTORY AT 314, A TO Z INDUSTRIAL ESTATE, 3RD FLOOR, G. KADAM MARG, MUMBAI-400013, MAHARASHTRA, INDIA, WHOSE PARTNERS ARE SURENDRA RAMANLAL SHAH, RAJESH RAMANLAL SHAH, UDAY RAMANLAL SHAH AND PARAG SURENDRA SHAH, ALL INDIANS AND ALL BEING PARTNERS AND OF ABOVE ADDRESS		
DATE OF REGISTRATION	09/04/2013	
TITLE	COMB	
PRIORITY NA		
DESIGN NUMBER	254254	
CLASS	23-02	
1)KLAUS WAREN FIXTURES PVT. LTD. OF 285, "PARK VIEW 1ST FLOOR, FLAT NO. 9, B. A. K. ANJAN MARG, OPP. NAPOO GARDEN, MATUNGA (CENTRAL RAILWAY) (E), MUMBAI-400019, MAHARASHTRA, INDIA, INDIAN COMPANY		
DATE OF REGISTRATION	03/06/2013	
TITLE	OVER HEAD SHOWER	
PRIORITY NA		

DESIGN NUMBER	252505	
CLASS	13-03	
1)CROMPTON GREAVES LIMITED, (AN INDIAN COMPANY), AVANTHA HOUSE, 6TH FLOOR, DR. ANNIE BESANT ROAD, WORLI, MUMBAI-400030, MAHARASHTRA, INDIA		
DATE OF REGISTRATION	20/03/2013	
TITLE	SELF POWERED PROTECTIVE RELAY	
PRIORITY NA		
DESIGN NUMBER	252636	
CLASS	08-06	
1)BHARATBHAI BHURABHAI DOMADIA AND KALPESHBHAI VELJIBHAI DOMADIA BOTH INDIAN NATIONAL PARTNERS OF APEX TECHNO CAST AN INDIAN PARTNERSHIP FIRM HAVING ITS PRINCIPAL PLACE OF BUSINESS AT 5, AJI VASAHA, OPP. WESTERN MINERAL, 80 FEET ROAD, RAJKOT, GUJARAT-INDIA		
DATE OF REGISTRATION	25/03/2013	
TITLE	HANDLE	
PRIORITY NA		
DESIGN NUMBER	254679	
CLASS	09-03	
1)BCH ELECTRIC LIMITED, AN INDIAN CORPORATION, HAVING ITS CORPORATE OFFICE AT THE ADDRESS 1105, NEW DELHI HOUSE, 27, BARAKHAMBA ROAD, NEW DELHI-110001		
DATE OF REGISTRATION	24/06/2013	
TITLE	PACKAGING CARTON	
PRIORITY NA		

DESIGN NUMBER	253571	
CLASS	02-02	
1)SWASTIKA GARMENTS, 4, RAMKUMAR RAKSHIT LANE, KOLKATA-700007, WEST BENGAL, INDIA, AN INDIAN PROPRIETORSHIP FIRM WHOSE PROPRIETOR IS BRIJ GOPAL MUNDHARA, AN INDIAN OF THE ABOVE ADDRESS		
DATE OF REGISTRATION	30/04/2013	
TITLE	GARMENT	
PRIORITY NA		
DESIGN NUMBER	253594	
CLASS	12-16	
1)RCJ AUTO FORGE PVT LTD., E-756-757, PHASE-VII, FOCAL POINT, LUDHIANA-141010 (PUNJAB) INDIA (AN INDIAN COMPANY DULY REGISTERED UNDER THE COMPANIES ACT, 1956) OF THE ABOVE ADDRESS		
DATE OF REGISTRATION	01/05/2013	
TITLE	DASH-BOARD FOR AUTO RICKSHAW	
PRIORITY NA		
DESIGN NUMBER	254876	
CLASS	08-06	
1)RAJESHBHAI TULSHIBHAI KIYADA AN INDIAN NATIONAL SOLE PROPRIETOR OF NATRAJ TECHNOCAST AN INDIAN PROPRIETORSHIP FIRM HAVING ITS PRINCIPAL PLACE OF BUSINESS AT NEAR POLYTECHNIC HOSTEL, B/H K. S. DIESEL, 12-AJI VASAHAAT, RAJKOT-360 003, GUJARAT-INDIA.		
DATE OF REGISTRATION	28/06/2013	
TITLE	HANDLE	
PRIORITY NA		



DESIGN NUMBER	254990	
CLASS	15-02	
1)WEIR MINERALS INDIA-ENSCI. CO, A/01/02, PLATINUM CITY, HMT ROAD, YESHWANTPUR, BANGALORE-560022, KARNATAKA, NATIONALITY-INDIAN		
DATE OF REGISTRATION	04/07/2013	
TITLE	DRY SALT PUMP	
PRIORITY NA		
DESIGN NUMBER	252690	
CLASS	99-00	
1)PARAG PRAVIN KENIA. (INDIAN NATIONAL) OF 701, TULIP SAINATH GARDEN, TATA COLONY, NAVGARH ROAD, MULUND (EAST), MUMBAI-400081, MAHARASHTRA, INDIA		
DATE OF REGISTRATION	26/03/2013	
TITLE	COMB FOR PAPER CRAFTING	
PRIORITY NA		
DESIGN NUMBER	252887	
CLASS	05-05	
1)PARRY MURRAY & CO. LTD., COMPANY REGISTERED UNDER THE LAWS OF ENGLAND AND WALES, HAVING ITS PRINCIPAL PLACE OF BUSINESS AT 3RD FLOOR, SIMPSON HOUSE, 6 CHERRY ORCHARD ROAD, CROYDON, CRO 6BA, UNITED KINGDOM		
DATE OF REGISTRATION	04/04/2013	
TITLE	TEXTILE FABRIC	
PRIORITY NA		

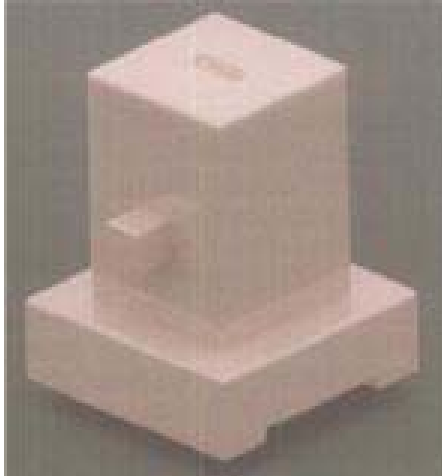

DESIGN NUMBER	250550		
CLASS	23-03		
1)M/S V-GUARD INDUSTRIES LTD., AN INDIAN COMPANY INCORPORATED UNDER THE COMPANIES ACT OF 1956 WHOSE ADDRESS IS 33/2905 F, VENNALA HIGH SCHOOL ROAD, VENNALA, KOCHI-682028, KERALA STATE, INDIA			
DATE OF REGISTRATION	31/12/2012		
TITLE	WATER HEATERS		
PRIORITY NA			
DESIGN NUMBER	253147		
CLASS	09-05		
1)WM. WRIGLEY JR. COMPANY, AN AMERICAN COMPANY OF 410 NORTH MICHIGAN AVENUE, CHICAGO, ILLINOIS 60611, USA			
DATE OF REGISTRATION	12/04/2013		
TITLE	SLEEVE FOR BLISTER PACKAGING		
PRIORITY			
PRIORITY NUMBER	DATE	COUNTRY	
29/434591	15/10/2012	U.S.A.	
PRIORITY NA			
DESIGN NUMBER	253197		
CLASS	16-05		
1)SRUJAN JOSHI, 5-3/1/173, AVR COLONY, BODUPPAL, HYDERABAD-500092, ANDHRA PRADESH, INDIA, AN INDIAN NATIONAL			
DATE OF REGISTRATION	17/04/2013		
TITLE	CAMERA		
PRIORITY NA			

DESIGN NUMBER	253379	
CLASS	09-02	
1)PRABH DAYAL OM PARKASH INFRASTRUCTURE PVT. LTD., AN INDIAN COMPANY DULY INCORPORATED UNDER THE COMPANIES ACT, 1956, WITH LIMITED LIABILITY, HAVING ITS REGISTERED OFFICE AT 2880, SIRKIWALAN, HAUZ QAZI, DELHI-110006, INDIA		
DATE OF REGISTRATION	25/04/2013	
TITLE	WATER STORAGE TANK	
PRIORITY NA		

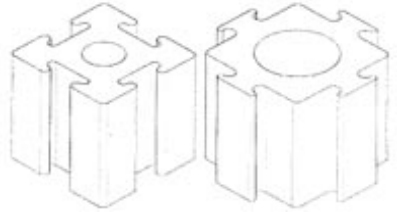
DESIGN NUMBER	254026	
CLASS	31-00	
1)MR. SUMEET CHAWLA (PROPRIETOR), NATIONALITY INDIAN TRADING AS POPULAR STEEL INDUSTRIES (INDIAN) WHOES ADDRESS IS PLOT NO-64, INDUSTRIAL AREA, PHASE-IX, S.A.S. NAGAR, MOHALI-160059 (INDIA)		
DATE OF REGISTRATION	22/05/2013	
TITLE	CHOPPING MACHINE	
PRIORITY NA		

DESIGN NUMBER	249701	
CLASS	31-00	
1)M/S V-GUARD INDUSTRIES LTD., AN INDIAN COMPANY INCORPORATED UNDER THE COMPANIES ACT OF 1956 WHOSE ADDRESS IS 33/2905 F, VENNALA HIGH SCHOOL ROAD, VENNALA, KOCHI-682028, KERALA STATE, INDIA		
DATE OF REGISTRATION	26/11/2012	
TITLE	MIXER	
PRIORITY NA		

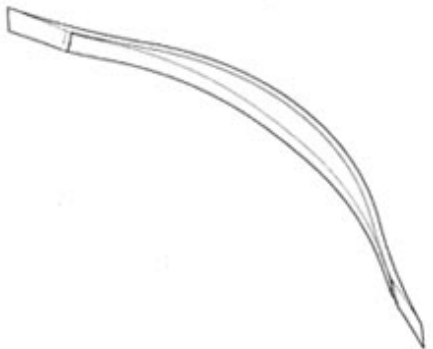
DESIGN NUMBER	252926		
CLASS	25-01		
1)MICHAEL LAZAR, A SINGAPORE CITIZEN WHOSE ADDRESS IS 214 MARSILING LANE, #24-806, SINGAPORE 730214			
DATE OF REGISTRATION	05/04/2013		
TITLE	EROSION CONTROL BLOCKS (SET)		
PRIORITY			
PRIORITY NUMBER	DATE	COUNTRY	
D2012/1207/H	09/10/2012	SINGAPORE	
DESIGN NUMBER	254074		
CLASS	23-01		
1)IDROMECCANICA ROSSI S.N.C. DI ROSSI C. & C. VIA ENRICO FERMI, 29 42123 FOGLIANO (RE) ITALY A COMPANY OF ITALY			
DATE OF REGISTRATION	24/05/2013		
TITLE	WATER SPRINKLERS		
PRIORITY			
PRIORITY NUMBER	DATE	COUNTRY	
002142513-0001	26/11/2012	OHIM	
DESIGN NUMBER	254105		
CLASS	08-06		
1)KAPILBHAI BALVANTRAI VYAS AND JIGNESHBHAI CHHAGANBHAI GOHEL BOTH INDIAN NATIONAL PARTNER OF RATNAPRABHA HARDWARE AN INDIAN PARTNERSHIP FIRM HAVING ITS PRINCIPAL PLACE OF BUSINESS AT ADDRESS:- 6, PARSANA SOCIETY, 50 FEET ROAD, KOTHARIYA MAIN ROAD, RAJKOT-2. GUJARAT-INDIA			
DATE OF REGISTRATION	27/05/2013		
TITLE	HANDLE		
PRIORITY NA			

DESIGN NUMBER	254233		
CLASS	07-03		
1)MA DESIGN INDIA PRIVATE LIMITED, A COMPANY INCORPORATED IN INDIA HAVING ITS PRINCIPAL PLACE OF BUSINESS AT A-41, SECTOR-80, PHASE-II, NOIDA-201305, U.P. INDIA			
DATE OF REGISTRATION	03/06/2013		
TITLE	CHEESE KNIFE		
PRIORITY NA			
DESIGN NUMBER	254262		
CLASS	14-99		
1)SAMSUNG ELECTRONICS CO., LTD. 129, SAMSUNG-RO, YEONGTONG-GU, SUWON-SI, GYEONGGI-DO, 443-742, REPUBLIC OF KOREA, A COMPANY OF REPUBLIC OF KOREA			
DATE OF REGISTRATION	04/06/2013		
TITLE	TELEVISION STAND		
PRIORITY			
PRIORITY NUMBER	DATE	COUNTRY	
30-2012-0059740	11/12/2012	REPUBLIC OF KOREA	
DESIGN NUMBER	252507		
CLASS	13-03		
1)CROMPTON GREAVES LIMITED, (AN INDIAN COMPANY), AVANTHA HOUSE, 6TH FLOOR, DR. ANNIE BESANT ROAD, WORLI, MUMBAI-400030, MAHARASHTRA, INDIA			
DATE OF REGISTRATION	20/03/2013		
TITLE	SELF POWERED PROTECTIVE RELAY		
PRIORITY NA			



DESIGN NUMBER	253818	
CLASS	23-04	
1)HITACHI APPLIANCES, INC., A CORPORATION DULY ORGANIZED AND EXISTING UNDER THE LAWS OF JAPAN OF 16-1, KAIGAN 1-CHOME, MINATO-KU, TOKYO, JAPAN		
DATE OF REGISTRATION	15/05/2013	
TITLE	CHILLER UNIT	
PRIORITY NA		
DESIGN NUMBER	254783	
CLASS	09-03	
1)MAPCO CORPORATION,, (AN INDIAN SOLE PROPRIETORSHIP CONCERN), HAVING OFFICE AT 39-C, MAHADEV INDUSTRIAL ESTATE, SURVEY NO. 3, HISSA NO. 1, GOTE GHAR MUMBRA PANVEL HIGHWAY, DAHISAR, NEW MUMBAL MAHARASHTRA, INDIA. WHOSE PROPRIETOR IS MOHAMMAD HAMID KHAN. (INDIAN NATIONAL) OF ABOVE ADDRESS		
DATE OF REGISTRATION	25/06/2013	
TITLE	CONTAINER	
PRIORITY NA		
DESIGN NUMBER	252011	
CLASS	08-06	
1)BHARATBHAI B. MUNGAPARA AN INDIAN NATIONAL SOLE PROPRIETOR OF MAHESH TIME INDUSTRIES AN INDIAN PROPRIETORSHIP FIRM HAVING ITS PRINCIPAL PLACE OF BUSINESS AT SHREE HARI INDUSTRIAL ZONE MAIN ROAD, PLOT NO. 68, AJI RING ROAD, RAJKOT, GUJARAT-INDIA		
DATE OF REGISTRATION	04/03/2013	
TITLE	HANDLE	
PRIORITY NA		

DESIGN NUMBER	253493	
CLASS	02-02	
1)KEWAL KIRAN CLOTHING LTD. OF KEWAL KIRAN ESTATE, 460/7 I.B.PATEL ROAD, NEAR TIRUPATI UDYOG, GOREGAON (EAST), MUMBAI-400063, MAHARASHTRA, INDIA, INDIAN COMPANY		
DATE OF REGISTRATION	29/04/2013	
TITLE	T-SHIRT WITH EARPHONE	
PRIORITY NA		

DESIGN NUMBER	254880	
CLASS	08-06	
1)AMITBHAI SHANTILAL RAKHOLIYA AN INDIAN NATIONAL SOLE PROPRIETOR OF STAR-TECH INDUSTRIES AN INDIAN PROPRIETORSHIP FIRM HAVING ITS PRINCIPAL PLACE OF BUSINESS AT ADDRESS: 3, GOKUL NAGAR, 1ST FLOOR, OPP. AMAN PAN, NEAR 50 FEET MAIN ROAD, KOTHARIYA ROAD, RAJKOT-2, GUJARAT-INDIA		
DATE OF REGISTRATION	28/06/2013	
TITLE	KNOB	
PRIORITY NA		

DESIGN NUMBER	250552	
CLASS	23-03	
1)M/S V-GUARD INDUSTRIES LTD., AN INDIAN COMPANY INCORPORATED UNDER THE COMPANIES ACT OF 1956 WHOSE ADDRESS IS 33/2905 F, VENNALA HIGH SCHOOL ROAD, VENNALA, KOCHI-682028, KERALA STATE, INDIA		
DATE OF REGISTRATION	31/12/2012	
TITLE	WATER HEATERS	
PRIORITY NA		

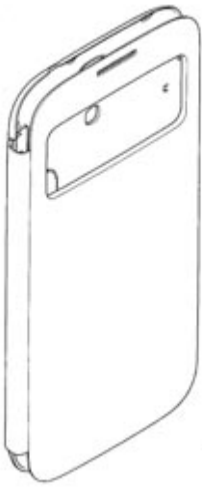
DESIGN NUMBER	251282		
CLASS	23-01		
1)TOYOX CO., LTD. 4371, MAEZAWA, KUROBE-SHI, TOYAMA-KEN, JAPAN, A JAPANESE COMPANY			
DATE OF REGISTRATION	29/01/2013		
TITLE	HOSE		
PRIORITY NA			
DESIGN NUMBER	253921		
CLASS	08-08		
1)(1) MEHULBHAI D. CHAVDA (2) SOMESHBHAI S. MALIK AND (3) DHIRENBHAI SHAH ALL INDIAN NATIONAL PARTNER OF DMS ARCHITECTURAL PRODUCTS AN INDIAN PARTNERSHIP FIRM HAVING ITS PRINCIPAL PLACE OF BUSINESS AT ADDRESS: PLOT NO. 6, SURVEY NO. 20, EVEREST INDUSTRIAL AREA, NEAR PERFECT (TATA) SHOWROOM, NATIONAL HIGHWAY NO. 8-B, VAVDI-DIST. RAJKOT-360004, GUJARAT-INDIA.			
DATE OF REGISTRATION	17/05/2013		
TITLE	CURTAIN BRACKET		
PRIORITY NA			
DESIGN NUMBER	252993		
CLASS	07-05		
1)KONINKLIJKE PHILIPS ELECTRONICS N.V., A COMPANY ORGANIZED AND EXISTING UNDER THE LAWS OF THE KINGDOM OF THE NETHERLANDS, RESIDING AT EINDHOVEN, WHOSE POST-OFFICE ADDRESS IS HIGH TECH CAMPUS 5, 5656 AE EINDHOVEN, THE NETHERLANDS			
DATE OF REGISTRATION	10/04/2013		
TITLE	STEAM GENERATOR FOR IRON		
PRIORITY			
PRIORITY NUMBER	DATE	COUNTRY	
002117341-0002	11/10/2012	OHIM	

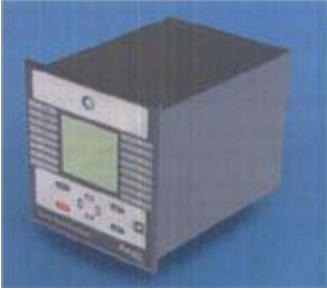

DESIGN NUMBER	254206		
CLASS	14-99		
1)SAMSUNG ELECTRONICS CO., LTD. 129, SAMSUNG-RO, YEONGTONG-GU, SUWON-SI, GYEONGGI-DO, 443-742, REPUBLIC OF KOREA, A COMPANY OF REPUBLIC OF KOREA			
DATE OF REGISTRATION	30/05/2013		
TITLE	CASE FOR ELECTRONIC DEVICE		
PRIORITY			
PRIORITY NUMBER	DATE	COUNTRY	
30-2013-0012860	13/03/2013	REPUBLIC OF KOREA	
PRIORITY NA			
PRIORITY NA			
DESIGN NUMBER	252457		
CLASS	13-03		
1)CROMPTON GREAVES LIMITED, (AN INDIAN COMPANY), AVANTHA HOUSE, 6TH FLOOR, DR. ANNIE BESANT ROAD, WORLI, MUMBAI- 400030, MAHARASHTRA, INDIA			
DATE OF REGISTRATION	20/03/2013		
TITLE	CURRENT TRANSFORMER		
PRIORITY NA			
DESIGN NUMBER	252515		
CLASS	13-03		
1)CROMPTON GREAVES LIMITED, (AN INDIAN COMPANY), AVANTHA HOUSE, 6TH FLOOR, DR. ANNIE BESANT ROAD, WORLI, MUMBAI- 400030, MAHARASHTRA, INDIA			
DATE OF REGISTRATION	20/03/2013		
TITLE	SELF POWERED PROTECTIVE RELAY		
PRIORITY NA			

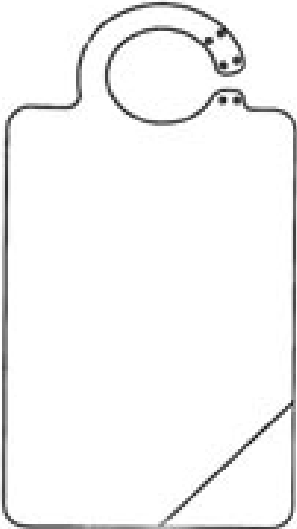

DESIGN NUMBER	251897		
CLASS	07-07		
1)NAYASA WORLD OF SURVEY NO. 655/1C NEAR SOMNANATH CO.OP.SOCIETY, DABHEL NANI DAMAN, DAMAN-396310, (UNION TERRITORIES) DAMAN, INDIA, INDIAN PARTNERSHIP FIRM, WHOSE PARTNERS ARE RUPA SACHDEV, MANASI SACHDEV & KISHOR MALIK, ALL INDIAN NATIONALS			
DATE OF REGISTRATION	27/02/2013		
TITLE	TIFFIN BOX		
PRIORITY NA			
DESIGN NUMBER	254656		
CLASS	12-16		
1)SCANIA CV AB, A SWEDISH COMPANY OF, SE-151 87, SÖDERTÄLJE, SWEDEN			
DATE OF REGISTRATION	21/06/2013		
TITLE	UPPER FRONT PANEL FOR VEHICLES		
PRIORITY			
PRIORITY NUMBER	DATE	COUNTRY	
201330035714.2	31/01/2013	CHINA	
DESIGN NUMBER	250900		
CLASS	12-99		
1)GHELABHAI GOKALBHAI BHAKHAR, (AN INDIVIDUAL- AN INDIAN RESIDENT) OF C/O. 1, 2, 3, GREEN PARK, SURAT-NAVSARI MAIN ROAD, UNN, NR. ASHIRWAD HOTEL, SURAT-394210 (GUJARAT), INDIA			
DATE OF REGISTRATION	09/01/2013		
TITLE	FUEL SAVER KIT FOR VEHICLES		
PRIORITY NA			

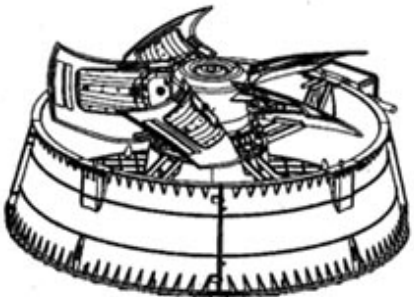

DESIGN NUMBER	252029	
CLASS	06-13	
1)KIDDY KLOBBER LIMITED, A COMPANY DULY ORGANIZED AND EXISTING UNDER THE LAWS OF ENGLAND OF RADLET FARM, RADLET, NR. NETHER STOWEY, SOMERSET, TA5 1JA, UNITED KINGDOM		
DATE OF REGISTRATION	04/03/2013	
TITLE	APRON TOWEL	
PRIORITY NA		

DESIGN NUMBER	252171	
CLASS	21-01	
1)DR. ING. H.C.F. PORSCHE AKTIENGESELLSCHAFT, A GERMAN COMPANY OF PORSCHEPLATZ 1, 70435 STUTTGART, GERMANY		
DATE OF REGISTRATION	07/03/2013	
TITLE	TOY CAR	
PRIORITY NA		

DESIGN NUMBER	252744	
CLASS	08-06	
1)RAJESHBHAI SAMBHUBHAI KOTADIYA (INDIAN NATIONALS) SOLE PROPRIETOR OF PIONEER METAL (INDIAN PROPRIETORSHIP CONCERN) HAVING PLACE OF BUSINESS AT-1/8, RAMNAGAR, 80, FEET ROAD, B/H. K. RASHIKLAL, RAJKOT-360003 GUJARAT (INDIA)		
DATE OF REGISTRATION	02/04/2013	
TITLE	HANDLE	
PRIORITY NA		

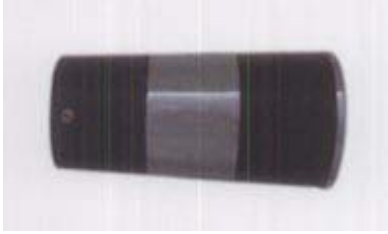
DESIGN NUMBER	252765		
CLASS	23-04		
1)PACOLINE INDUSTRIES PVT. LTD., A COMPANY INCORPORATED UNDER THE INDIAN COMPANIES ACT, AT 21/1, HADAPSAR INDUSTRIAL ESTATE, HADAPSAR, PUNE-411013, MAHARASHTRA, INDIA			
DATE OF REGISTRATION	02/04/2013		
TITLE	VENTILATOR		
PRIORITY NA			
DESIGN NUMBER	252778		
CLASS	12-08		
1)MR. KRISHNA VISHWAKARMA, MR. OMVIR CHAURASIA, MR. RAHUL SRIVASTAVA HAVING ADDRESS AT CHANDRA HOSPITAL, VILLAGE PIPARI, POST-BAGHAGHADA, DISTT. GORAKHPUR, THANA-BELIPAR, UTTAR PRADESH-273401, INDIA			
DATE OF REGISTRATION	02/04/2013		
TITLE	CAR		
PRIORITY NA			
DESIGN NUMBER	252847		
CLASS	23-04		
1)EBM-PAPST MULFINGEN GMBH & CO. KG, OF BACHMÜHLE 2, 74673 MULFINGEN, GERMANY, A GERMAN COMPANY			
DATE OF REGISTRATION	03/04/2013		
TITLE	EXHAUST FAN		
PRIORITY			
PRIORITY NUMBER	DATE	COUNTRY	
002117408	11/10/2012	OHIM	

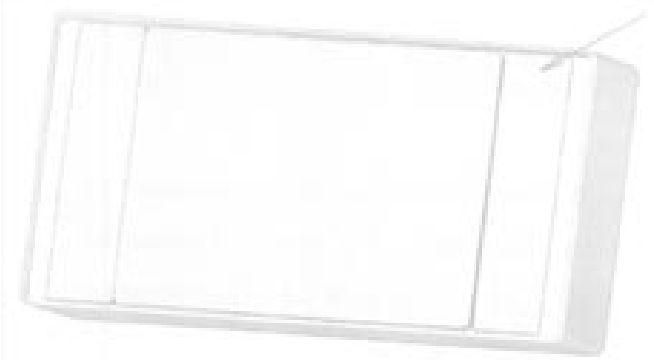

DESIGN NUMBER	250546	
CLASS	23-03	
1)M/S V-GUARD INDUSTRIES LTD., AN INDIAN COMPANY INCORPORATED UNDER THE COMPANIES ACT OF 1956 WHOSE ADDRESS IS 33/2905 F, VENNALA HIGH SCHOOL ROAD, VENNALA, KOCHI-682028, KERALA STATE, INDIA		
DATE OF REGISTRATION	31/12/2012	
TITLE	WATER HEATERS	
PRIORITY NA		
DESIGN NUMBER	253909	
CLASS	09-01	
1)EZLEMON FOOD TECHNOLOGIES PVT. LTD., A COMPANY INCORPORATED UNDER THE COMPANIES ACT, 1956 HAVING ITS ADDRESS AT E-11, CHIKHALTHANA M.I.D.C., AURANGABAD, 431310, MAHARASHTRA, INDIA, OF ABOVE ADDRESS		
DATE OF REGISTRATION	17/05/2013	
TITLE	BOTTLE	
PRIORITY NA		
DESIGN NUMBER	253925	
CLASS	08-08	
1)(1) MEHULBHAI D. CHAVDA (2) SOMESHBHAI S. MALIK AND (3) DHIRENBHAI SHAH ALL INDIAN NATIONAL PARTNER OF DMS ARCHITECTURAL PRODUCTS AN INDIAN PARTNERSHIP FIRM HAVING ITS PRINCIPAL PLACE OF BUSINESS AT ADDRESS: PLOT NO. 6, SURVEY NO. 20, EVEREST INDUSTRIAL AREA, NEAR PERFECT (TATA) SHOWROOM, NATIONAL HIGHWAY NO. 8-B, VAVDI-DIST. RAJKOT-360004, GUJARAT-INDIA		
DATE OF REGISTRATION	17/05/2013	
TITLE	CURTAIN BRACKET	
PRIORITY NA		

DESIGN NUMBER	253961		
CLASS	09-07		
1)PEARL POLYMERS LIMITED, OF 204, ROHIT HOUSE, 3, TOLSTOY MARG, NEW DELHI-110 001, INDIA, A COMPANY INCORPORATED UNDER THE COMPANIES ACT, 1956, OF THE ABOVE ADDRESS			
DATE OF REGISTRATION	17/05/2013		
TITLE	CAP OF BOTTLE		
PRIORITY NA			
DESIGN NUMBER	254036		
CLASS	08-06		
1)RAJESHBHAI GORDHANBHAI RAMANI (ADULT & INDIAN NATIONAL) SOLE PROPRIETOR OF SHREE INDUSTRIES (INDIAN PROPRIETORSHIP CONCERN) HAVING PLACE OF BUSINESS AT: 2, PARSANA SOCIETY, 50 FEET ROAD, RAJKOT-GUJARAT (INDIA)			
DATE OF REGISTRATION	23/05/2013		
TITLE	HANDLE		
PRIORITY NA			
DESIGN NUMBER	252909		
CLASS	12-16		
1)SCANIA CV AB, SE-151 87, SÖDERTÄLJE, SWEDEN			
DATE OF REGISTRATION	05/04/2013		
TITLE	CAB CORNER PANEL FOR VEHICLE		
PRIORITY			
PRIORITY NUMBER	DATE	COUNTRY	
2012/0447	10/10/2012	SWEDEN	

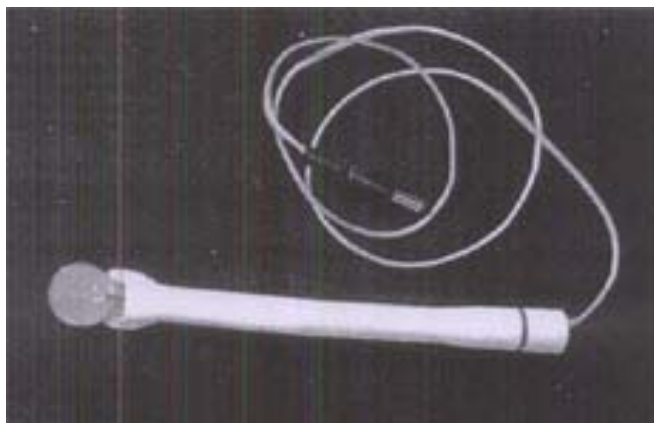
DESIGN NUMBER	254095	
CLASS	23-04	
1)DAIKIN INDUSTRIES LTD. A JAPANESE COMPANY OF THE ADDRESS: UMEDA CENTER BUILDING, 4-12 NAKAZAKI-NISHI 2-CHOME, KITA-KU, OSAKA-SHI, OSAKA-FU, JAPAN		
DATE OF REGISTRATION	27/05/2013	
TITLE	AIR CONDITIONER	
PRIORITY NA		

DESIGN NUMBER	254148	
CLASS	24-02	
1)SOLANKI GAURAV AND SOLANKI RENU C/O LATE SH. RAJENDRA SINGH SOLANKI, BARLON KA CHOWK, JODHPUR-342002 (RAJASTHAN).		
DATE OF REGISTRATION	29/05/2013	
TITLE	DENTAL SUCTION TIP	
PRIORITY NA		

DESIGN NUMBER	254238	
CLASS	09-07	
1)MA DESIGN INDIA PRIVATE LIMITED, A COMPANY INCORPORATED IN INDIA HAVING ITS PRINCIPAL PLACE OF BUSINESS AT A-41, SECTOR-80, PHASE-II, NOIDA-201305, U.P. INDIA		
DATE OF REGISTRATION	03/06/2013	
TITLE	STOPPER FOR BOTTLE	
PRIORITY NA		

DESIGN NUMBER	251854		
CLASS	12-16		
1)MAN TRUCK & BUS AG, A GERMAN COMPANY OF DACHAUER STR. 667, 80995 MÜNICH, GERMANY			
DATE OF REGISTRATION	25/02/2013		
TITLE	DRIVER S CAB OF A UTILITY VEHICLE		
PRIORITY			
PRIORITY NUMBER	DATE	COUNTRY	
002095620	28/08/2012	OHIM	
DESIGN NUMBER	254773		
CLASS	15-03		
1)M/S. F. C. INDUSTRIES, BATHINDA ROAD, NEAR D. A. V SCHOOL, JAITU-151202, DISTT. FARIDKOT (PUNJAB) INDIA AN INDIAN PROPRIETORSHIP FIRM WHOSE PROPRIETOR IS:- VISHAL KUMAR BEING INDIAN NATIONALS OF THE ABOVE ADDRESS			
DATE OF REGISTRATION	25/06/2013		
TITLE	CHUFF CUTTING MACHINE		
PRIORITY NA			
DESIGN NUMBER	252180		
CLASS	21-01		
1)PLAYTONE PRODUCTS, F-4, GALI NO. 33, MAHENDRA PARK, DELHI-110033, INDIA. (AN INDIAN PROPRIETORSHIP FIRM WHOSE PROPRIETOR IS :- SH. MANJEET LAL SEHGAL. AN INDIAN NATIONAL OF THE ABOVE ADDRESS			
DATE OF REGISTRATION	07/03/2013		
TITLE	TOY		
PRIORITY NA			

DESIGN NUMBER	253441		
CLASS	13-02		
1)MANIKA MOULDS PVT. LTD., A COMPANY INCORPORATED UNDER THE INDIAN COMPANIES ACT, AAR-PEE CENTRE, 601-605, 6TH FLOOR GUFFIC COMPOUND, MIDC, ANDHERI (E), MUMBAI-400093, MAHARASHTRA, INDIA			
DATE OF REGISTRATION	26/04/2013		
TITLE	BATTERY LID		
PRIORITY NA			
DESIGN NUMBER	253581		
CLASS	24-02		
1)SANTEN PHARMACEUTICAL CO., LTD., OF 9-19, SHIMOSHINJO 3-CHOME, HIGASHIYODOGAWA-KU, OSAKA-SHI, OSAKA 5338651, JAPAN			
DATE OF REGISTRATION	30/04/2013		
TITLE	INTRAOCULAR LENS IMPLANTATION DEVICE		
PRIORITY			
PRIORITY NUMBER	DATE	COUNTRY	
2012-026396	30/10/2012	JAPAN	
DESIGN NUMBER	253599		
CLASS	08-07		
1)PNL METALWARE PVT. LTD., PLOT NO.: G-1843, KISHAN GATE ROAD, G.I.D.C. METODA (LODHKA), TALUKA: LODHIKA, DIST.: RAJKOT-360021. GUJARAT, INDIA, INDIAN COMPANY			
DATE OF REGISTRATION	01/05/2013		
TITLE	DOOR BOLT		
PRIORITY NA			

DESIGN NUMBER	252749	
CLASS	08-06	
1)PADMA TRADERS., (AN INDIAN SOLE PROPRIETORSHIP CONCERN), HAVING OFFICE AT ROOM NO. 4, SURESH TIWARI CHAWL, B/H WELCOME PLYWOOD, 3RD CARTER ROAD, BORIVALI (EAST), MUMBAI-400066, MAHARASHTRA, INDIA. WHOSE PROPRIETOR IS VIKAS JAIN. (INDIAN NATIONAL) OF ABOVE ADDRESS		
DATE OF REGISTRATION	02/04/2013	
TITLE	HANDLE	
PRIORITY NA		
DESIGN NUMBER	250548	
CLASS	23-03	
1)M/S V-GUARD INDUSTRIES LTD., AN INDIAN COMPANY INCORPORATED UNDER THE COMPANIES ACT OF 1956 WHOSE ADDRESS IS 33/2905 F, VENNALA HIGH SCHOOL ROAD, VENNALA, KOCHI-682028, KERALA STATE, INDIA		
DATE OF REGISTRATION	31/12/2012	
TITLE	WATER HEATERS	
PRIORITY NA		
DESIGN NUMBER	252220	
CLASS	08-06	
1)(1) GOPALBHAI MAVJIBHAI SAAVARIYA (2) KALPESHBHAI KANTIBHAI KANANI (3) HASMUKHBHAI CHHAGANBHAI BEDIYA (ALL THE PARTNERS ARE ADULT AND INDIAN NATIONAL) PARTNERS OF TARSHI MANUFACTURES (INDIAN PARTNERSHIP FIRM) HAVING PLACE OF BUSINESS AT: 50, FEET MAIN ROAD, PATEL NAGAR-2, SADBHAVNA SOCIETY, BHOJA BHAGAT CHOWK, RAJKOT-360002- GUJARAT (INDIA)		
DATE OF REGISTRATION	08/03/2013	
TITLE	HANDLE	
PRIORITY NA		

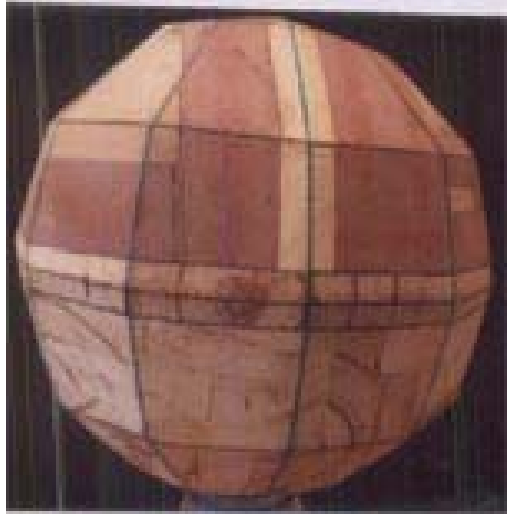
DESIGN NUMBER	251258	
CLASS	19-07	
1)GHULAM HASSAN SHAH, R/O MAKAND PORA, P/O DANOW BOGUND (192231) TEH./DISTT. KULGAM JAMMU & KASHMIR, INDIAN		
DATE OF REGISTRATION	29/01/2013	
TITLE	MODEL OF GLOBE	
PRIORITY NA		

DESIGN NUMBER	253966	
CLASS	09-07	
1)SULZER MIXPAC AG, RÜTISTRASSE 7, 9469 HAAG, SWITZERLAND		
DATE OF REGISTRATION	20/05/2013	
TITLE	CAP	
PRIORITY		
PRIORITY NUMBER	DATE	COUNTRY
139 632	13/02/2013	SWITZERLAND

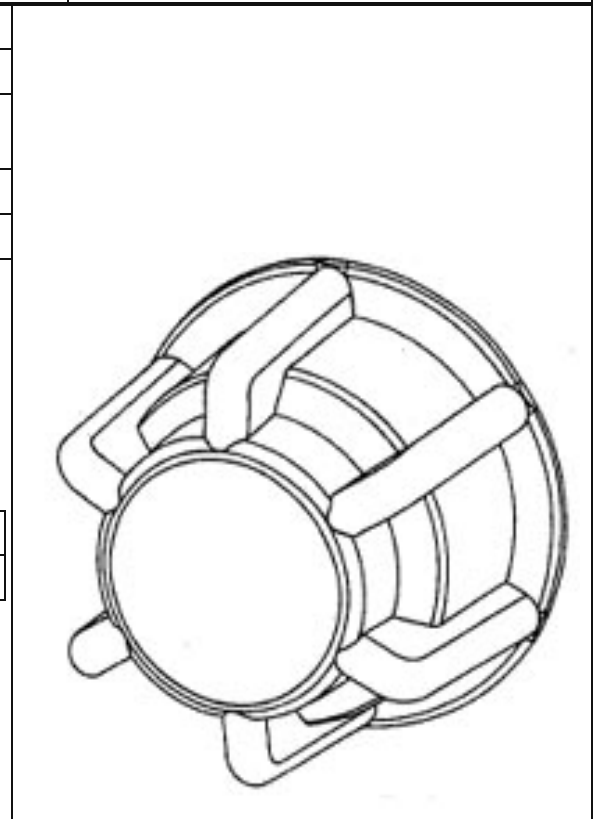

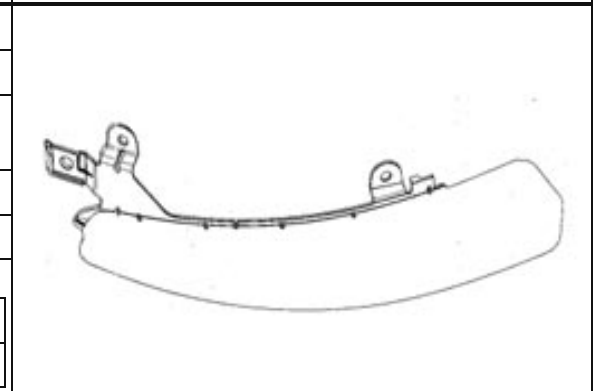

DESIGN NUMBER	252911	
CLASS	12-16	
1)SCANIA CV AB, SE-151 87, SÖDERTÄLJE, SWEDEN		
DATE OF REGISTRATION	05/04/2013	
TITLE	CAB CORNER PANEL FOR VEHICLE	
PRIORITY		
PRIORITY NUMBER	DATE	COUNTRY
2012/0447	10/10/2012	SWEDEN





DESIGN NUMBER	254189	
----------------------	--------	--

CLASS	08-06		
1)AMTUL HASEEN W/O LATE NISAR AHMED AGED ABOUT 58 YEARS R/O 91/73, IFTIKHARABAD KANPUR (U.P.) INDIA, OF ABOVE ADDRESS			
DATE OF REGISTRATION	30/05/2013		
TITLE	HANDLE		
PRIORITY NA			
DESIGN NUMBER	250290		
CLASS	12-16		
1)TREND EAST YUGEN KAISHA, OF FAMILE NARIMASU GRANDAGE NO. 104, 32-22, ASAHICYO 3-CHOME, NERIMA-KU, TOKYO, JAPAN, A JAPANESE COMPANY			
DATE OF REGISTRATION	18/12/2012		
TITLE	WIPER FOR AUTOMOBILE		
PRIORITY			
PRIORITY NUMBER	DATE	COUNTRY	
15957/2012	05/07/2012	JAPAN	
DESIGN NUMBER	252494		
CLASS	13-03		
1)CROMPTON GREAVES LIMITED, (AN INDIAN COMPANY), AVANTHA HOUSE, 6TH FLOOR, DR. ANNIE BESANT ROAD, WORLI, MUMBAI-400030, MAHARASHTRA, INDIA			
DATE OF REGISTRATION	20/03/2013		
TITLE	SELF POWERED PROTECTIVE RELAY		
PRIORITY NA			

DESIGN NUMBER	253783	
CLASS	09-05	
1)G. M. INTERNATIONAL, AN INDIAN PROPRIETORSHIP CONCERN OF 15, BRABOURNE ROAD, 2ND FLOOR, BANERJEE BHAWAN, KOLKATA-700001, WEST BENGAL, INDIA, WHOSE PROPRIETOR IS BHARAT KUMAR JAIN OF THE SAME ADDRESS, AN INDIAN NATIONAL		
DATE OF REGISTRATION	13/05/2013	
TITLE	PACKAGING FOR TONGUE CLEANER	
PRIORITY NA		

DESIGN NUMBER	254740	
CLASS	07-06	
1)MA DESIGN INDIA PRIVATE LIMITED, A COMPANY INCORPORATED IN INDIA HAVING ITS PRINCIPAL PLACE OF BUSINESS AT A-41, SECTOR-80, PHASE-II, NOIDA-201305, U.P. INDIA		
DATE OF REGISTRATION	25/06/2013	
TITLE	HOLDER (FOR TOOTHPICKS)	
PRIORITY NA		

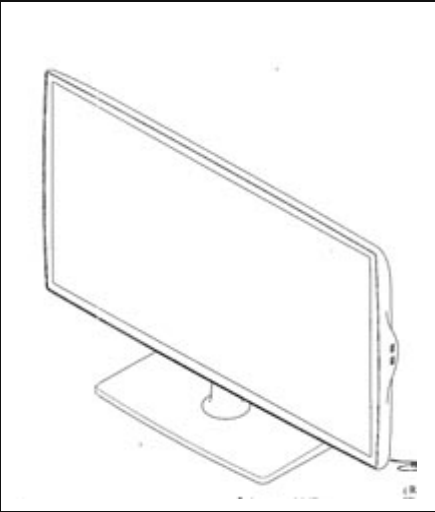
DESIGN NUMBER	254775	
CLASS	15-03	
1)M/S. F. C. INDUSTRIES, BATHINDA ROAD, NEAR D. A. V SCHOOL, JAITU-151202, DISTT. FARIDKOT (PUNJAB) INDIA AN INDIAN PROPRIETORSHIP FIRM WHOSE PROPRIETOR IS:- VISHAL KUMAR BEING INDIAN NATIONALS OF THE ABOVE ADDRESS		
DATE OF REGISTRATION	25/06/2013	
TITLE	CHUFF CUTTING MACHINE	
PRIORITY NA		

DESIGN NUMBER	252156		
CLASS	14-03		
1)SAMSUNG ELECTRONICS CO., LTD. 129, SAMSUNG-RO, YEONGTONG-GU, SUWON-SI, GYEONGGI-DO, 443-742, REPUBLIC OF KOREA, A COMPANY OF REPUBLIC OF KOREA			
DATE OF REGISTRATION	06/03/2013		
TITLE	TELEVISION RECEIVER		
PRIORITY			
PRIORITY NUMBER	DATE	COUNTRY	
30-2012-0050290	23/10/2012	REPUBLIC OF KOREA	
DESIGN NUMBER	253443		
CLASS	14-03		
1)VIDEOCON INDUSTRIES LIMITED. A COMPANY INCORPORATED UNDER THE INDIAN COMPANIES ACT, AT 14 KMS. STONE, AURANGABAD-PAITHAN ROAD, CHITEGAON, TQ.PAITHAN, DIST. AURANGABAD-431105, MAHARASHTRA, INDIA			
DATE OF REGISTRATION	26/04/2013		
TITLE	TELEVISION		
PRIORITY NA			
DESIGN NUMBER	253593		
CLASS	26-06		
1)RCJ AUTO FORGE PVT LTD., E-756-757, PHASE-VII, FOCAL POINT, LUDHIANA-141010 (PUNJAB) INDIA (AN INDIAN COMPANY DULY REGISTERED UNDER THE COMPANIES ACT, 1956) OF THE ABOVE ADDRESS			
DATE OF REGISTRATION	01/05/2013		
TITLE	FRONT LIGHT FOR AUTO RICKSHAW		
PRIORITY NA			

DESIGN NUMBER	254892	
CLASS	12-16	
1)TATA MOTORS LIMITED, AN INDIAN COMPANY OF BOMBAY HOUSE, 24 HOMI MODY STREET, HUTATMA CHOWK, MUMBAI 400001, INDIA		
DATE OF REGISTRATION	01/07/2013	
TITLE	FRONT GRILL WITH LAMP OF A CAR	
PRIORITY NA		

DESIGN NUMBER	240117	
CLASS	15-03	
1)INDIAN COUNCIL OF AGRICULTURAL RESEARCH, KRISHI BHAWAN, DR. RAJENDRA PRASAD ROAD, NEW DELHI-110001.		
DATE OF REGISTRATION	12/10/2011	
TITLE	GRASS CUTTER	
PRIORITY NA		

DESIGN NUMBER	250433	
CLASS	01-01	
1)MR. ADITYA SINGHAL (AN INDIAN NATIONAL), TRADING AS M/S. UDITI INTERNATIONAL, 3528, 1ST FLOOR (MEZANNINE), SADAR BAZAR, DELHI-110006		
DATE OF REGISTRATION	24/12/2012	
TITLE	CHOCOLATE	
PRIORITY NA		

DESIGN NUMBER	250547	
CLASS	23-03	
1)M/S V-GUARD INDUSTRIES LTD., AN INDIAN COMPANY INCORPORATED UNDER THE COMPANIES ACT OF 1956 WHOSE ADDRESS IS 33/2905 F, VENNALA HIGH SCHOOL ROAD, VENNALA, KOCHI-682028, KERALA STATE, INDIA		
DATE OF REGISTRATION	31/12/2012	
TITLE	WATER HEATERS	
PRIORITY NA		

DESIGN NUMBER	252316	
CLASS	24-01	
1)SIEMENS AKTIENGESELLSCHAFT, OF WITTELSBACHERPLATZ 2, 80333 MUNCHEN, GERMANY, A GERMAN COMPANY		
DATE OF REGISTRATION	14/03/2013	
TITLE	MOBILE X-RAY APPARATUS (C ARC)	
PRIORITY		
PRIORITY NUMBER	DATE	COUNTRY
EU 001347215	04/10/2012	OHIM

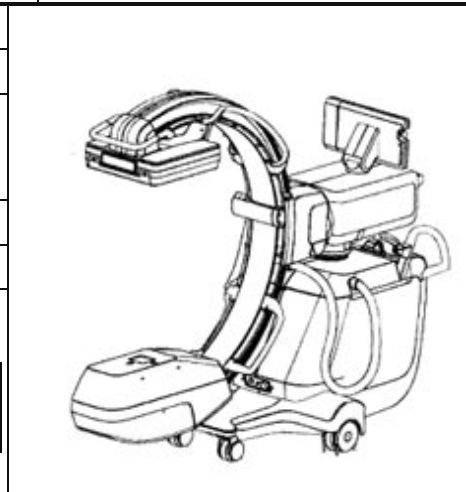

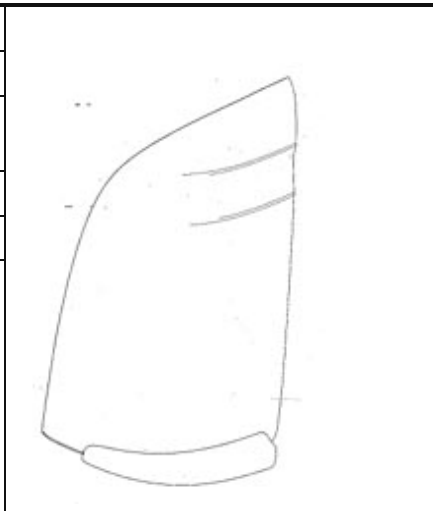

DESIGN NUMBER	252910	
CLASS	12-16	
1)SCANIA CV AB, SE-151 87, SÖDERTÄLJE, SWEDEN		
DATE OF REGISTRATION	05/04/2013	
TITLE	CAB CORNER PANEL FOR VEHICLE	
PRIORITY		
PRIORITY NUMBER	DATE	COUNTRY
2012/0447	10/10/2012	SWEDEN





DESIGN NUMBER	254097	
CLASS	23-04	
1)DAIKIN INDUSTRIES LTD. A JAPANESE COMPANY OF THE ADDRESS: UMEDA CENTER BUILDING, 4-12 NAKAZAKI-NISHI 2-CHOME, KITA-KU, OSAKA-SHI, OSAKA-FU, JAPAN		
DATE OF REGISTRATION	27/05/2013	
TITLE	AIR CONDITIONER	
PRIORITY NA		
DESIGN NUMBER	254188	
CLASS	23-01	
1)M/S. AQUIONICS DEVELOPMENTS INDIA (P) LTD., WHOSE ADDRESS UG-5, WEST END MALL, JANAK PLACE, JANAKPURI, NEW DELHI-110058, INDIAN		
DATE OF REGISTRATION	30/05/2013	
TITLE	WATER PURIFIER	
PRIORITY NA		
DESIGN NUMBER	254287	
CLASS	12-16	
1)RENAULT TRUCKS, A COMPANY ORGANIZED UNDER THE LAWS OF FRANCE, OF 99 ROUTE DE LYON, 69800 SAINT PRIEST, FRANCE		
DATE OF REGISTRATION	06/06/2013	
TITLE	MUDGUARD FOR VEHICLE	
PRIORITY NA		

DESIGN NUMBER	252491	
CLASS	13-03	
1)CROMPTON GREAVES LIMITED, (AN INDIAN COMPANY), AVANTHA HOUSE, 6TH FLOOR, DR. ANNIE BESANT ROAD, WORLI, MUMBAI-400030, MAHARASHTRA, INDIA		
DATE OF REGISTRATION	20/03/2013	
TITLE	SELF POWERED PROTECTIVE RELAY	
PRIORITY NA		
DESIGN NUMBER	253782	
CLASS	28-99	
1)G. M. INTERNATIONAL, AN INDIAN PROPRIETORSHIP CONCERN OF 15, BRABOURNE ROAD, 2ND FLOOR, BANERJEE BHAWAN, KOLKATA-700001, WEST BENGAL, INDIA, WHOSE PROPRIETOR IS BHARAT KUMAR JAIN OF THE SAME ADDRESS, AN INDIAN NATIONAL		
DATE OF REGISTRATION	13/05/2013	
TITLE	TONGUE CLEANER	
PRIORITY NA		
DESIGN NUMBER	254663	
CLASS	10-99	
1)A-GRAIN (INDIA), PLOT NO 27, SHIVAJI PARK, OPP. SECTOR-9, AMBALA CITY, HARYANA, INDIA		
DATE OF REGISTRATION	21/06/2013	
TITLE	MOISTURE TESTER	
PRIORITY NA		

DESIGN NUMBER	254774	
CLASS	13-01	
1)M/S. F. C. INDUSTRIES, BATHINDA ROAD, NEAR D. A. V SCHOOL, JAITU-151202, DISTT. FARIDKOT (PUNJAB) INDIA AN INDIAN PROPRIETORSHIP FIRM WHOSE PROPRIETOR IS:- VISHAL KUMAR BEING INDIAN NATIONALS OF THE ABOVE ADDRESS		
DATE OF REGISTRATION	25/06/2013	
TITLE	GENERATOR SET	
PRIORITY NA		

DESIGN NUMBER	254790	
CLASS	08-06	
1)ITALIK METALWARE PVT. LTD., G: 212-215, LODHIKA, G.I.D.C., KALAWAD ROAD, METODA, RAJKOT-360003, STATE OF GUJARAT INDIA, / A PRIVATE LIMITED COMPANY INCORPORATED UNDER INDIAN COMPANIES ACT., ABOVE ADDRESS		
DATE OF REGISTRATION	25/06/2013	
TITLE	HANDLE	
PRIORITY NA		

DESIGN NUMBER	253442	
CLASS	13-02	
1)MANIKA MOULDS PVT. LTD., A COMPANY INCORPORATED UNDER THE INDIAN COMPANIES ACT, AAR-PEE CENTRE, 601-605, 6TH FLOOR GUFFIC COMPOUND, MIDC, ANDHERI (E), MUMBAI-400093, MAHARASHTRA, INDIA		
DATE OF REGISTRATION	26/04/2013	
TITLE	BATTERY LID	
PRIORITY NA		

DESIGN NUMBER	253582		
CLASS	24-02		
1)SANTEN PHARMACEUTICAL CO., LTD., OF 9-19, SHIMOSHINJO 3-CHOME, HIGASHIYODOGAWA-KU, OSAKA-SHI, OSAKA 5338651, JAPAN			
DATE OF REGISTRATION	30/04/2013		
TITLE	INTRAOCULAR LENS IMPLANTATION DEVICE		
PRIORITY			
PRIORITY NUMBER	DATE	COUNTRY	
2012-026401	30/10/2012	JAPAN	
DESIGN NUMBER	254837		
CLASS	12-11		
1)BAJAJ AUTO LIMITED, AN INDIAN COMPANY, INCORPORATED UNDER THE COMPANIES ACT OF 1956, HAVING ITS PRINCIPAL PLACE OF BUSINESS AT NEW 2ND & 3RD FLOOR, KHIVRAJ BUILDING, NO. 616, ANNASALAI, CHENNAI - 600006, STATE OF TAMIL NADU, INDIA, AND REGISTERED OFFICE AT AKURDI, PUNE-411035, STATE OF MAHARASHTRA, INDIA			
DATE OF REGISTRATION	27/06/2013		
TITLE	FAIRING FOR MOTORCYCLE		
PRIORITY NA			