

INTRODUCTION

In view of the recent amendment made in the Designs (Amendment) Rules, 2008 with effect from 17/06/2008, Publication of the matter relating to Designs is being published in the Official Journal of The Patent Office. This Journal is being published on weekly basis on every Friday covering the various proceedings on Designs as required according to the provisions of under Rule 22, 25, 27 and 39 of the Design (Amendment) Rules, 2008. All the enquiries on this Official Journal and other information as required by the public should be addressed to the Controller General of Patents, Designs & Trade Marks. Suggestions and comments are requested from all quarters so that the content can be enriched.

DESIGN ACT 2000
(Under Section 31)
RECTIFICATION OF REGISTER

Eastman Industries Limited, Ludhiana, filed a request on Form-17 on 19/11/2013 through their agent S. S. Mahtta of M/s Mahtta & Co., Ludhiana, for the Rectification of name of the article under sec.31 of the Designs Act, 2000 in the Register of Designs is as follows:-

Design No.	Entered name of the Article	Changed to
247412	CLAMP FOR SIDE- STAND OF BICYCLE	CLAMP FOR SIDE SUPPORT OF BICYCLE
247411	CLAMP FOR SIDE-STAND OF BICYCLE	CLAMP FOR SIDE SUPPORT OF BICYCLE
247410	CLAMP FOR SIDE STAND OF BICYCLE	CLAMP FOR SIDE SUPPORT OF BICYLCE

Notice of opposition to the Rectification of Register of Designs may be given as per rule 40 of the Design Rules, 2001 as amended Design (Amendment) Rules, 2008.

COPYRIGHT PUBLICATION

SL NO	CASE NUMBERS	RENEWED ON
1.	192299	20.11.2013
2.	193095	20.11.2013
3.	193100	19.11.2013
4.	193951	20.11.2013
5.	194045	19.11.2013
6.	194055	19.11.2013
7.	194594	19.11.2013
8.	194658	19.11.2013
9.	195093	19.11.2013
10.	195094	19.11.2013
11.	195994	19.11.2013
12.	213440	18.11.2013
13.	235269	14.11.2013
14.	240558	20.11.2013
15.	246712	20.12.2013
16.	249794	29.11.2013
17.	250207	20.12.2013

CANCELLATION PROCEEDINGS
under Section 19 of the Designs Act, 2000

“The Asstt. Controller of Patents & Designs passed an order on 27/12/2013 to dismiss the petition filed by Pradeep Mathur, S/o. Shri B.P. Mathur, A-89, Nehru Vihar, Timarpur, Delhi - 110054 on 12/3/2010 for cancellation of the registration of registered Design No.178564 dated 27/1/1999 under Class 10 titled as ‘Footwear’ in the name of Noor Pratap Rana and Ashok Kumar Vohti, trading as KIRAN SHOES MANUFACTURERS, a partnership firm whose partners are Nepalis by nationality of Post Box No.497, Maharajganj, Ring Road, Kathmandu, Nepal.”

REGISTRATION OF DESIGNS

The following designs have been registered. They are now open for public inspection. In the following each entry the Date of Registration is shown. The Priority Number, Priority Date and Priority Country are also shown

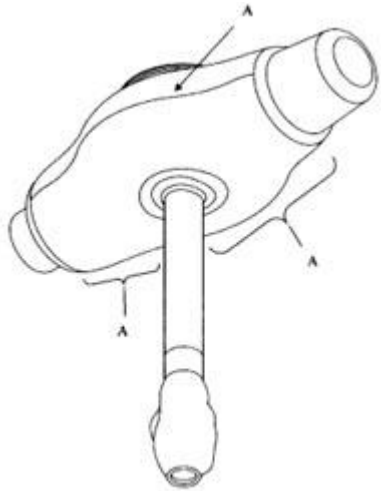
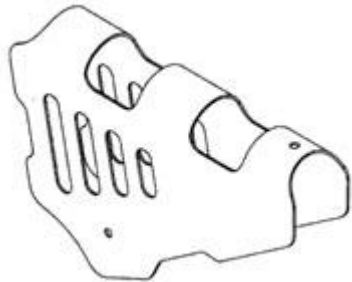
DESIGN NUMBER	246056		
CLASS	24-04		
1) KIMBERLY-CLARK WORLDWIDE INC, 2300 WINCHESTER ROAD, NEENAH, WISCONSIN 54956, USA			
DATE OF REGISTRATION	20/06/2012		
TITLE	ENTERAL FEEDING TUBE BASE		
PRIORITY			
PRIORITY NUMBER	DATE	COUNTRY	
29/409358	22/12/2011	U.S.A.	
DESIGN NUMBER			
CLASS	12-11		
1) LA BICYCLE (THAILAND) CO. LTD., A COMPANY INCORPORATED UNDER THE LAWS OF THAILAND, 58 MOO 2, TAMBOL OAM-YAI, AMPHUR SAMPRAN, NAKORNPATHEM PROVINCE 73160, THAILAND			
DATE OF REGISTRATION	31/12/2012		
TITLE	BOTTOM GUSSET OF BICYCLE		
PRIORITY NA			
DESIGN NUMBER			
CLASS	21-01		
1) DR. ING. H.C.F. PORSCHE AKTIENGESELLSCHAFT, A GERMAN COMPANY OF PORSCHEPLATZ 1, 70435 STUTTGART, GERMANY			
DATE OF REGISTRATION	07/03/2013		
TITLE	TOY CAR		
PRIORITY NA			

DESIGN NUMBER	253947	
CLASS	23-01	
1)RAJHANS CHEMICALS & PLASTIC INDUSTRIES, B-70/76, DSIDC INDUSTRIAL AREA, LAWRENCE ROAD, DELHI-110035, INDIA. (AN INDIAN PARTNERSHIP FIRM WHOSE PARTNERS ARE :- SH. SANJEEV JAIN AND SMT. SHAKUNTLA DEVI JAIN AN INDIAN NATIONAL OF THE ABOVE ADDRESS		
DATE OF REGISTRATION	17/05/2013	
TITLE	WATER TAP	
PRIORITY NA		

DESIGN NUMBER	252742	
CLASS	08-06	
1)LALJIBHAI PANCHABHAI ROKAD (INDIAN NATIONAL) AND SOLE PROPRIETOR OF SITARAM METAL HAVING PLACE OF BUSINESS AT-3, PATEL NAGAR, 80 FEET ROAD, OPP: PATEL TOOLS, RAJKOT-360002 - GUJARAT (INDIA)		
DATE OF REGISTRATION	02/04/2013	
TITLE	HANDLE	
PRIORITY NA		

DESIGN NUMBER	252773	
CLASS	23-99	
1)MINDA INDUSTRIES LTD. (AUTOGAS DIVISION) AN INDIAN COMPANY OF VILLAGE NAHARPUR KASAN, P.O. NAKHROLA, IMT MANESAR, DISTT. GURGAON, HARYANA-122050		
DATE OF REGISTRATION	02/04/2013	
TITLE	OUTLET VALVE FOR HIGH PRESSURE GAS REGULATOR	
PRIORITY NA		

DESIGN NUMBER	252853	
CLASS	10-01	
1)AJANTA LIMITED, AN INDIAN COMPANY OF ORPAT INDUSTRIAL ESTATE, RAJKOT-MORBI HIGHWAY, MORBI 363641, STATE OF GUJARAT, INDIA		
DATE OF REGISTRATION	03/04/2013	
TITLE	CLOCK	
PRIORITY NA		
		
DESIGN NUMBER	252865	
CLASS	10-01	
1)AJANTA LIMITED, AN INDIAN COMPANY OF ORPAT INDUSTRIAL ESTATE, RAJKOT-MORBI HIGHWAY, MORBI 363641, STATE OF GUJARAT, INDIA		
DATE OF REGISTRATION	03/04/2013	
TITLE	CLOCK	
PRIORITY NA		
		
DESIGN NUMBER	249776	
CLASS	10-05	
1)OMRON CORPORATION, A CORPORATION ORGANIZED AND EXISTING UNDER THE LAWS OF JAPAN, OF 801, MINAMIFUDODO-CHO, HORIKAWAHIGASHIIRU, SHIOKOJI-DORI, SHIMOGYO-KU, KYOTO-SHI, KYOTO 600-8530, JAPAN		
DATE OF REGISTRATION	29/11/2012	
TITLE	HEAD FOR PHOTOELECTRIC SENSOR	
PRIORITY		
PRIORITY NUMBER	DATE	COUNTRY
2012-13561	07/06/2012	JAPAN
		

DESIGN NUMBER	252924	
CLASS	09-03	
1)J. G. HOSIERY PRIVATE LIMITED, COMPANY INCORPORATED UNDER THE COMPANIES ACT, 1956, HAVING ITS REGISTERED OFFICE AT SF-58/1, SOLIPALAYAM ROAD, 15, VELAMPALAYAM, TIRUPUR, TAMIL NADU-641652, INDIA		
DATE OF REGISTRATION	05/04/2013	
TITLE	PACKAGE BOX	
PRIORITY NA		
DESIGN NUMBER	254475	
CLASS	12-16	
1)AUDI AG, A JOINT STOCK COMPANY ESTABLISHED UNDER GERMAN LAW, OF 85045 INGOLSTADT, GERMANY		
DATE OF REGISTRATION	13/06/2013	
TITLE	WHEEL RIM	
PRIORITY		
PRIORITY NUMBER	DATE	COUNTRY
002153528-0003	14/12/2012	OHIM
DESIGN NUMBER	251864	
CLASS	24-01	
1)(1) ABHISHEK SEN, AN INDIAN NATIONAL WHOSE ADDRESS IS “ARPAN , PLOT NO. 12, TRIMBAK NAGAR, OFF JAI BHAVANI ROAD, NASHIK ROAD, NASHIK-422101, MAHARASHTRA, INDIA (2) AMAN MIDHA, AN INDIAN NATIONAL WHOSE ADDRESS IS 30 GROUND FLOOR, SANT ISHAR SINGH NAGAR, PAKHOWAL ROAD, LUDHIANA-141002, PUNJAB AND (3) SHAAKIR. M AN INDIAN NATIONAL WHOSE ADDRESS IS QUARTER NO: 102, FACT CD TOWNSHIP, AMBALAMEDU P.O, COCHIN 682303, KERALA, INDIA ALL BEING JOINT APPLICANTS		
DATE OF REGISTRATION	25/02/2013	
TITLE	RECEPTICLE FOR BODY FLUID ANALYSIS	
PRIORITY NA		

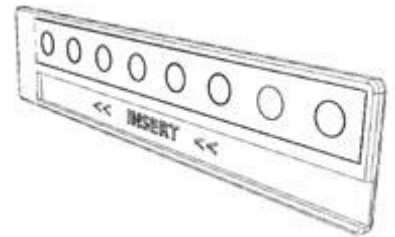

DESIGN NUMBER	251950	
CLASS	12-06	
1)ULSTEIN POWER & CONTROL AS, POSTBOKS 278, 6067 ULSTEINVIK, NORWAY, NATIONALITY: NORWAY		
DATE OF REGISTRATION	28/02/2013	
TITLE	SHIP BRIDGE	
PRIORITY		
PRIORITY NUMBER	DATE	COUNTRY
20120723	28/08/2012	NORWAY

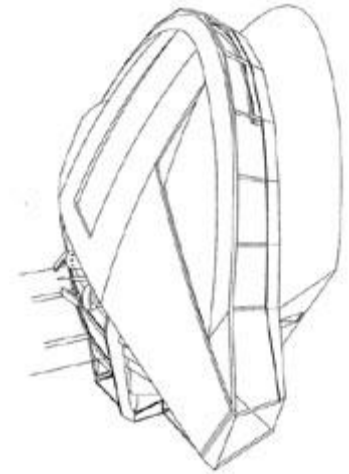

DESIGN NUMBER	252602	
CLASS	09-03	
1)FREEMANS MEASURES PVT. LTD, AN INDIAN COMPANY, G. T. ROAD, JUGIANA, LUDHIANA - 141117, PUNJAB, INDIA, AN INDIAN COMPANY		
DATE OF REGISTRATION	22/03/2013	
TITLE	PACKAGING BOX	
PRIORITY NA		



DESIGN NUMBER	249404	
CLASS	19-06	
1)EUROPE BRANDS S.A.R.L., 412F, ROUTE D' ESCH, L-2086, LUXEMBOURG.		
DATE OF REGISTRATION	09/11/2012	
TITLE	REFILL FOR A WRITING INSTRUMENT	
PRIORITY		
PRIORITY NUMBER	DATE	COUNTRY
001325898	11/05/2012	OHIM



DESIGN NUMBER	252375	
CLASS	14-03	
1)VERTU CORPORATION LIMITED, A COMPANY ORGANIZED AND EXISTING UNDER THE LAWS OF UNITED KINGDOM, OF THE ADDRESS BEACON HILL ROAD, CHURCH CROOKHAM, HAMPSHIRE GU52 8DY, UNITED KINGDOM		
DATE OF REGISTRATION	18/03/2013	
TITLE	MOBILE PHONE	
PRIORITY		
PRIORITY NUMBER	DATE	COUNTRY
29/433729	04/10/2012	U.S.A.



DESIGN NUMBER	250506	
CLASS	13-03	
1)ARUN ENTERPRISES, B-48, SITE-4, SAHIBABAD-201010, GHAZIABAD, U.P., INDIA. (AN INDIAN PARTNERSHIP FIRM WHOSE PARTNERS ARE:- SH. CHARANJIT LAL DHIR, SH. ARUN DHIR, SH. TARUN DHIR. AN INDIAN NATIONAL OF THE ABOVE ADDRESS		
DATE OF REGISTRATION	28/12/2012	
TITLE	CONNECTOR USED IN ELECTRIC METER	
PRIORITY NA		

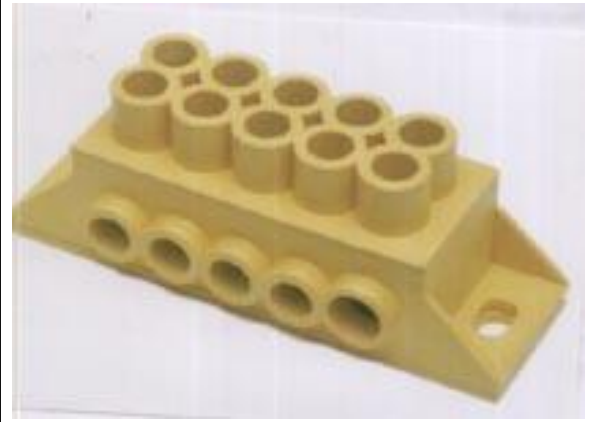

DESIGN NUMBER	247288	
CLASS	12-11	
1)TVS MOTOR COMPANY LIMITED, AN INDIAN COMPANY INCORPORATED UNDER THE COMPANIES ACT, 1956, HAVING ITS REGISTERED OFFICE AT "JAYALAKSHMI ESTATE", 29 (OLD NO. 8) HADDOWS ROAD, CHENNAI - 600006, TAMIL NADU, INDIA		
DATE OF REGISTRATION	22/08/2012	
TITLE	MOTORCYCLE	
PRIORITY NA		

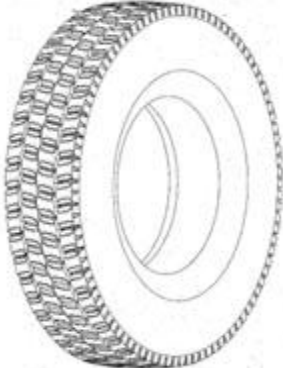
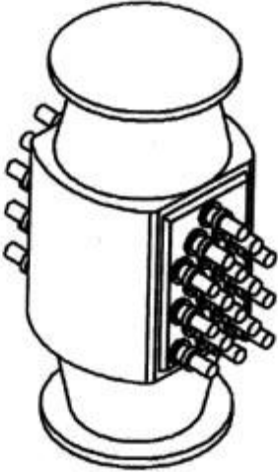

DESIGN NUMBER	252737		
CLASS	24-02		
1)KONINKLIJKE PHILIPS ELECTRONICS N.V., A COMPANY ORGANIZED AND EXISTING UNDER THE LAWS OF THE KINGDOM OF THE NETHERLANDS, RESIDING AT EINDHOVEN, WHOSE POST-OFFICE ADDRESS IS HIGH TECH CAMPUS 5, 5656 AE EINDHOVEN, THE NETHERLANDS			
DATE OF REGISTRATION	01/04/2013		
TITLE	FRAME FOR A PATIENT INTERFACE ASSEMBLY		
PRIORITY			
PRIORITY NUMBER	DATE	COUNTRY	
002112755-0003	03/10/2012	OHIM	
DESIGN NUMBER	252850		
CLASS	10-01		
1)AJANTA LIMITED, AN INDIAN COMPANY OF ORPAT INDUSTRIAL ESTATE, RAJKOT-MORBI HIGHWAY, MORBI 363641, STATE OF GUJARAT, INDIA			
DATE OF REGISTRATION	03/04/2013		
TITLE	CLOCK		
PRIORITY NA			
DESIGN NUMBER	252863		
CLASS	10-01		
1)AJANTA LIMITED, AN INDIAN COMPANY OF ORPAT INDUSTRIAL ESTATE, RAJKOT-MORBI HIGHWAY, MORBI 363641, STATE OF GUJARAT, INDIA			
DATE OF REGISTRATION	03/04/2013		
TITLE	CLOCK		
PRIORITY NA			

DESIGN NUMBER	252895		
CLASS	24-02		
1)POLY MEDICURE LIMITED, AN INDIAN COMPANY, OF PLOT NO. 105, SECTOR 59, HSIIDC INDUSTRIAL AREA, FARIDABAD, HARYANA-121004, INDIA			
DATE OF REGISTRATION	04/04/2013		
TITLE	SAFETY COVER OF FISTULA NEEDLE SET		
PRIORITY NA			
DESIGN NUMBER	254787		
CLASS	12-15		
1)COMPAGNIE GENERALE DES ETABLISSEMENTS MICHELIN, A FRENCH COMPANY OF 12 COURS SABLON, FR-63000, CLERMONT-FERRAND, FRANCE, AND MICHELIN RECHERCHE ET TECHNIQUE S.A., A SWISS COMPANY OF ROUTE LOUIS BRAILLE 10 - CH-1763 GRANGES-PACCOT, SWITZERLAND			
DATE OF REGISTRATION	25/06/2013		
TITLE	TYRE		
PRIORITY			
PRIORITY NUMBER	DATE	COUNTRY	
12/5756	26/12/2012	FRANCE	
DESIGN NUMBER	252932		
CLASS	23-02		
1)ALFAWALL AB, OF HANS STAHLER VÄG 7, SE-147 41 TUMBA, SWEDEN, A SWEDISH COMPANY			
DATE OF REGISTRATION	05/04/2013		
TITLE	WATER TREATMENT REACTOR		
PRIORITY			
PRIORITY NUMBER	DATE	COUNTRY	
002133736-0002	09/11/2012	OHIM	

DESIGN NUMBER	254460	
CLASS	07-01	
1)EXPORTS INTERNATIONAL CORPORATION, 124 E, SAINIK FARMS, CENTRAL AVENUE, LANE C-8/2, NEW DELHI-110062, INDIA, AN INDIAN COMPANY		
DATE OF REGISTRATION	12/06/2013	
TITLE	PITCHER	
PRIORITY NA		
DESIGN NUMBER	250150	
CLASS	21-01	
1)SANDEEP SINGH RESIDING AT: 184 GIRISH GHOSH ROAD, BELUR, HOWRAH 711202		
DATE OF REGISTRATION	13/12/2012	
TITLE	GAME BOARD	
PRIORITY NA		
DESIGN NUMBER	250237	
CLASS	15-04	
1)M/S. CATERPILLAR INC.; AN AMERICAN CORPORATION, OF THE ADDRESS 100 NE ADAMS STREET, PEORIA, IL 61269, UNITED STATES OF AMERICA		
DATE OF REGISTRATION	17/12/2012	
TITLE	UNDERCARRIAGE TRACK IDLER FOR MOBILE EARTHMOVING MACHINE	
PRIORITY		
PRIORITY NUMBER	DATE	COUNTRY
29/426,074	29/06/2012	U.S.A.



DESIGN NUMBER	251739	
CLASS	13-03	
1)SIEMENS AKTIENGESELLSCHAFT, OF WITTELSBACHERPLATZ 2, 80333 MUNCHEN, GERMANY, A GERMAN COMPANY		
DATE OF REGISTRATION	18/02/2013	
TITLE	SAFETY RELAY	
PRIORITY		
PRIORITY NUMBER	DATE	COUNTRY
001340897	24/08/2012	OHIM

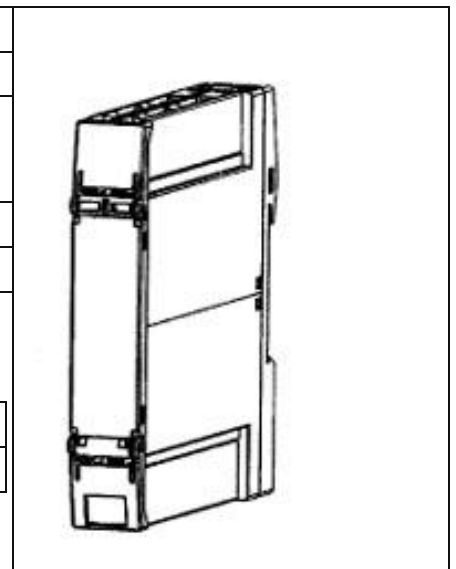

DESIGN NUMBER	250066	
CLASS	08-09	
1)RAUMPLUS BESITZ-UND ENTWICKLUNGS-GMBH & CO. KG, DORTMUNDER STRASSE 35, 28199 BREMEN, GERMANY		
DATE OF REGISTRATION	11/12/2012	
TITLE	FITTINGS FOR DOORS, WINDOWS AND/OR FURNITURE	
PRIORITY NA		

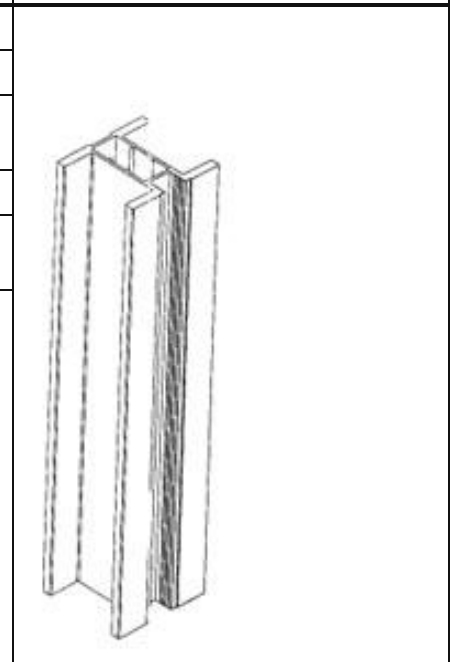

DESIGN NUMBER	252599	
CLASS	02-05	
1)RUBY MOHAMMED, AN INDIAN NATIONAL, GENESIS TRENDSETTERS, 12/771, SARAYU NAGAR, CHANDRA NAGAR, PALAKKAD, KERALA-678007		
DATE OF REGISTRATION	22/03/2013	
TITLE	SCARF	
PRIORITY NA		





DESIGN NUMBER	251409	
CLASS	09-01	
1)EURO INDIA FRESH FOODS PRIVATE LIMITED (A COMPANY INCORPORATED UNDER THE COMPANIES ACT, 1956) HAVING HIS PLACE OF BUSINESS AT 609, PRINCESS PLAZA, SARDAR CHOWK, VARACHHA ROAD, SURAT-395006 GUJARAT (INDIA)		
DATE OF REGISTRATION	05/02/2013	
TITLE	BOTTLE	
PRIORITY NA		
DESIGN NUMBER	249438	
CLASS	12-16	
1)CONCENTRIC PUMPS PUNE PVT. LTD. A COMPANY REGISTERED UNDER COMPANY ACT 1956 OF GAT NO. 26/1, 27 & 28 (PART), OFF PUNE-NAGAR ROAD, VILLAGE LONIKAND, P.O. LONIKAND, TALUKA HAVELI, PUNE-412216, MAHARASHTRA, INDIA		
DATE OF REGISTRATION	12/11/2012	
TITLE	ENGINE COOLING WATER PUMP USED IN AUTOMOBILE	
PRIORITY NA		
DESIGN NUMBER	254107	
CLASS	13-03	
1)SHREE INDUSTRIES, AN INDIAN PROPRIETORSHIP CONCERN OF 30, SAMRAT IND. AREA, B/H. S.T. WORKSHOP, GONDAL ROAD, RAJKOT, GUJARAT, INDIA, WHOSE PROPRIETOR IS NILESHBHAI BHIKHABHAI KAPURIYA OF THE SAME ADDRESS, AN INDIAN NATIONAL		
DATE OF REGISTRATION	28/05/2013	
TITLE	LIMIT CONTROL SWITCH	
PRIORITY NA		

DESIGN NUMBER	252125		
CLASS	21-01		
1)INNOVATION FIRST, INC. ADDRESS AT 1519 INTERSTATE 30 WEST GREENVILLE, TEXAS 75402, UNITED STATES OF AMERICA			
DATE OF REGISTRATION	06/03/2013		
TITLE	TOY		
PRIORITY			
PRIORITY NUMBER	DATE	COUNTRY	
29/432,774	20/09/2012	U.S.A.	
DESIGN NUMBER	247267		
CLASS	23-01		
1)JAIN IRRIGATION SYSTEMS LIMITED, HAVING ITS ADDRESS AT ‘‘JAIN PLASTIC PARK, N.H. NO. 6, BAMBHORI, JALGAON-425001, MAHARASHTRA, INDIA			
DATE OF REGISTRATION	21/08/2012		
TITLE	AIR RELEASE VALVE ASSEMBLY		
PRIORITY NA			
DESIGN NUMBER	252860		
CLASS	10-01		
1)AJANTA LIMITED, AN INDIAN COMPANY OF ORPAT INDUSTRIAL ESTATE, RAJKOT-MORBI HIGHWAY, MORBI 363641, STATE OF GUJARAT, INDIA			
DATE OF REGISTRATION	03/04/2013		
TITLE	CLOCK		
PRIORITY NA			

DESIGN NUMBER	254703	
CLASS	06-13	
1)SCI EXPORT (P) LTD., SITUATED AT WZ-NA-240, VISHNU GARDEN, NEW DELHI-110018 (INDIA) A COMPANY INCORPORATED UNDER THE INDIAN COMPANIES ACT, OF ABOVE ADDRESS		
DATE OF REGISTRATION	24/06/2013	
TITLE	SOFA BACK COVER	
PRIORITY NA		
DESIGN NUMBER	242241	
CLASS	12-16	
1)MR. SURESH RAMPRAKASH CHAWLA KARISMA NEST, ROW HOUSE NO. 8, MORWADI, PIMPRI, PUNE - 411018, MAHARASHTRA STATES, INDIA NATIONALITY:- INDIAN		
DATE OF REGISTRATION	13/01/2012	
TITLE	TOP MOUNTED SAFETY BOX IN SPARE WHEEL USED IN VEHICLE	
PRIORITY NA		
DESIGN NUMBER	248537	
CLASS	31-00	
1)SUJAN DHARNENDRABHAI SHAH, ADULT, INDIAN NATIONALITY, SOLE PROPRIETOR OF M/S. S S DESIGN, HAVING HIS ADDRESS AT 'PARITOSH'• , OPP. DHANANJAY TOWER, NEAR SHYAMAL 3/A, 100 FEET ROAD, SATELLITE, AHMEDABAD-380015, GUJARAT STATE, INDIA		
DATE OF REGISTRATION	04/10/2012	
TITLE	FOOD CART	
PRIORITY NA		

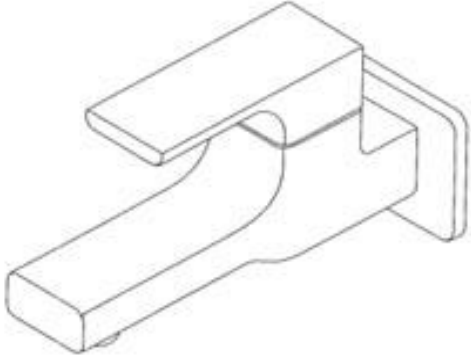
DESIGN NUMBER	252435	
CLASS	24-02	
1)DR. G. D. GUPTA, DIRECTOR, AMAR SAHEED BABA AJIT SINGH JUJHAR SINGH COLLEGE OF PHARMACY BELA, ROPAR PUNJAB, INDIA 140111, NATIONALITY INDIAN		
DATE OF REGISTRATION	19/03/2013	
TITLE	RECTAL INSERT	
PRIORITY NA		

DESIGN NUMBER	249371	
CLASS	23-01	
1)BEIJING KOHLER LTD., A CORPORATION ORGANIZED AND EXISTING UNDER THE LAWS OF CHINA, OF NO. 27 WEST GUO YUAN ROAD, BEIJING, MIYUN COUNTY 101500, CHINA P.R.		
DATE OF REGISTRATION	09/11/2012	
TITLE	WATER SPOUT	
PRIORITY		
PRIORITY NUMBER	DATE	COUNTRY
201230180855.9	11/05/2012	CHINA

DESIGN NUMBER	249437	
CLASS	12-16	
1)CONCENTRIC PUMPS PUNE PVT. LTD. A COMPANY REGISTERED UNDER COMPANY ACT 1956 OF GAT NO. 26/1, 27 & 28 (PART), OFF PUNE-NAGAR ROAD, VILLAGE LONIKAND, P.O. LONIKAND, TALUKA HAVELI, PUNE-412216, MAHARASHTRA, INDIA		
DATE OF REGISTRATION	12/11/2012	
TITLE	ENGINE COOLING WATER PUMP USED IN UTOMOBILE	
PRIORITY NA		

DESIGN NUMBER	249493		
CLASS	09-07		
1)PLASTICUM GROUP B.V. A DUTCH COMPANY OF THE ADDRESS: 9, ZEVENHEUVELENWEG, 5048 AN TILBURG, THE NETHERLANDS			
DATE OF REGISTRATION	15/11/2012		
TITLE	CAP FOR PACKAGING		
PRIORITY			
PRIORITY NUMBER	DATE	COUNTRY	
002041863-0003	15/05/2012	EUROPEAN UNION	
DESIGN NUMBER	252247		
CLASS	07-07		
1)M/S GAUTAM ENTERPRISES, 8347, NEW ANAJ MANDI, FILMISTAN, DELHI-110006, AN INDIAN PROPRIETORSHIP FIRM, WHOSE PROPRIETOR IS GAURAV JAIN, OF ABOVE ADDRESS, AN INDIAN NATIONAL			
DATE OF REGISTRATION	11/03/2013		
TITLE	BASKET		
PRIORITY NA			
DESIGN NUMBER	252324		
CLASS	23-01		
1)PRAKASHBHAI D. JARSANIYA., INDIAN NATIONALITY, SOLE PROPRIETOR OF M/S. ASHOK POLYMERS, INDIAN NATIONALITY, HAVING ADDRESS AT 4, SHREENATHJI ESTATE, NR. G.V.M.M., B/H. DEVBHUMI ESTATE, SINGARVA ROAD, ODHAV, AHMEDABAD-382430, GUJARAT STATE, INDIA			
DATE OF REGISTRATION	15/03/2013		
TITLE	SUCTION VALVE		
PRIORITY NA			

DESIGN NUMBER	252696	
CLASS	23-04	
1)HAVELLS INDIA LIMITED HAVING REGISTERED OFFICE AT 1, RAJ NARAIN MARG, CIVIL LINES, DELHI-110054.		
DATE OF REGISTRATION	28/03/2013	
TITLE	FAN	
PRIORITY NA		
DESIGN NUMBER	252779	
CLASS	08-08	
1)M/S J. K. INDUSTRIAL CORPORATION, HL-234, PHB COLONY, SUKHDEV NAGAR, JAMALPUR, FOCAL POINT, LUDHIANA-141010 (PUNJAB) INDIA AN INDIAN PROPRIETORSHIP FIRM WHOSE PROPRIETOR IS:- HARINDER PAL SINGH BEING INDIAN NATIONAL OF THE ABOVE ADDRESS		
DATE OF REGISTRATION	02/04/2013	
TITLE	BELT FASTNER	
PRIORITY NA		
DESIGN NUMBER	252858	
CLASS	15-01	
1)GREAVES COTTON LIMITED, AN INDIAN COMPANY OF INDUSTRY MANOR, APPASAHEB MARATHE MARG, PRABHADEVI, MUMBAI 400025, STATE OF MAHARASHTRA, INDIA		
DATE OF REGISTRATION	03/04/2013	
TITLE	ENGINE	
PRIORITY NA		

DESIGN NUMBER	248324		
CLASS	09-01		
1)PEPSICO, INC., INCORPORATED IN NORTH CAROLINA OF 700 ANDERSON HILL ROAD, PURCHASE, NEW YORK 10577, UNITED STATES OF AMERICA			
DATE OF REGISTRATION	03/10/2012		
TITLE	CARTRIDGE FOR BEVERAGE DISPENSER		
PRIORITY			
PRIORITY NUMBER	DATE	COUNTRY	
29/417, 436	03/04/2012	U.S.A.	
DESIGN NUMBER	252018		
CLASS	23-02		
1)HSIL LIMITED BAHADURGARH-124507, DT: JHAJJAR, HARYANA, INDIA, AN INDIAN COMPANY			
DATE OF REGISTRATION	04/03/2013		
TITLE	TOILET PAN		
PRIORITY NA			
DESIGN NUMBER	252097		
CLASS	28-02		
1)DINESH BASTIMAL JAIN (AN INDIAN NATIONAL) 203/204 RAJ MADHUR CHS. DEVIDAS LANE, NR. CLUB AQUERIA, BORIVALI (WEST) MUMBAI 400103, STATE OF MAHARASHTRA, INDIA			
DATE OF REGISTRATION	05/03/2013		
TITLE	EYE MASCARA		
PRIORITY NA			

DESIGN NUMBER	252183	
CLASS	09-07	
1)SANTEN PHARMACEUTICAL CO., LTD., OF 9-19, SHIMOSHINJO 3-CHOME, HIGASHIYODOGAWA-KU, OSAKA-SHI, OSAKA 5338651, JAPAN, A JAPANESE CORPORATION.		
DATE OF REGISTRATION	07/03/2013	
TITLE	CAP FOR PACKAGING CONTAINER	
PRIORITY		
PRIORITY NUMBER	DATE	COUNTRY
2012-021764	10/09/2012	JAPAN

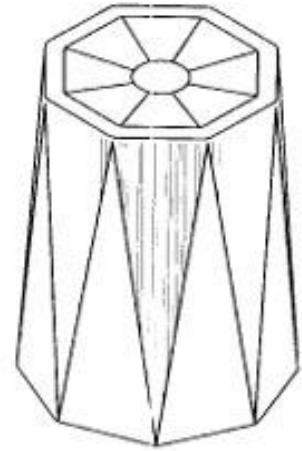



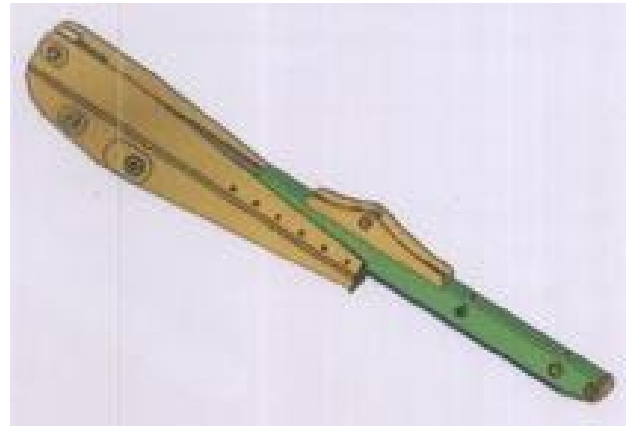

DESIGN NUMBER	251062	
CLASS	12-05	
1)M/S ESCORTS LTD., (A COMPANY INCORPORATED UNDER INDIAN COMPANIES ACT, 1956), 15/5, MATHURA ROAD, FARIDABAD-121003, HARYANA., (INDIA)		
DATE OF REGISTRATION	21/01/2013	
TITLE	EXTENDABLE DIPPER FOR BACKHOE LOADER	
PRIORITY NA		



DESIGN NUMBER	251828	
CLASS	23-02	
1)EURO-ANCHOR SANITARYWARE INDUSTRIES PVT LTD, A COMPANY INCORPORATED UNDER THE INDIAN COMPANIES ACT, HAVING ITS REGISTERED OFFICE AT OPP. JAMVALI BUS STOP, CHOTILA ROAD, THANGADH 363530, DIST: SURENDRANAGAR, GUJARAT, INDIA		
DATE OF REGISTRATION	22/02/2013	
TITLE	WATER CLOSET	
PRIORITY NA		

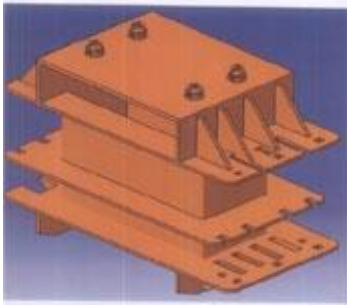

DESIGN NUMBER	253248	
CLASS	19-06	
1)ANCHOR ENTERPRISES PVT. LTD INNOVA 'C' WING, MARATHON NEXTGEN, OFF.G.K.MARG, LOWER PAREL (W), MUMBAI-400013 STATE OF MAHARASHTRA INDIA, / A PRIVATE LIMITED COMPANY INCORPORATED UNDER INDIAN COMPANIES ACT., ABOVE ADDRESS		
DATE OF REGISTRATION	19/04/2013	
TITLE	BALL POINT PEN	
PRIORITY NA		
DESIGN NUMBER	252548	
CLASS	02-03	
1)JSP LTD, A UK CORPORATION, WORSHAM MILL, MINSTER LOVELL, OXFORD, OX29 0TA, UNITED KINGDOM		
DATE OF REGISTRATION	20/03/2013	
TITLE	SAFETY HELMET	
PRIORITY NA		
DESIGN NUMBER	255570	
CLASS	19-06	
1)FLAIR PENS AND STATIONERY INDUSTRIES, AN INDIAN PARTNERSHIP FIRM OF 63, B/C, GOVT. INDUSTRIAL ESTATE, CHARKOP, KANDIVALI (W), MUMBAI - 400067, [MAHARASHTRA], INDIA; WHOSE PARTNERS ARE KHUBILAL J. RATHOD, RAJESH K. RATHOD, VIMALCHAND J. RATHOD, MOHIT K. RATHOD AND SUMIT V. RATHOD; ALL INDIANS OF THE ABOVE ADDRESS		
DATE OF REGISTRATION	31/07/2013	
TITLE	PEN	
PRIORITY NA		

DESIGN NUMBER	252317		
CLASS	15-06		
1)SU-KAM POWER SYSTEMS LTD. OF PLOT NO. WZ-1401/2, NANGAL RAYA, NEW DELHI-110 046, INDIA, AN INDIAN COMPANY			
DATE OF REGISTRATION	14/03/2013		
TITLE	SPLIT TYPE BOBBIN		
PRIORITY NA			
DESIGN NUMBER	252389		
CLASS	12-15		
1)EUROTIRE INC., OF 200 SOUTH BISCAYNE BOULEVARD, 55TH FLOOR, MIAMI, FLORIDA 33131, UNITED STATES OF AMERICA			
DATE OF REGISTRATION	18/03/2013		
TITLE	TIRE TREAD		
PRIORITY			
PRIORITY NUMBER	DATE	COUNTRY	
29/432,895	21/09/2012	U.S.A.	
DESIGN NUMBER	250440		
CLASS	14-03		
1)BOSE CORPORATION, A CORPORATION OF THE STATE OF DELAWARE, OF THE MOUNTAIN, MS40 FRAMINGHAM, MASSACHUSETTS 01701-9168, UNITED STATES OF AMERICA			
DATE OF REGISTRATION	24/12/2012		
TITLE	HEADPHONES SET		
PRIORITY			
PRIORITY NUMBER	DATE	COUNTRY	
29/426,761	10/07/2012	U.S.A.	

DESIGN NUMBER	252017	
CLASS	23-02	
1)HSIL LIMITED BAHADURGARH-124507, DT: JHAJJAR, HARYANA, INDIA, AN INDIAN COMPANY		
DATE OF REGISTRATION	04/03/2013	
TITLE	TOILET PAN	
PRIORITY NA		
DESIGN NUMBER	252088	
CLASS	28-02	
1)DINESH BASTIMAL JAIN (AN INDIAN NATIONAL) AT 203/204 RAJ MADHUR CHS. DEVIDAS LANE, NR. CLUB AQUERIA, BORIVALI (WEST) MUMBAI 400103, STATE OF MAHARASHTRA, INDIA		
DATE OF REGISTRATION	05/03/2013	
TITLE	BOTTLE FOR EYE LINEAR	
PRIORITY NA		
DESIGN NUMBER	252855	
CLASS	10-01	
1)AJANTA LIMITED, AN INDIAN COMPANY OF ORPAT INDUSTRIAL ESTATE, RAJKOT-MORBI HIGHWAY, MORBI 363641, STATE OF GUJARAT, INDIA		
DATE OF REGISTRATION	03/04/2013	
TITLE	CLOCK	
PRIORITY NA		

DESIGN NUMBER	252867	
CLASS	10-01	
1)AJANTA LIMITED, AN INDIAN COMPANY OF ORPAT INDUSTRIAL ESTATE, RAJKOT-MORBI HIGHWAY, MORBI 363641, STATE OF GUJARAT, INDIA		
DATE OF REGISTRATION	03/04/2013	
TITLE	CLOCK	
PRIORITY NA		

DESIGN NUMBER	252904	
CLASS	13-03	
1)ANCHOR ELECTRICALS PRIVATE LIMITED, AN INDIAN COMPANY OF STEEL HOUSE, B WING, PLOT NO. 24, MAHAL INDUSTRIAL ESTATE, MAHAKALI CAVES ROAD, NEAR PAPER BOX, ANDHERI (E), MUMBAI 400093, INDIA		
DATE OF REGISTRATION	04/04/2013	
TITLE	MINIATURE CIRCUIT BREAKER	
PRIORITY NA		

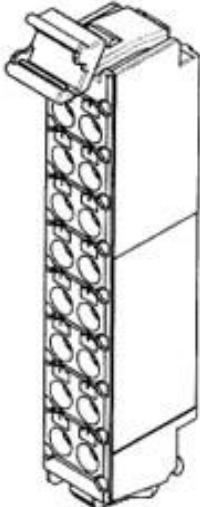
DESIGN NUMBER	252927	
CLASS	13-03	
1)OMRON CORPORATION, A CORPORATION ORGANIZED AND EXISTING UNDER THE LAWS OF JAPAN, OF 801, MINAMIFUDODO-CHO, HORIKAWAHIGASHIIRU, SHIOKOJI-DORI, SHIMOGYO-KU, KYOTO-SHI, KYOTO 600-8530, JAPAN		
DATE OF REGISTRATION	05/04/2013	
TITLE	TERMINAL BLOCK FOR CONNECTING ELECTRICAL WIRES	
PRIORITY		
PRIORITY NUMBER	DATE	COUNTRY
2012-24672	10/10/2012	JAPAN

DESIGN NUMBER	252963	
CLASS	14-03	
1)KABUSHIKI KAISHA TOSHIBA, A JAPANESE CORPORATION, MANUFACTURERS, OF 1-1, SHIBAURA 1-CHOME, MINATO-KU, TOKYO, JAPAN		
DATE OF REGISTRATION	09/04/2013	
TITLE	TELEVISION	
PRIORITY NA		

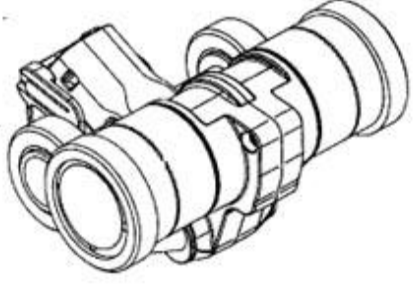
DESIGN NUMBER	253096	
CLASS	15-06	
1)MASCHINENFABRIK RIETER AG, A SWISS COMPANY OF KLOSTERSTRASSE 20, CH-8406 WINTERTHUR, SWITZERLAND		
DATE OF REGISTRATION	11/04/2013	
TITLE	CONDENSING MODULE FOR SPINNING MACHINE	
PRIORITY		
PRIORITY NUMBER	DATE	COUNTRY
201230534461.9	12/10/2012	CHINA

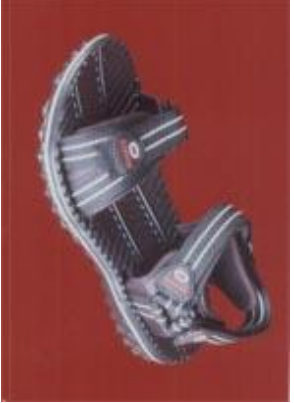
DESIGN NUMBER	254355	
CLASS	02-04	
1)AMBIKA FOOTWEAR PVT. LTD. C-48/2, LAWRENCE ROAD INDUSTRIAL AREA, DELHI-110035, INDIA (AN INDIAN COMPANY DULY REGISTERED UNDER THE COMPANIES ACT, 1956)		
DATE OF REGISTRATION	06/06/2013	
TITLE	FOOTWEAR	
PRIORITY NA		

DESIGN NUMBER	251793	
CLASS	21-02	
1)MIRIK RAJENDRA GOGRI, INDIAN NATIONAL, 1401, ANTRIKSH TOWER, MURAR ROAD, MULUND (W), MUMBAI-400 080, MAHARASHTRA, INDIA.		
DATE OF REGISTRATION	20/02/2013	
TITLE	BAT	
PRIORITY NA		
DESIGN NUMBER	251885	
CLASS	13-03	
1)LARSEN & TOUBRO LIMITED, AN INDIAN COMPANY INCORPORATED UNDER THE COMPANIES ACT, 1956 OF L & T HOUSE, BALLARD ESTATE, MUMBAI 400001, STATE OF MAHARASHTRA, INDIA		
DATE OF REGISTRATION	26/02/2013	
TITLE	MOULDED CASE CIRCUIT BREAKER	
PRIORITY NA		
DESIGN NUMBER	234785	
CLASS	24-04	
1)WILLIAM THOMAS MISTLER 506 WILDFLOWER LANE, MEDIA, PENNSYLVANIA 19063, USA		
DATE OF REGISTRATION	25/02/2011	
TITLE	FAMILY PLANNING DEVICE	
PRIORITY NA		

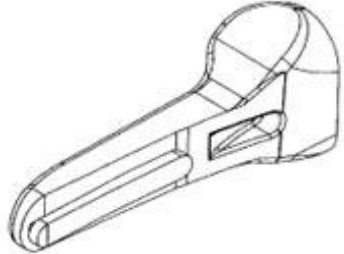
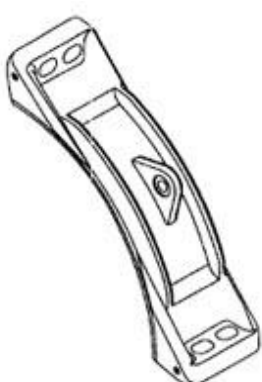
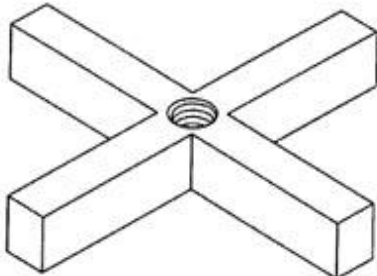
DESIGN NUMBER	252621		
CLASS	24-02		
1)SCALPAL LLC, A DELAWARE CORPORATION, C/O MR. ELIYAHU GITMAN, BUILDING 66, APT. 1, RAMAT POLIN, JERUSALEM 97290, ISRAEL			
DATE OF REGISTRATION	22/03/2013		
TITLE	SCALPEL TIP		
PRIORITY			
DESIGN NUMBER	252665		
CLASS	23-01		
1)VICTAULIC COMPANY, A CORPORATION OF THE STATE OF NEW JERSEY, HAVING A PLACE OF BUSINESS AT 4901 KESSLERSVILLE ROAD, EASTON, PENNSYLVANIA 18040, UNITED STATES OF AMERICA			
DATE OF REGISTRATION	26/03/2013		
TITLE	PIPE COUPLING SEGMENT		
PRIORITY			
PRIORITY NUMBER	DATE	COUNTRY	
29/433,534	01/10/2012	U.S.A.	
DESIGN NUMBER	251384		
CLASS	08-08		
1)OOPARTS, INC., NATIONALITY: JAPAN ADDRESS AT 1643-28, SHUKU, SOJA-SHI, OKAYAMA 719-1161 JAPAN			
DATE OF REGISTRATION	04/02/2013		
TITLE	BASE MEMBER OF FASTENING DEVICE		
PRIORITY NA			

DESIGN NUMBER	252012	
CLASS	26-02	
1)KONINKLIJKE PHILIPS ELECTRONICS N.V., A COMPANY ORGANIZED AND EXISTING UNDER THE LAWS OF THE KINGDOM OF THE NETHERLANDS, RESIDING AT EINDHOVEN, WHOSE POST-OFFICE ADDRESS IS HIGH TECH CAMPUS 5, 5656 AE EINDHOVEN, THE NETHERLANDS		
DATE OF REGISTRATION	04/03/2013	
TITLE	PORTABLE LAMP	
PRIORITY		
PRIORITY NUMBER	DATE	COUNTRY
002096834-0001	04/09/2012	OHIM



DESIGN NUMBER	252172	
CLASS	12-08	
1)DR. ING. H.C.F. PORSCHE AKTIENGESELLSCHAFT, A GERMAN COMPANY OF PORSCHEPLATZ 1, 70435 STUTTGART, GERMANY		
DATE OF REGISTRATION	07/03/2013	
TITLE	CAR	
PRIORITY NA		





DESIGN NUMBER	238079	
CLASS	12-15	
1)SUMITOMO RUBBER INDUSTRIES LTD 6-9 WAKINOHAMA-CHO, 3-CHOME CHUO -KU KOBE -SHI HYOGO 651-0072 JAPAN,		
DATE OF REGISTRATION	15/07/2011	
TITLE	TIRE	
PRIORITY NA		

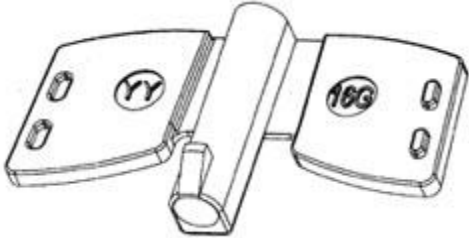

DESIGN NUMBER	252688		
CLASS	09-07		
1)APTARGROUP, INC., 475 WEST TERRA COTTA, SUITE E, CRYSTAL LAKE, ILLINOIS 60014-9695, UNITED STATES OF AMERICA, A DELAWARE CORPORATION			
DATE OF REGISTRATION	26/03/2013		
TITLE	DISPENSING CLOSURE		
PRIORITY			
PRIORITY NUMBER	DATE	COUNTRY	
29/433,219	27/09/2012	U.S.A.	
DESIGN NUMBER	252772		
CLASS	09-03		
1)WILLOWOOD CROP SCIENCES PVT. LTD., A COMPANY INCORPORATED UNDER THE COMPANIES ACT, 1956 OF THE ADDRESS 409, FOURTH FLOOR, SALCON AURUM, DISTRICT CENTRE, JASOLA, NEW DELHI-110025, INDIA			
DATE OF REGISTRATION	02/04/2013		
TITLE	CARTON FOR PACKAGING		
PRIORITY NA			
DESIGN NUMBER	252822		
CLASS	15-09		
1)RELIANCE INDUSTRIES LIMITED, A COMPANY INCORPORATED UNDER THE INDIAN COMPANIES ACT, AT 3RD FLOOR, MAKER CHAMBERS IV, 222, NARIMAN POINT, MUMBAI-400021, MAHARASHTRA, INDIA			
DATE OF REGISTRATION	03/04/2013		
TITLE	STIRRER		
PRIORITY NA			

DESIGN NUMBER	252864	
CLASS	10-01	
1)AJANTA LIMITED, AN INDIAN COMPANY OF ORPAT INDUSTRIAL ESTATE, RAJKOT-MORBI HIGHWAY, MORBI 363641, STATE OF GUJARAT, INDIA		
DATE OF REGISTRATION	03/04/2013	
TITLE	CLOCK	
PRIORITY NA		

DESIGN NUMBER	252896	
CLASS	24-02	
1)POLY MEDICURE LIMITED, AN INDIAN COMPANY, OF PLOT NO. 105, SECTOR 59, HSIIDC INDUSTRIAL AREA, FARIDABAD, HARYANA-121004, INDIA		
DATE OF REGISTRATION	04/04/2013	
TITLE	WING OF FISTULA NEEDLE SET	
PRIORITY NA		

DESIGN NUMBER	254474	
CLASS	12-16	
1)AUDI AG, A JOINT STOCK COMPANY ESTABLISHED UNDER GERMAN LAW, OF 85045 INGOLSTADT, GERMANY		
DATE OF REGISTRATION	13/06/2013	
TITLE	WHEEL RIM	
PRIORITY		
PRIORITY NUMBER	DATE	COUNTRY
002153528-0002	14/12/2012	OHIM

DESIGN NUMBER	250239		
CLASS	15-04		
1)M/S. CATERPILLAR INC.; AN AMERICAN CORPORATION, OF THE ADDRESS 100 NE ADAMS STREET, PEORIA, IL 61269, UNITED STATES OF AMERICA			
DATE OF REGISTRATION	17/12/2012		
TITLE	CHAIN OF TRACK LINKS FOR MOBILE EARTHMOVING MACHINE		
PRIORITY			
PRIORITY NUMBER	DATE	COUNTRY	
29/426,089	29/06/2012	U.S.A.	
DESIGN NUMBER			
251909			
CLASS	23-04		
1)RECKITT & COLMAN (OVERSEAS) LIMITED, A BRITISH COMPANY OF 103-105 BATH ROAD, SLOUGH BERKSHIRE, SL1 3UH, UNITED KINGDOM			
DATE OF REGISTRATION	27/02/2013		
TITLE	INSECT REPELLENT DEVICE		
PRIORITY			
PRIORITY NUMBER	DATE	COUNTRY	
002093369-0001	28/08/2012	OHIM	
DESIGN NUMBER			
253334			
CLASS	19-06		
1)ANCHOR ENTERPRISES PVT. LTD INNOVA 'C' WING, MARATHON NEXTGEN, OFF.G.K.MARG, LOWER PAREL (W), MUMBAI-400013 STATE OF MAHARASHTRA INDIA, / A PRIVATE LIMITED COMPANY INCORPORATED UNDER INDIAN COMPANIES ACT., ABOVE ADDRESS			
DATE OF REGISTRATION	23/04/2013		
TITLE	BALL POINT PEN		
PRIORITY NA			

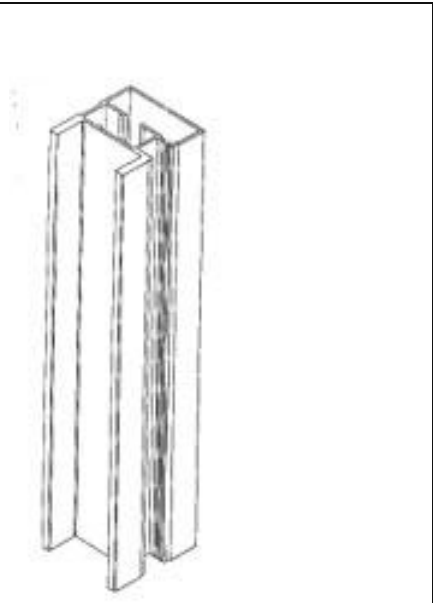

DESIGN NUMBER	250067	
CLASS	08-09	
1)RAUMPLUS BESITZ-UND ENTWICKLUNGS-GMBH & CO. KG, DORTMUNDER STRASSE 35, 28199 BREMEN, GERMANY		
DATE OF REGISTRATION	11/12/2012	
TITLE	FITTINGS FOR DOORS, WINDOWS OR FURNITURE	
PRIORITY NA		

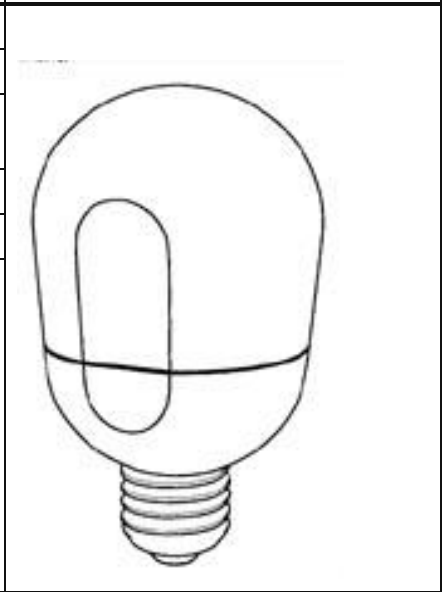

DESIGN NUMBER	252616	
CLASS	26-04	
1)LIGHTLAB SWEDEN AB, A SWEDISH COMPANY, OF ÖSTERMALMSTORG 1, 114 42 STOCKHOLM, SWEDEN		
DATE OF REGISTRATION	22/03/2013	
TITLE	FIELD EMISSION LAMP	
PRIORITY		
PRIORITY NUMBER	DATE	COUNTRY
001344824	26/09/2012	OHIM

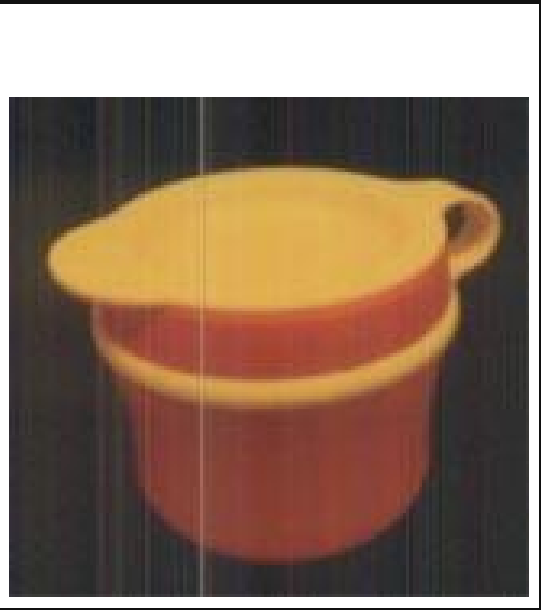

DESIGN NUMBER	251458	
CLASS	07-01	
1)DART INDUSTRIES INC., A CORPORATION FOUNDED UNDER THE LAWS OF DELAWARE, U.S.A. OF 14901 SOUTH ORANGE BLOSSOM TRAIL, ORLANDO, FLORIDA 32837, USA		
DATE OF REGISTRATION	06/02/2013	
TITLE	CUP WITH COVER	
PRIORITY		
PRIORITY NUMBER	DATE	COUNTRY
29/421,658	28/08/2012	U.S.A.

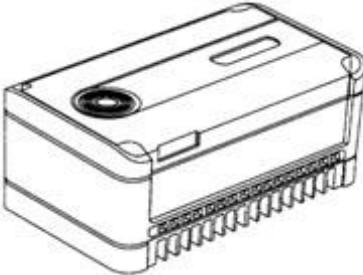

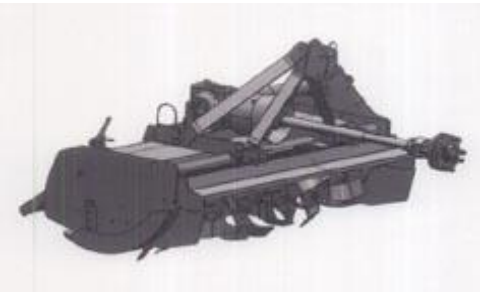
DESIGN NUMBER	246664		
CLASS	12-16		
1)MITSUBA CORPORATION, A JAPANESE CORPORATION, WHOSE ADDRESS IS 2681, HIROSAWACHO 1-CHOME, KIRYU-SHI, GUNMA 376-85555, JAPAN			
DATE OF REGISTRATION	23/07/2012		
TITLE	WINDSHIELD WIPER FOR VEHICLE		
PRIORITY NA			
DESIGN NUMBER	249439		
CLASS	12-16		
1)CONCENTRIC PUMPS PUNE PVT. LTD. A COMPANY REGISTERED UNDER COMPANY ACT 1956 OF GAT NO. 26/1, 27 & 28 (PART), OFF PUNE-NAGAR ROAD, VILLAGE LONIKAND, P.O. LONIKAND, TALUKA HAVELI, PUNE-412216, MAHARASHTRA, INDIA			
DATE OF REGISTRATION	12/11/2012		
TITLE	LUBRICATING OIL PUMP USED IN AUTOMOBILE		
PRIORITY NA			
DESIGN NUMBER	249497		
CLASS	13-03		
1)GE INTELLIGENT PLATFORMS, INC, A DELAWARE CORPORATION ORGANIZED UNDER THE LAWS OF UNITED STATES OF AMERICA HAVING ITS OFFICE AT 2500, AUSTIN DRIVE, CHARLOTTESVILLE VA 22911, UNITED STATES OF AMERICA			
DATE OF REGISTRATION	15/11/2012		
TITLE	ENCLOSURE FOR ELECTRONICS COMPONENTS		
PRIORITY			
PRIORITY NUMBER	DATE	COUNTRY	
29/422,058	16/05/2012	U.S.A.	

DESIGN NUMBER	252372	
CLASS	15-03	
1)HMT LIMITED, TRACTOR DIVISION, PINJORE-134101, DISTT: PANCHKULA (HARYANA) INDIA		
DATE OF REGISTRATION	18/03/2013	
TITLE	ROTAVATOR	
PRIORITY NA		
DESIGN NUMBER	252854	
CLASS	10-01	
1)AJANTA LIMITED, AN INDIAN COMPANY OF ORPAT INDUSTRIAL ESTATE, RAJKOT-MORBI HIGHWAY, MORBI 363641, STATE OF GUJARAT, INDIA		
DATE OF REGISTRATION	03/04/2013	
TITLE	CLOCK	
PRIORITY NA		
DESIGN NUMBER	252866	
CLASS	10-01	
1)AJANTA LIMITED, AN INDIAN COMPANY OF ORPAT INDUSTRIAL ESTATE, RAJKOT-MORBI HIGHWAY, MORBI 363641, STATE OF GUJARAT, INDIA		
DATE OF REGISTRATION	03/04/2013	
TITLE	CLOCK	
PRIORITY NA		

DESIGN NUMBER	252903	
CLASS	13-03	
1)ANCHOR ELECTRICALS PRIVATE LIMITED, AN INDIAN COMPANY OF STEEL HOUSE, B WING, PLOT NO. 24, MAHAL INDUSTRIAL ESTATE, MAHAKALI CAVES ROAD, NEAR PAPER BOX, ANDHERI (E), MUMBAI 400 093, INDIA		
DATE OF REGISTRATION	04/04/2013	
TITLE	MINIATURE CIRCUIT BREAKER	
PRIORITY NA		
DESIGN NUMBER	252015	
CLASS	23-02	
1)HSIL LIMITED BAHADURGARH-124507, DT: JHAJJAR, HARYANA, INDIA, AN INDIAN COMPANY		
DATE OF REGISTRATION	04/03/2013	
TITLE	URINAL POT	
PRIORITY NA		
DESIGN NUMBER	251110	
CLASS	28-03	
1)LASER SHAVING (INDIA) PRIVATE LIMITED, A COMPANY DULY ORGANIZED UNDER THE INDIAN COMPANIES ACT, 1956 AND HAVING ITS REGISTERED OFFICE AT MALHOTRA HOUSE, 6-3-1186, BEGUMPET, HYDERABAD 500016, ANDHRA PRADESH, INDIA.		
DATE OF REGISTRATION	22/01/2013	
TITLE	RAZOR HANDLE	
PRIORITY NA		

DESIGN NUMBER	254476	
CLASS	12-16	
1)AUDI AG, A JOINT STOCK COMPANY ESTABLISHED UNDER GERMAN LAW, OF 85045 INGOLSTADT, GERMANY		
DATE OF REGISTRATION	13/06/2013	
TITLE	WHEEL RIM	
PRIORITY		
PRIORITY NUMBER	DATE	COUNTRY
002153528-0004	14/12/2012	OHIM





DESIGN NUMBER	250291	
CLASS	12-16	
1)TREND EAST YUGEN KAISHA, OF FAMILE NARIMASU GRANDAGE NO. 104, 32-22, ASAHICYO 3- CHOME, NERIMA-KU, TOKYO, JAPAN, A JAPANESE COMPANY		
DATE OF REGISTRATION	18/12/2012	
TITLE	WIPER FOR AUTOMOBILE	
PRIORITY		
PRIORITY NUMBER	DATE	COUNTRY
15959/2012	05/07/2012	JAPAN



DESIGN NUMBER	251883	
CLASS	13-03	
1)LARSEN & TOUBRO LIMITED, AN INDIAN COMPANY INCORPORATED UNDER THE COMPANIES ACT, 1956 OF L & T HOUSE, BALLARD ESTATE, MUMBAI 400001, STATE OF MAHARASHTRA, INDIA		
DATE OF REGISTRATION	26/02/2013	
TITLE	MOULDED CASE CIRCUIT BREAKER	
PRIORITY NA		

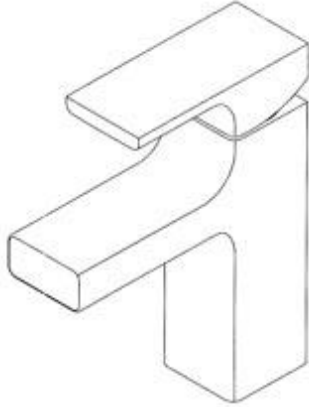
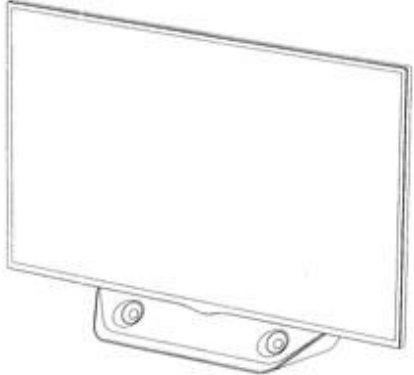

DESIGN NUMBER	252486		
CLASS	15-02		
1)CROMPTON GREAVES LIMITED, (AN INDIAN COMPANY), AVANTHA HOUSE, 6TH FLOOR, DR. ANNIE BESANT ROAD, WORLI, MUMBAI-400030, MAHARASHTRA, INDIA			
DATE OF REGISTRATION	20/03/2013		
TITLE	MONOSET PUMP		
PRIORITY NA			
DESIGN NUMBER	249354		
CLASS	23-01		
1)BEIJING KOHLER LTD., A CORPORATION ORGANIZED AND EXISTING UNDER THE LAWS OF CHINA, OF NO. 27 WEST GUO YUAN ROAD, BEIJING, MIYUN COUNTY 101500, CHINA P.R.			
DATE OF REGISTRATION	09/11/2012		
TITLE	FAUCET		
PRIORITY			
PRIORITY NUMBER	DATE	COUNTRY	
201230180853.X	11/05/2012	CHINA	
DESIGN NUMBER	252383		
CLASS	14-03		
1)LG ELECTRONICS INC., 20 YEOUIDO-DONG YEONGDEUNGPO - GU SEOUL, 150-721 REPUBLIC OF KOREA, A CORPORATION INCORPORATED UNDER THE LAWS OF THE REPUBLIC OF KOREA			
DATE OF REGISTRATION	18/03/2013		
TITLE	TELEVISION RECEIVER		
PRIORITY			
PRIORITY NUMBER	DATE	COUNTRY	
30-2013-0009374	22/02/2013	REPUBLIC OF KOREA	

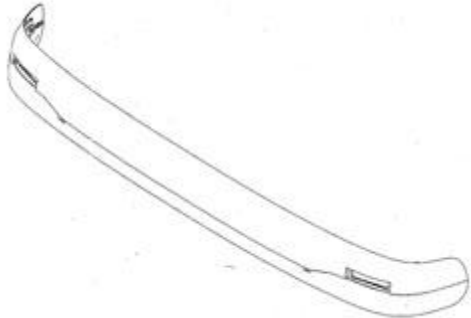
DESIGN NUMBER	247236		
CLASS	09-01		
1)THE COCA-COLA COMPANY, A CORPORATION ORGANIZED AND EXISTING UNDER THE LAWS OF THE STATE OF DELAWARE HAVING AN OFFICE AT ONE COCA-COLA PLAZA NW, ATLANTA, GEORGIA 30313, USA			
DATE OF REGISTRATION	17/08/2012		
TITLE	BOTTLE		
PRIORITY			
PRIORITY NUMBER	DATE	COUNTRY	
29/413,665	17/02/2012	U.S.A.	
DESIGN NUMBER	250931		
CLASS	23-01		
1)A. N. POLYMERS PRIVATE LIMITED, INDIA. A COMPANY INCORPORATED IN INDIA UNDER THE COMPANIES ACT, 1956 AT A-54, NARAINA INDUSTRIAL AREA, PHASE-I, NEW DELHI-110028 (INDIA)			
DATE OF REGISTRATION	10/01/2013		
TITLE	WATER PURIFIER		
PRIORITY NA			
DESIGN NUMBER	252792		
CLASS	12-16		
1)SCANIA CV AB, SE-151 87, SÖDERTÄLJE, SWEDEN			
DATE OF REGISTRATION	03/04/2013		
TITLE	SUN VISOR FOR VEHICLE		
PRIORITY			
PRIORITY NUMBER	DATE	COUNTRY	
2012/0436	04/10/2012	SWEDEN	

DESIGN NUMBER	252859	
CLASS	10-01	
1)AJANTA LIMITED, AN INDIAN COMPANY OF ORPAT INDUSTRIAL ESTATE, RAJKOT-MORBI HIGHWAY, MORBI 363641, STATE OF GUJARAT, INDIA		
DATE OF REGISTRATION	03/04/2013	
TITLE	CLOCK	
PRIORITY NA		
DESIGN NUMBER	252883	
CLASS	15-01	
1)GREAVES COTTON LIMITED, AN INDIAN COMPANY OF INDUSTRY MANOR, APPASAHEB MARATHE MARG, PRABHADEVI, MUMBAI 400025, STATE OF MAHARASHTRA, INDIA		
DATE OF REGISTRATION	03/04/2013	
TITLE	ENGINE	
PRIORITY NA		
DESIGN NUMBER	251985	
CLASS	12-11	
1)BAJAJ AUTO LIMITED, AN INDIAN COMPANY, INCORPORATED UNDER THE COMPANIES ACT OF 1956, HAVING ITS PRINCIPAL PLACE OF BUSINESS AT NEW 2ND & 3RD FLOOR, KHIVRAJ BUILDING, NO. 616, ANNASALAI, CHENNAI - 600006, STATE OF TAMIL NADU, INDIA, AND REGISTERED OFFICE AT AKURDI, PUNE-411035, STATE OF MAHARASHTRA, INDIA		
DATE OF REGISTRATION	01/03/2013	
TITLE	FAIRING ASSEMBLY FOR MOTORCYCLE	
PRIORITY NA		

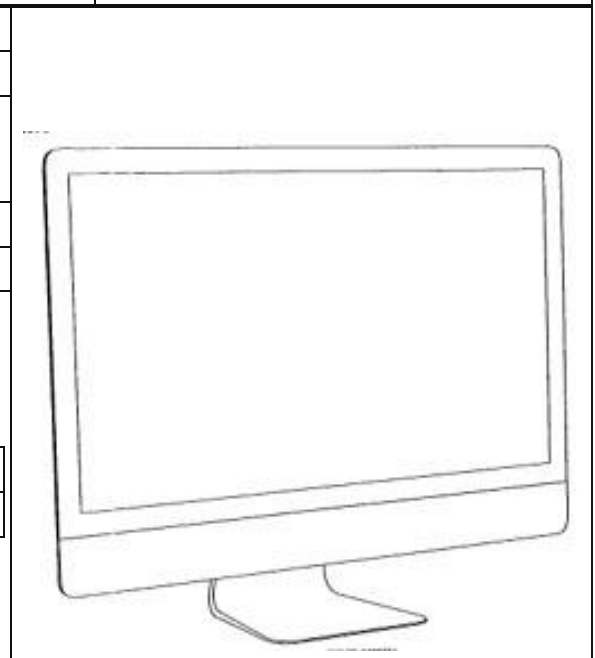

DESIGN NUMBER	252099	
CLASS	09-01	
1)DINESH BASTIMAL JAIN (AN INDIAN NATIONAL) AT 203/204 RAJ MADHUR CHS. DEVIDAS LANE, NR. CLUB AQUERIA, BORIVALI (WEST) MUMBAI 400103, STATE OF MAHARASHTRA, INDIA		
DATE OF REGISTRATION	05/03/2013	
TITLE	PERFUME BOTTLE	
PRIORITY NA		

DESIGN NUMBER	252190	
CLASS	14-02	
1)APPLE INC., 1 INFINITE LOOP, CUPERTINO, CA 95014, U.S.A. A CORPORATION INCORPORATED IN THE STATE OF CALIFORNIA		
DATE OF REGISTRATION	07/03/2013	
TITLE	DESKTOP COMPUTER MONITOR	
PRIORITY		
PRIORITY NUMBER	DATE	COUNTRY
29/431,443	07/09/2012	U.S.A.



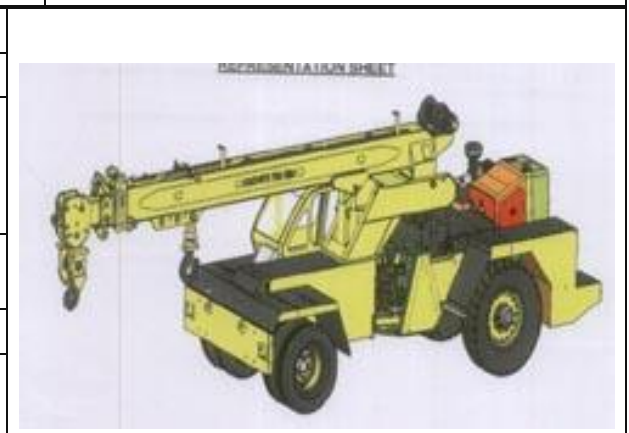

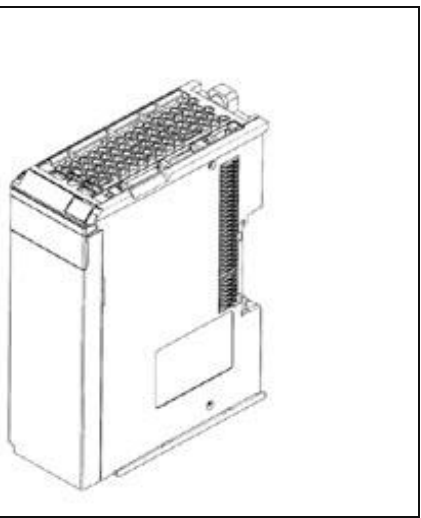
DESIGN NUMBER	251063
CLASS	12-05
1)M/S ESCORTS LTD., (A COMPANY INCORPORATED UNDER INDIAN COMPANIES ACT, 1956), 15/5, MATHURA ROAD, FARIDABAD-121003, HARYANA., (INDIA)	
DATE OF REGISTRATION	21/01/2013
TITLE	CRANE
PRIORITY NA	



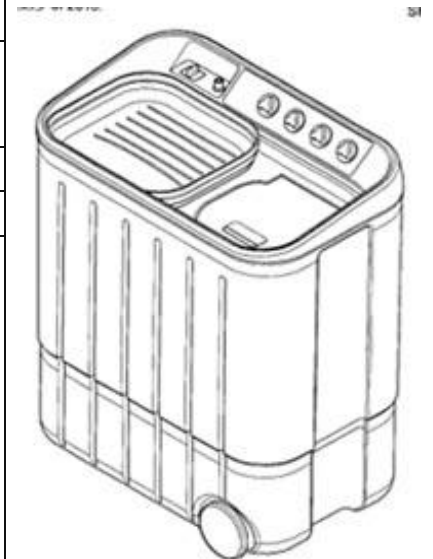

DESIGN NUMBER	252930		
CLASS	10-05		
1)OMRON CORPORATION, A CORPORATION ORGANIZED AND EXISTING UNDER THE LAWS OF JAPAN, OF 801, MINAMIFUDODO-CHO, HORIKAWAHIGASHIRU, SHIOKOJI-DORI, SHIMOGYO-KU, KYOTO-SHI, KYOTO 600-8530, JAPAN			
DATE OF REGISTRATION	05/04/2013		
TITLE	INPUT-OUTPUT UNIT FOR A PROGRAMMABLE CONTROLLER SYSTEM		
PRIORITY			
PRIORITY NUMBER	DATE	COUNTRY	
2012-24632	10/10/2012	JAPAN	
DESIGN NUMBER	254375		
CLASS	10-04		
1)KETT ELECTRIC LABORATORY, A JAPANESE COMPANY OF 1-8-1, MINAMI-MAGOME, OTA-KU, TOKYO 143-8507, JAPAN			
DATE OF REGISTRATION	06/06/2013		
TITLE	MOISTURE TESTER		
PRIORITY NA			
DESIGN NUMBER	242240		
CLASS	12-16		
1)MR. SURESH RAMPRAKASH CHAWLA KARISMA NEST, ROW HOUSE NO.-8, MORWADI, PIMPRI, PUNE - 411018, MAHARASHTRA STATES, INDIA			
DATE OF REGISTRATION	13/01/2012		
TITLE	BOTTOM MOUNTED SAFETY BOX IN SPARE WHEEL USED IN VEHICLE		
PRIORITY NA			
			

DESIGN NUMBER	251726	
CLASS	13-03	
1) LARSEN & TOUBRO LIMITED, AN INDIAN COMPANY INCORPORATED UNDER THE COMPANIES ACT, 1956 OF L & T HOUSE, BALLARD ESTATE, MUMBAI 400001, STATE OF MAHARASHTRA, INDIA		
DATE OF REGISTRATION	18/02/2013	
TITLE	MOULDED CASE CIRCUIT BREAKER	
PRIORITY NA		
DESIGN NUMBER	254839	
CLASS	12-11	
1) BAJAJ AUTO LIMITED, AN INDIAN COMPANY, INCORPORATED UNDER THE COMPANIES ACT OF 1956, HAVING ITS PRINCIPAL PLACE OF BUSINESS AT NEW 2ND & 3RD FLOOR, KHIVRAJ BUILDING, NO. 616, ANNASALAI, CHENNAI - 600006, STATE OF TAMIL NADU, INDIA, AND REGISTERED OFFICE AT AKURDI, PUNE-411035, STATE OF MAHARASHTRA, INDIA		
DATE OF REGISTRATION	27/06/2013	
TITLE	HUGGER FOR MOTORCYCLE	
PRIORITY NA		
DESIGN NUMBER	252553	
CLASS	15-05	
1) SAMSUNG ELECTRONICS CO., LTD., A KOREAN COMPANY, OF 129, SAMSUNG-RO, YEONGTONG-GU, SUWON-SI, GYEONGGI-DO, 443-742, REPUBLIC OF KOREA		
DATE OF REGISTRATION	20/03/2013	
TITLE	WASHING MACHINE	
PRIORITY		
PRIORITY NUMBER	DATE	COUNTRY
30-2012-0046879	28/09/2012	REPUBLIC OF KOREA

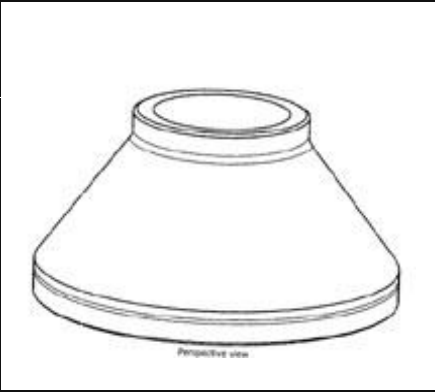
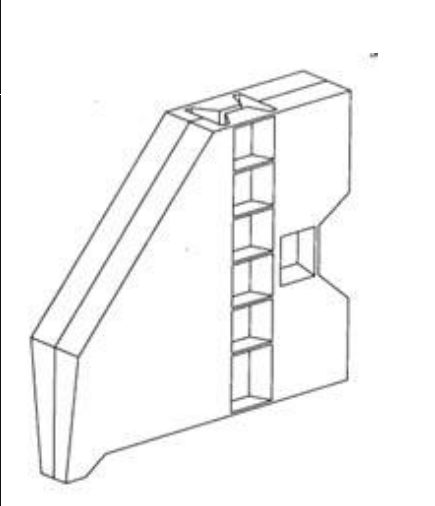

DESIGN NUMBER	252575		
CLASS	08-06		
1)(1) PARESHBHAI V. BHALIYA (2) CHANDRIKABEN P. BHALIYA (3) RAJESH O. KOTADIA (4) GHANSHYAM O. KOTADIA ALL INDIAN NATIONAL PARTNERS OF MARUTI METALS AN INDIAN PARTNERSHIP FIRM HAVING ITS PRINCIPAL PLACE OF BUSINESS AT			
SOMNATH ESTATE, SHOP NO. 3, NEAR DWARKADHISH ESTATE, VIRANI AGHAT, DHEBAR ROAD(SOUTH), RAJKOT-2, GUJARAT-INDIA			
DATE OF REGISTRATION	21/03/2013		
TITLE	HANDLE		
PRIORITY NA			
DESIGN NUMBER	250032		
CLASS	15-09		
1)SANDVIK INTELLECTUAL PROPERTY AB, OF			
SE-811 81 SANDVIKEN, SWEDEN, A SWEDISH COMPANY			
DATE OF REGISTRATION	07/12/2012		
TITLE	CRUSHING HEAD FOR CRUSHER		
PRIORITY			
PRIORITY NUMBER	DATE	COUNTRY	
001333785-0001	09/07/2012	OHIM	
DESIGN NUMBER	251545		
CLASS	26-02		
1)SABIC INNOVATIVE PLASTICS IP B.V., OF THE ADDRESS			
PLASTICSLAAN 1, 4612 PX BERGEN OP ZOOM, THE NETHERLANDS			
DATE OF REGISTRATION	11/02/2013		
TITLE	ROAD BARRIER UNIT		
PRIORITY			
PRIORITY NUMBER	DATE	COUNTRY	
29/429,580	14/08/2012	U.S.A.	

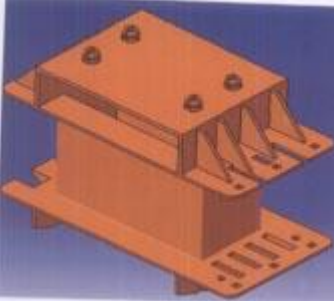
DESIGN NUMBER	251691		
CLASS	23-01		
1)S.P.M. FLOW CONTROL, INC., A CORPORATION ORGANIZED UNDER THE LAWS OF THE STATE OF TEXAS, U.S.A., 7601 WYATT DRIVE, FORT WORTH, TEXAS 76108			
DATE OF REGISTRATION	15/02/2013		
TITLE	SIDE SEAL SEGMENT FOR PLUG VALVE		
PRIORITY			
PRIORITY NUMBER	DATE	COUNTRY	
29/429,809	16/08/2012	U.S.A.	
DESIGN NUMBER	252227		
CLASS	03-04		
1)M/S. ORIENT FANS, PROP: ORIENT PAPER & INDUSTRIES LTD., 11, INDUSTRIAL ESTATE, SECTOR-6, FARIDABAD, HARYANA-121006			
DATE OF REGISTRATION	08/03/2013		
TITLE	CEILING FAN		
PRIORITY NA			
DESIGN NUMBER	252318		
CLASS	15-06		
1)SU-KAM POWER SYSTEMS LTD. OF PLOT NO. WZ-1401/2, NANGAL RAYA, NEW DELHI-110046, INDIA, AN INDIAN COMPANY			
DATE OF REGISTRATION	14/03/2013		
TITLE	NON SPLIT TYPE BOBBIN		
PRIORITY NA			