



## ***CONTINUED FROM PART- 1***

### **INTRODUCTION**

In view of the recent amendment made in the Designs (Amendment) Rules, 2008 with effect from 17/06/2008, Publication of the matter relating to Designs is being published in the Official Journal of The Patent Office. This Journal is being published on weekly basis on every Friday covering the various proceedings on Designs as required according to the provisions of under Rule 22, 25, 27 and 39 of the Design (Amendment) Rules, 2008. All the enquiries on this Official Journal and other information as required by the public should be addressed to the Controller General of Patents, Designs & Trade Marks. Suggestions and comments are requested from all quarters so that the content can be enriched.

## REGISTRATION OF DESIGNS

The following designs have been registered. They are now open for public inspection. In the following each entry the Date of Registration is shown. The Priority Number, Priority Date and Priority Country are also shown

<b>Design Number</b>	221052	
<b>Class</b>	08-07	
<b>1)E-Square Alliance (P) Ltd., 512, New Delhi House, Bara Khamba Road, New Delhi-110001, India.</b>		
<b>Date of Registration</b>	02/02/2009	
<b>Title</b>	Hasp	
<b>Priority NA</b>		
<b>Design Number</b>	221053	
<b>Class</b>	08-07	
<b>1)E-Square Alliance (P) Ltd., 512, New Delhi House, Bara Khamba Road, New Delhi-110001, India.</b>		
<b>Date of Registration</b>	02/02/2009	
<b>Title</b>	Hasp	
<b>Priority NA</b>		
<b>Design Number</b>	221162	
<b>Class</b>	23-02	
<b>1)Hindustan Sanitaryware &amp; Industries Limited, Bahadurgarh-124507, Haryana, India.</b>		
<b>Date of Registration</b>	12/02/2009	
<b>Title</b>	Cistern	
<b>Priority NA</b>		

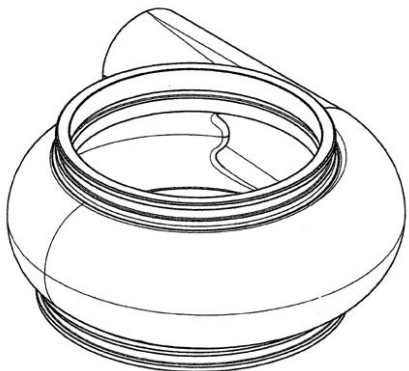
<b>Design Number</b>	221193		
<b>Class</b>	15-02		
<b>1)Weir Minerals Australia Ltd.,</b> 1 Marden Street, Artarmon, New South Wales 2064, Australia.			
<b>Date of Registration</b>	13/02/2009		
<b>Title</b>	Pump Liner		
<b>Priority</b>			
Priority Number	Date	Country	
13909/2008	14/08/2008	Australia	

<b>Design Number</b>	219149		
<b>Class</b>	12-16		
<b>1)Minda Industries Ltd.,</b> Vill Nawada Fatepur, P.O. Sikandepur Badda, Manesar, Distt. Gurgaon, Haryana-122004, India			
<b>Date of Registration</b>	14/10/2008		
<b>Title</b>	Illuminated Handle-Bar Grip With Rigid End		
<b>Priority NA</b>			

<b>Design Number</b>	221536		
<b>Class</b>	21-01		
<b>1)Anindita Toy Company Private Limited</b> SC 1/12, Kohinoor Estate, Behind Kamal Nayan Bajaj Udyan, Mumbai-Pune Road, Pune-411003, Maharashtra, India			
<b>Date of Registration</b>	06/03/2009		
<b>Title</b>	"Toy Set"		
<b>Priority NA</b>			

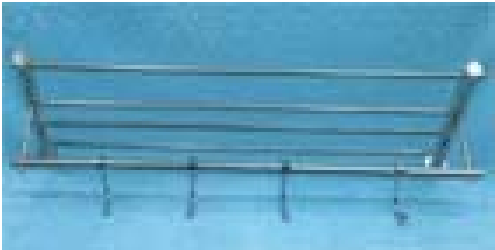
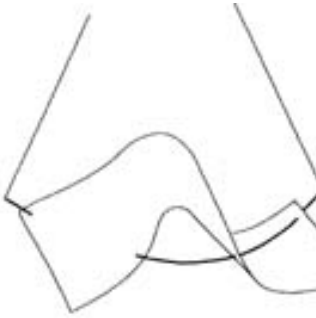
<b>Design Number</b>	221542		
<b>Class</b>	21-01		
<b>1)Anindita Toy Company Private Limited</b> SC 1/12, Kohinoor Estate, Behind Kamal Nayan Bajaj Udyan, Mumbai-Pune Road, Pune-411003, Maharashtra, India			
<b>Date of Registration</b>	06/03/2009		
<b>Title</b>	Toy Set		
<b>Priority NA</b>			
<b>Design Number</b>	221549		
<b>Class</b>	23-02		
<b>1)Shreeji Krupa Industries</b> Gondal Road, Near Lathiya Motor Garage, Rajkot, Gujarat, India, Pin Code No. 360004			
<b>Date of Registration</b>	06/03/2009		
<b>Title</b>	BATHROOM HOLDER		
<b>Priority NA</b>			
<b>Design Number</b>	221553		
<b>Class</b>	26-05		
<b>1)Koninklijke Philips Electronics N.V.,</b> Groenewoudseweg 1, 5621 Ba Eindhoven, The Netherlands.,			
<b>Date of Registration</b>	06/03/2009		
<b>Title</b>	Luminaire		
<b>Priority</b>			
Priority Number	Date	Country	
001000293	10/09/2008	OHIM	

<b>Design Number</b>	221565	
<b>Class</b>	13-01	
<b>1)Abb Ab.,</b> Ingenjor Baaths Gata 11, 721 83 Vasteras, Sweden.		
<b>Date of Registration</b>	06/03/2009	
<b>Title</b>	Motor	
<b>Priority</b>		
Priority Number	Date	Country
001005144-001	18/09/2008	EUROPEAN UNION

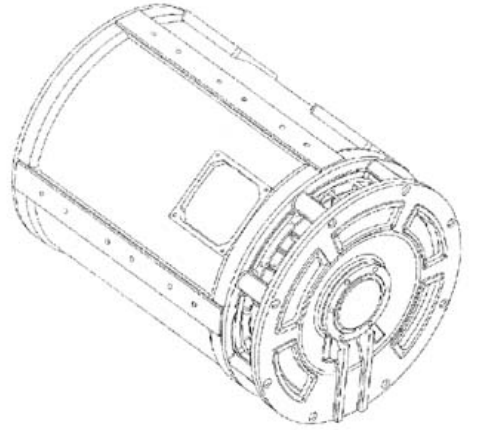

<b>Design Number</b>	221707	
<b>Class</b>	03-01	
<b>1)Orbit Creation</b> Shop No. 3, Indira Vihar, Himanshu Rai Road, Opp. Bombay Talkies Gate, Malad (West), Mumbai-400 064, Maharashtra, India.		
<b>Date of Registration</b>	17/03/2009	
<b>Title</b>	Jewel Case	
<b>Priority NA</b>		



<b>Design Number</b>	221715	
<b>Class</b>	13-01	
<b>1)Crompton Greaves Limited.,</b> 6th Floor, Cg House, Dr Annie Besant Road, Worli, Mumbai-400 030, Maharashtra, India.		
<b>Date of Registration</b>	17/03/2009	
<b>Title</b>	Motor	
<b>Priority NA</b>		





<b>Design Number</b>	221716	
<b>Class</b>	13-01	
<b>1)Crompton Greaves Limited.,</b> 6th Floor, Cg House, Dr Annie Besant Road, Worli, Mumbai-400 030, Maharashtra, India.		
<b>Date of Registration</b>	17/03/2009	
<b>Title</b>	Alternator	
<b>Priority NA</b>		
<b>Design Number</b>	221234	
<b>Class</b>	05-05	
<b>1)Charming Apparels (P) Ltd.,</b> 402-405, 1st Floor, Main Road, Chandni Chowk, Delhi-110 006, India.		
<b>Date of Registration</b>	16/02/2009	
<b>Title</b>	Textile Fabric	
<b>Priority NA</b>		
<b>Design Number</b>	213777	
<b>Class</b>	15-03	
<b>1)Standard Agriculture Works.,</b> Standard Chowk, Bathinda Road, Barnala-148 101, Punjab, India.		
<b>Date of Registration</b>	17/12/2007	
<b>Title</b>	Harvester	
<b>Priority NA</b>		

<b>Design Number</b>	221753		
<b>Class</b>	26-05		
<b>1)Crompton Greaves Limited.,</b> 6th Floor, Cg House, Dr Annie Besant Road, Worli, Mumbai-400 030, Maharashtra, India.			
<b>Date of Registration</b>	18/03/2009		
<b>Title</b>	Lighting Fixture		
<b>Priority NA</b>			
<b>Design Number</b>	221772		
<b>Class</b>	06-11		
<b>1)William Goodacre &amp; Sons India Pvt. Ltd.,</b> XVIII/1146 Revi Karunakarm Road, Alleppey, Kerala-688012, India			
<b>Date of Registration</b>	19/03/2009		
<b>Title</b>	Mat		
<b>Priority NA</b>			
<b>Design Number</b>	221802		
<b>Class</b>	23-04		
<b>1)Reckitt Benckiser (Uk) Limited.,</b> 103-105 Bath Road, Slough, Berkshire, SL1 3uh, Uk.			
<b>Date of Registration</b>	20/03/2009		
<b>Title</b>	Air Freshner Device		
<b>Priority</b>			
<b>Priority Number</b>	<b>Date</b>	<b>Country</b>	
001011381-0001	30/09/2008	EUROPEAN UNION	

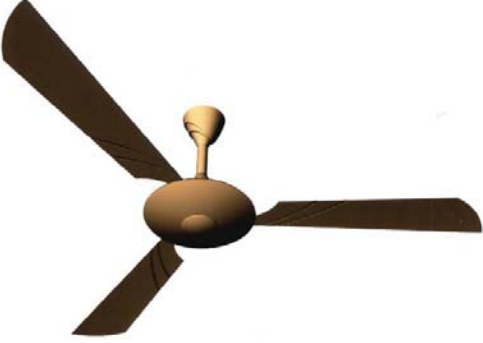





<b>Design Number</b>	221805	
<b>Class</b>	23-04	
<b>1)Crompton Greaves Limited.,</b> 6th Floor, Cg House, Dr Annie Besant Road, Worli, Mumbai-400 030, Maharashtra, India.		
<b>Date of Registration</b>	20/03/2009	
<b>Title</b>	Ceiling Fan	
<b>Priority NA</b>		

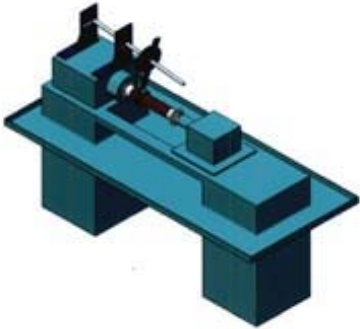

<b>Design Number</b>	221809	
<b>Class</b>	23-04	
<b>1)Crompton Greaves Limited.,</b> 6th Floor, Cg House, Dr Annie Besant Road, Worli, Mumbai-400 030, Maharashtra, India.		
<b>Date of Registration</b>	20/03/2009	
<b>Title</b>	Ceiling Fan	
<b>Priority NA</b>		

<b>Design Number</b>	221851	
<b>Class</b>	23-04	
<b>1)Crompton Greaves Limited.,</b> 6th Floor, Cg House, Dr Annie Besant Road, Worli, Mumbai-400 030, Maharashtra, India.		
<b>Date of Registration</b>	23/03/2009	
<b>Title</b>	Ceiling Fan	
<b>Priority NA</b>		

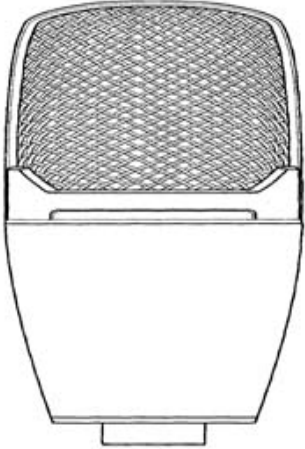

<b>Design Number</b>	221883	
<b>Class</b>	21-02	
<b>1)Taneja Kaushal Omprakash.,</b> Ground Floor,74/77,Shree Krishna Center, Nr. Lift, Opp.Amabaji Mataji Temple, Nr. Mithakhali Six Cross Road, Mithakhali, Navrangpura, Ahmed.-380009.		
<b>Date of Registration</b>	24/03/2009	
<b>Title</b>	Massager Device	
<b>Priority NA</b>		
<b>Design Number</b>	221914	
<b>Class</b>	08-08	
<b>1)Crompton Greaves Limited.,</b> 6th Floor, Cg House, Dr Annie Besant Road, Worli, Mumbai-400 030, Maharashtra, India.		
<b>Date of Registration</b>	24/03/2009	
<b>Title</b>	Coil Winding Fixture	
<b>Priority NA</b>		
<b>Design Number</b>	221928	
<b>Class</b>	13-99	
<b>1)Crompton Greaves Limited.,</b> 6th Floor, Cg House, Dr Annie Besant Road, Worli, Mumbai-400 030, Maharashtra, India.		
<b>Date of Registration</b>	25/03/2009	
<b>Title</b>	Device for Disassembling the stator and rotor of a motor	
<b>Priority NA</b>		

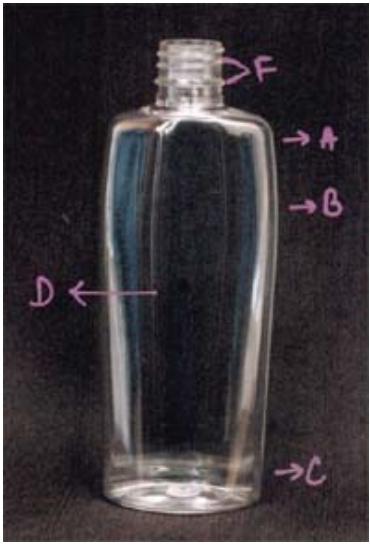
<b>Design Number</b>	221933	
<b>Class</b>	10-04	
<b>1)Crompton Greaves Limited.,</b> 6th Floor, Cg House, Dr Annie Besant Road, Worli, Mumbai-400 030, Maharashtra, India.		
<b>Date of Registration</b>	25/03/2009	
<b>Title</b>	Oil Level Indicator	
<b>Priority NA</b>		
<b>Design Number</b>	221980	
<b>Class</b>	06-02	
<b>1)Godrej &amp; Boyce Mfg. Co. Ltd.,</b> Pirojshanagar, Vikhroli, Mumbai-400 079, Maharashtra, India.		
<b>Date of Registration</b>	26/03/2009	
<b>Title</b>	Fowler Bed	
<b>Priority NA</b>		
<b>Design Number</b>	221992	
<b>Class</b>	14-03	
<b>1)Shure Acquisitions Holdings Inc.,</b> 5800 West Touhy Avenue, Niles, Illinois 60714, Usa.		
<b>Date of Registration</b>	27/03/2009	
<b>Title</b>	Microphone	
<b>Priority NA</b>		

<b>Design Number</b>	219827	
<b>Class</b>	09-01	
<b>1)Varahi Private Limited</b> WZ-8/1, Industrial Area, Kirti Nagar, New Delhi-110015, India		
<b>Date of Registration</b>	21/11/2008	
<b>Title</b>	Bottle	
<b>Priority NA</b>		
<b>Design Number</b>	219828	
<b>Class</b>	09-01	
<b>1)Varahi Private Limited</b> WZ-8/1, Industrial Area, Kirti Nagar, New Delhi-110015, India		
<b>Date of Registration</b>	21/11/2008	
<b>Title</b>	Bottle	
<b>Priority NA</b>		
<b>Design Number</b>	219875	
<b>Class</b>	30-03	
<b>1)M/s. Ganpati Poultry Equipments</b> 14/27B, Dr. H.K. Chatterjee Lane, Ghusuri, Howrah-711107, West Bengal, India		
<b>Date of Registration</b>	26/11/2008	
<b>Title</b>	Tray	
<b>Priority NA</b>		

<b>Design Number</b>	219876	
<b>Class</b>	30-03	
<b>1)Ganpati Poultry Equipments</b> 14/27B, Dr. H.K. Chatterjee Lane, Ghosuri, Howrah-711107, West Bengal, India		
<b>Date of Registration</b>	26/11/2008	
<b>Title</b>	Drinking & Feeder Stand	
<b>Priority NA</b>		

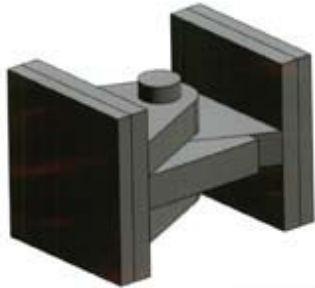
<b>Design Number</b>	222053	
<b>Class</b>	08-99	
<b>1)Crompton Greaves Limited.,</b> 6th Floor, Cg House, Dr Annie Besant Road, Worli, Mumbai-400 030, Maharashtra, India.		
<b>Date of Registration</b>	30/03/2009	
<b>Title</b>	Damper for Switchgear Assembly	
<b>Priority NA</b>		

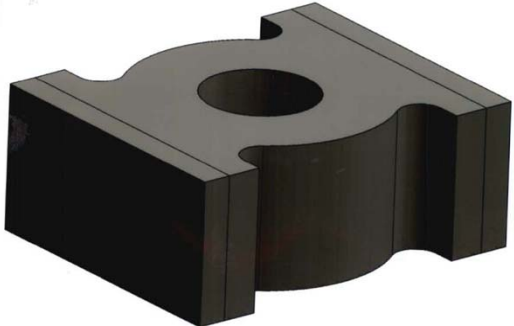
<b>Design Number</b>	222062	
<b>Class</b>	08-99	
<b>1)Crompton Greaves Limited.,</b> 6th Floor, Cg House, Dr Annie Besant Road, Worli, Mumbai-400 030, Maharashtra, India.		
<b>Date of Registration</b>	30/03/2009	
<b>Title</b>	Damper for Switchgear Assembly	
<b>Priority NA</b>		

<b>Design Number</b>	222065	
<b>Class</b>	08-99	
<b>1)Crompton Greaves Limited.,</b> 6th Floor, Cg House, Dr Annie Besant Road, Worli, Mumbai-400 030, Maharashtra, India.		
<b>Date of Registration</b>	30/03/2009	
<b>Title</b>	Damper for Switchgear Assembly	
<b>Priority NA</b>		

<b>Design Number</b>	222087		
<b>Class</b>	08-05		
<b>1)3m Innovative Properties Company.,</b> 3m Center, Saint Paul, Minnesota 55133-3427, Usa.			
<b>Date of Registration</b>	30/03/2009		
<b>Title</b>	Dual Chamber Mixing Gun		
<b>Priority</b>			
Priority Number	Date	Country	
29/325,463	01/10/2008	U.S.A.	

<b>Design Number</b>	222094		
<b>Class</b>	23-04		
<b>1)Crompton Greaves Limited.,</b> 6th Floor, Cg House, Dr Annie Besant Road, Worli, Mumbai-400 030, Maharashtra, India.			
<b>Date of Registration</b>	30/03/2009		
<b>Title</b>	Ceiling Fan		
<b>Priority NA</b>			

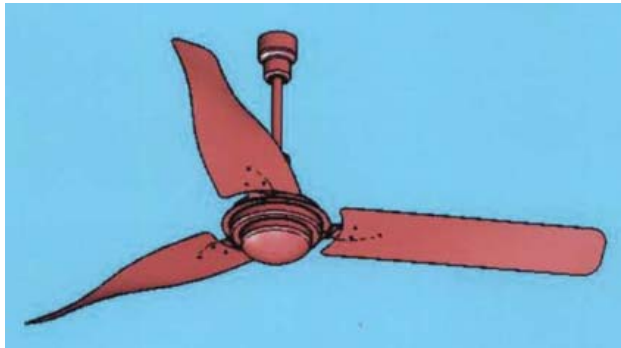
<b>Design Number</b>	222099	
<b>Class</b>	23-04	
<b>1)Crompton Greaves Limited.,</b> 6th Floor, Cg House, Dr Annie Besant Road, Worli, Mumbai-400 030, Maharashtra, India.		
<b>Date of Registration</b>	30/03/2009	
<b>Title</b>	Ceiling Fan	
<b>Priority NA</b>		

<b>Design Number</b>	222113	
<b>Class</b>	09-01	
<b>1)Elder Health Care Limited.,</b> Elder House, Plot No. C-9, Dalia Industrial Estate, Off. Veera Desai Road, Andheri (West), Mumbai-400 053, Maharashtra, India.		
<b>Date of Registration</b>	30/03/2009	
<b>Title</b>	Bottle	
<b>Priority NA</b>		

<b>Design Number</b>	222128	
<b>Class</b>	13-99	
<b>1)Crompton Greaves Limited.,</b> 6th Floor, Cg House, Dr Annie Besant Road, Worli, Mumbai-400 030, Maharashtra, India.		
<b>Date of Registration</b>	31/03/2009	
<b>Title</b>	Electric Holder	
<b>Priority NA</b>		

<b>Design Number</b>	222217
<b>Class</b>	26-03
<b>1)Crompton Greaves Limited.,</b> 6th Floor, Cg House, Dr Annie Besant Road, Worli, Mumbai-400 030, Maharashtra, India.	
<b>Date of Registration</b>	31/03/2009
<b>Title</b>	Lighting Fixture
<b>Priority NA</b>	

