



CONTINUED FROM PART- 2

INTRODUCTION

In view of the recent amendment made in the Designs (Amendment) Rules, 2008 with effect from 17/06/2008, Publication of the matter relating to Designs is being published in the Official Journal of The Patent Office. This Journal is being published on weekly basis on every Friday covering the various proceedings on Designs as required according to the provisions of under Rule 22, 25, 27 and 39 of the Design (Amendment) Rules, 2008. All the enquiries on this Official Journal and other information as required by the public should be addressed to the Controller General of Patents, Designs & Trade Marks. Suggestions and comments are requested from all quarters so that the content can be enriched.

REGISTRATION OF DESIGNS

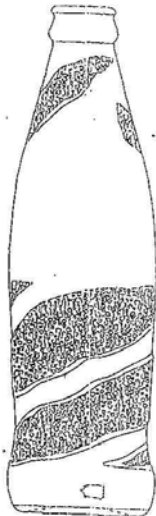

The following designs have been registered. They are now open for public inspection. In the following each entry the Date of Registration is shown. The Priority Number, Priority Date and Priority Country are also shown

Design Number	178185	
Class	09-01	
1)Pepsico Inc 700 Anderson Hill Road, Purchase, New York 10577, SA		
Date of Registration	28/12/1998	
Title	Beverage Bottle	
Priority NA		
Design Number	216926	
Class	05-05	
1)Biba Apparels Pvt. Ltd., 45-54, "Whitehall", Kemps Corner, 143, A.K.Marg, Mumbai-400 036. Maharashtra, India.		
Date of Registration	30/06/2008	
Title	Textile Fabric	
Priority NA		
Design Number	220241	
Class	11-01	
1)Jewelex India Pvt. Ltd., Plot 56 B, Seepz, Andheri East, Mumbai-400 096, India		
Date of Registration	16/12/2008	
Title	Gem Stoane	
Priority NA		

Design Number	220445	
Class	26-05	
1)Indian Oil Corporation Limited Research & Development Centre, Sector-13, Faridabad-121007, Haryana, India		
Date of Registration	24/12/2008	
Title	Wick Lamp	
Priority NA		

Design Number	198033	
Class	07-02	
1)Dart Industries Inc Delaware,U.S.A.Of 14901,South Orange Blossom Trail Orlando Florida 32837 U.S.A		
Date of Registration	29/12/2004	
Title	Container	
Priority		
Priority Number	Date	Country
29/209,844	22/07/2004	U.S.A.

Design Number	219723	
Class	24-01	
1)Alembic Limited Alembic Road, Alembic Campus, Vadodara-390003, Gujarat, India		
Date of Registration	17/11/2008	
Title	Precipitator	
Priority NA		

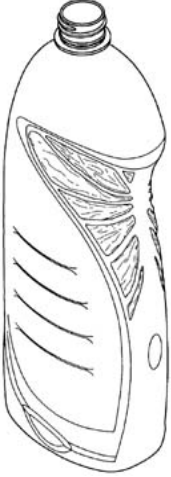
Design Number	219744	
Class	06-04	
1)Ultra Fab India Pvt. Ltd., Survey No.263/3/4, Plot No.12, Sayali Silvassa, Dadra Nagar Haveli. Gujarat-India		
Date of Registration	18/11/2008	
Title	Furniture	
Priority NA		
Design Number	219777	
Class	23-01	
1)M/S. Shakti Industries 40, Nageshwar Estate, Opp. Javahar Nagar, Amreiwadi, Ahmedabad- 380026, Gujarat, India		
Date of Registration	20/11/2008	
Title	window Flange	
Priority NA		
Design Number	220134	
Class	09-01	
1)Hindustan Unilever Limited., Hindustan Lever House 165/166, Backbay Reclamation, Mumbai-400 020, Maharashtra, India.		
Date of Registration	10/12/2008	
Title	Bottle	
Priority NA		

Design Number	218959	
Class	14-03	
1)M/s. King Multitech Global Pvt. Limited G.T. Road, Near Octroi Post, Sahnewal, Ludhiana-141120 (Punjab) (India)		
Date of Registration	03/10/2008	
Title	Cell Chip	
Priority NA		
Design Number	220911	
Class	23-01	
1)Klaus Waren Fixtures Pvt. Ltd., 285, Paek View, 1st Floor, Flat No. 9, B.A.K Anjan Marg, Opp. Napoo Garden, Matunga (Central Railway) (E), Mambai-400 019, Maharashtra, India.		
Date of Registration	23/01/2009	
Title	Basin Mixer	
Priority NA		
Design Number	220912	
Class	23-01	
1)Klaus Waren Fixtures Pvt. Ltd., 285, Paek View, 1st Floor, Flat No. 9, B.A.K Anjan Marg, Opp. Napoo Garden, Matunga (Central Railway) (E), Mumbai-400 019, Maharashtra, India.		
Date of Registration	23/01/2009	
Title	Basin Mixer	
Priority NA		

Design Number	220929	
Class	13-03	
1)Diamond Enterprises RZ-283/57, West Block, Vishnu Garden, New Delhi-110018		
Date of Registration	27/01/2009	
Title	Multiplug	
Priority NA		
Design Number	221074	
Class	12-16	
1)Doga S.A., Carretera N-II, Km. 583, Abrera-08630, Barcelona, Spain.		
Date of Registration	04/02/2009	
Title	Windscreen Wipers	
Priority		
Priority Number	Date	Country
000982871-0002	05/08/2008	EUROPEAN UNION
Design Number		
221075		
Class		
12-16		
1)Doga S.A., Carretera N-II, Km. 583, Abrera-08630, Barcelona, Spain.		
Date of Registration		
04/02/2009		
Title		
Windscreen Wipers		
Priority		
Priority Number	Date	Country
000982871-0003	05/08/2008	EUROPEAN UNION

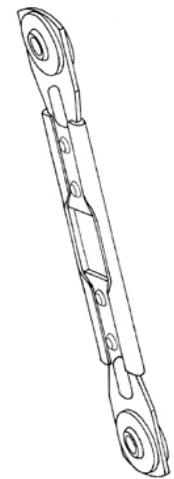
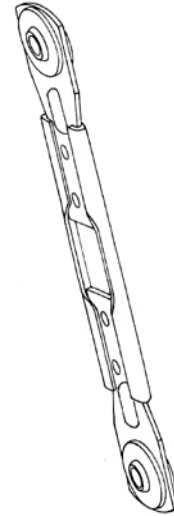

Design Number	221115	
Class	13-03	
1)Crompton Greaves Limited, 6th Floor, CG House, Dr Annie Besant Road, Worli, Mumbai 400030, Maharashtra, India		
Date of Registration	09/02/2009	
Title	Fan Regulator	
Priority NA		
Design Number	221117	
Class	23-03	
1)Crompton Greaves Limited., 6th Floor, Cg House, Dr Annie Besant Road, Worli, Mumbai-400 030, Maharashtra, India.		
Date of Registration	09/02/2009	
Title	"Geyser"	
Priority NA		
Design Number	221126	
Class	12-15	
1)Ceat Limited., Ceat Mahal, 463, Anne Besant Road, Worli, Mumbai-400 030, India.		
Date of Registration	10/02/2009	
Title	Motorcycle Tyre	
Priority NA		

Design Number	210915
Class	08-05
1)AIR BRIDGE SCAFFOLDING PVT. LTD. ICHAPUR KAMARDANGA, HOWRAH-711104	
Date of Registration	20/06/2007
Title	Span Beam
Priority NA	



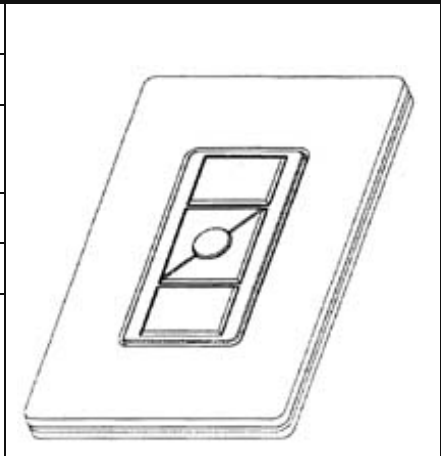

Design Number	218975	
Class	14-03	
1)Lutron Electronics Company, Inc., 7200 Suter Road Coopersburg, Pennsylvania 18036-1299, USA		
Date of Registration	03/10/2008	
Title	Wall Remote Control Device	
Priority		
Priority Number	Date	Country
29/306,225	04/04/2008	U.S.A.





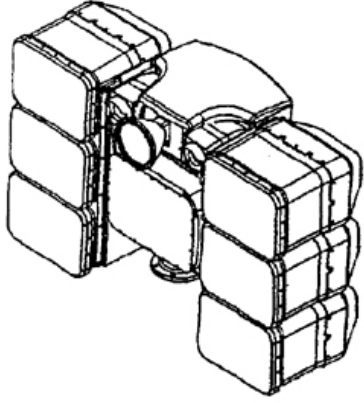

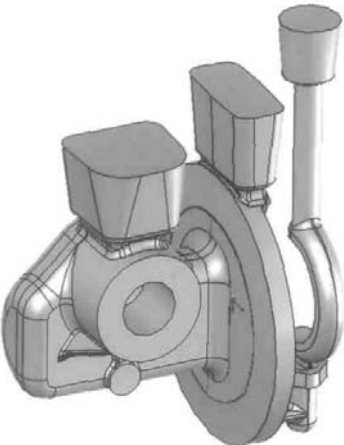
Design Number	219007	
Class	02-02	
1)Charming Apparels (P) Ltd., 402-405, 1st Floor, Main Road, Chandni Chowk, Delhi-110 006, India.		
Date of Registration	06/10/2008	
Title	Dress Material	
Priority NA		

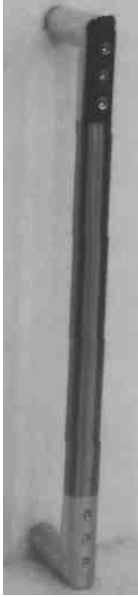

Design Number	219249		
Class	10-05		
1)Moog Inc., Jamison Road, East Aurora, New York 14052			
Date of Registration	16/10/2008		
Title	Six Speaker Remote Acoustic		
Priority			
Priority Number	Date	Country	
29/307, 440	21/04/2008	U.S.A.	
Design Number	219335		
Class	21-02		
1)Sharma Exports B-16, Sports & Surgical Complex, Kapurthala Road, Jalandhar-144021 (Punjab) India			
Date of Registration	20/10/2008		
Title	BALL (TOY)		
Priority NA			
Design Number	209206		
Class	08-05		
1)CROMPTOM GREAVES LIMITED 6TH FLOOR.CG HOUSE, DR ANNIE BESANT ROAD, WORLI, MUMBAI â€“400030, MAHARASHTRA, INDIA			
Date of Registration	30/03/2007		
Title	METAL CASTING FOR CIRCUIT BREAKER		
Priority NA			

Design Number	215723	
Class	26-03	
1)Crompton Greaves Limited, 6th Floor, CG House, Dr Annie Besant Road, Worli, Mumbai 400030, Maharashtra, India		
Date of Registration	31/03/2008	
Title	Street Lighting Fixture	
Priority NA		
Design Number	218105	
Class	09-01	
1)Zenna Plastics Limited Plot No-19-A,Mira Co-Op.Industrial Estate Western Express Highway Mira-401104 Thane,Maharashtra,India		
Date of Registration	25/08/2008	
Title	Bottle	
Priority NA		
Design Number	218134	
Class	08-06	
1)Shree Technocast Aji G.I.D.C.Shed No.K-1-242/5,Maltech Chowk,Rajkot,Gujarat(India)		
Date of Registration	27/08/2008	
Title	Handle	
Priority NA		

Design Number	218135	
Class	08-06	
1)Shree Technocast Aji G.I.D.C.Shed No.K-1-242/5,Maltech Chowk,Rajkot,Gujarat(India)		
Date of Registration	27/08/2008	
Title	Handle	
Priority NA		
Design Number	218137	
Class	13-03	
1)Shree Technocast Aji G.I.D.C.Shed No.K-1-242/5 Maltech Chowk Rajkot,Gujarat (India)		
Date of Registration	27/08/2008	
Title	Cable Holder	
Priority NA		
Design Number	218138	
Class	08-06	
1)Shree Technocast Aji G.I.D.C.Shed No.K-1-242/5,Maltech Chowk,Rajkot,Gujarat (India)		
Date of Registration	27/08/2008	
Title	Handle	
Priority NA		

Design Number	218139	
Class	08-06	
1)Shree Technocast Aji G.I.D.C.Shed No.K-1-242/5,Maltech Chowk, Rajkot,Gujarat (India)		
Date of Registration	27/08/2008	
Title	Handle	
Priority NA		
Design Number	218140	
Class	08-06	
1)Shree Technocast Aji G.I.D.C.Shed No.K-1-242/5,Maltech Chowk,Rajkot,Gujarat,(India)		
Date of Registration	27/08/2008	
Title	Handle	
Priority NA		
Design Number	218141	
Class	08-06	
1)Shree Technocast AJI G.I.D.C., Shed No.K-1-242/5, Maltech chowk, Rajkot, Gujarat, India		
Date of Registration	27/08/2008	
Title	Handle	
Priority NA		
Design Number	218142	
Class	08-06	
1)Shree Technocast		

AJI G.I.D.C., Shed No.K-1-242/5, Maltech chowk, Rajkot, Gujarat, India		
Date of Registration	27/08/2008	
Title	Handle	
Priority NA		
Design Number	218143	
Class	08-06	
1)Shree Technocast AJI G.I.D.C., Shed No.K-1-242/5, Maltech chowk, Rajkot, Gujarat, India		
Date of Registration	27/08/2008	
Title	Handle	
Priority NA		
Design Number	218144	
Class	08-06	
1)Shree Technocast Aji G.I.D.C., Shed No. K-1-242/5, Maltech Chowk, Rajkot, Gujarat, India		
Date of Registration	27/08/2008	
Title	Handle	
Priority NA		

Design Number	218145	
Class	08-06	
1)Shree Technocast Aji G.I.D.C., Shed No. K-1-242/5, Maltech Chowk, Rajkot, Gujarat, India		
Date of Registration	27/08/2008	
Title	Handle	
Priority NA		
Design Number	218146	
Class	08-06	
1)Shree Technocast AJI G.I.D.C., Shed No.K-1-242/5, Maltech chowk, Rajkot, Gujarat, India		
Date of Registration	27/08/2008	
Title	Handle	
Priority NA		
Design Number	218239	
Class	07-02	
1)Ravissant Pvt.Ltd., 50-51,Commerical Complex,New Friends Colony,New Delhi-110065 India		
Date of Registration	29/08/2008	
Title	Milk Pot	
Priority NA		

Design Number	199007	
Class	08-05	
1)World Wide Welding Inc 3705 Centre Circle, Fort Mill, South Carolina 29715-9753, USA		
Date of Registration	24/03/2005	
Title	Grease Gun Head	
Priority		
Priority Number	Date	Country
29/214,310	30/09/2004	U.S.A.



Design Number	199008	
Class	08-05	
1)World Wide Welding Inc., 3705 Centre Circle, Fort Mill, South Carolina 29715-9753, USA		
Date of Registration	24/03/2005	
Title	Grease Gun Head	
Priority		
Priority Number	Date	Country
29/214,314	30/09/2004	U.S.A.

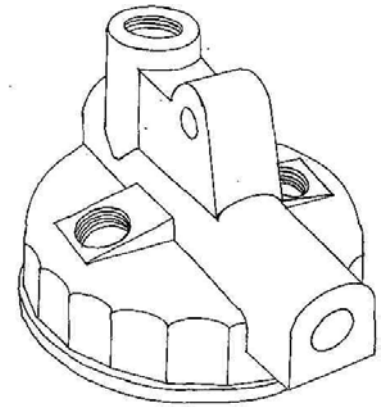

Design Number	199013	
Class	23-01	
1)World Wide Welding Inc. 3705 Centre Circle, Fort Mill, South Carolina 29715-9753, U.S.A.		
Date of Registration	24/03/2005	
Title	Pump Head	
Priority		
Priority Number	Date	Country
29/214,309	30/09/2004	U.S.A.

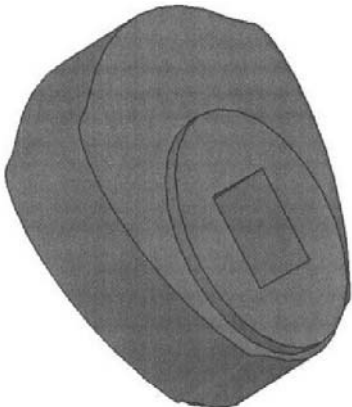

Design Number	210112	
Class	07-07	
1)WELMADE LOCKING SYSTEMS PVT. LTD J-61, M.I.D.C., BHOSARI, PUNE-411026, MAHARASHTRA, INDIA.		
Date of Registration	10/05/2007	
Title	DRAWER LOCK	
Priority NA		

Design Number	210156	
Class	15-99	
1)Q-CORE LTD., P.O.B. 3341, PETACH TIKVA 49130, ISRAEL.		
Date of Registration	13/11/2006	
Title	CAMSHAFT FOR INFUSION PERISTALTIC PUMP WITH TWO CRESCENT FORMS	
Priority		
Priority Number	Date	Country
43319	13/11/2006	Israel

Design Number	215169	
Class	04-02	
1)Hindustan Unilever Limited., Hindustan Lever House 165/166, Backbay Reclamation, Mumbai-400 020, Maharashtra, India.		
Date of Registration	07/03/2008	
Title	Toothbrush	
Priority NA		

Design Number	219435	
Class	15-05	
1)Koninklijke Philips Electronics N. V. Groenewoudseweg 1, 5621 BA Eindhoven, The Netherlands		
Date of Registration	24/10/2008	
Title	Vacuum Cleaner With Head	
Priority		
Priority Number	Date	Country
000924816-0001	25/04/2008	OHIM

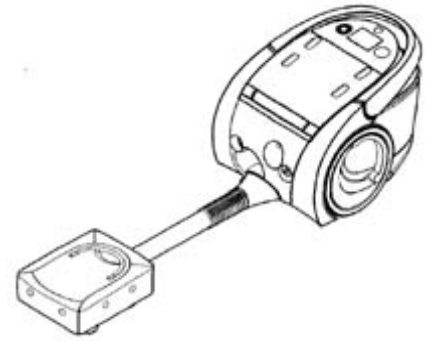

Design Number	221464	
Class	05-05	
1)Charming Apparels (P) Ltd., 402-405, 1st Floor, Main Road, Chandni Chowk, Delhi-110006, India		
Date of Registration	27/02/2009	
Title	Textile Fabric	
Priority NA		

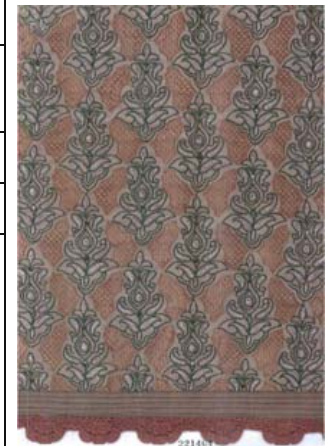



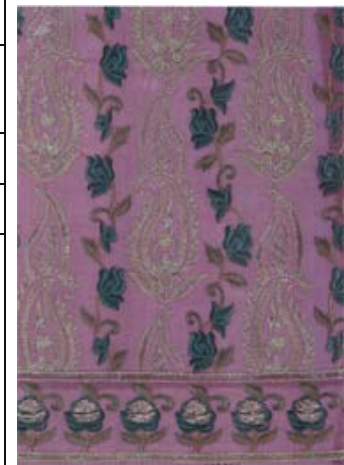



Design Number	221468	
Class	05-05	
1)Charming Apparels (P) Ltd., 402-405, 1st Floor, Main Road, Chandni Chowk, Delhi-110 006, India.		
Date of Registration	27/02/2009	
Title	Textile Fabric	
Priority NA		



Design Number	218398	
Class	06-13	
1)Rosebys Interiors India Limited A-17, Sector 58, Noida-201303, Uttar Pradesh, India.		
Date of Registration	05/09/2008	
Title	Pillow Case	
Priority NA		
Design Number	218400	
Class	06-13	
1)Rosebys Interiors India Limited A-17, Sector 58, Noida-201303, Uttar Pradesh		
Date of Registration	05/09/2008	
Title	Pillow case	
Priority NA		
Design Number	218401	
Class	06-13	
1)Rosebys Interiors India Limited A-17, Sector 58, Noida-201303, Uttar Pradesh		
Date of Registration	05/09/2008	
Title	Pillow Case	
Priority NA		

Design Number	220666	
Class	14-02	
1)Su-Kam Power Systems Ltd., Plot No. Wz-1401/2, Nangal Raya, New Delhi-110 046, India.		
Date of Registration	05/01/2009	
Title	Battery	
Priority NA		
Design Number	220668	
Class	14-02	
1)Innoviti Embedded Solutions Pvt. Ltd., Ngr The Edge, No. 41, 2nd & 3rd Floor, 3rd Main, 5th Cross, Saibaba Mandir Road, Cambridge Layout, Halasuru, Bangalore-560 008, Karnataka, India.		
Date of Registration	05/01/2009	
Title	Biometric Device	
Priority NA		
Design Number	220725	
Class	23-04	
1)Surindra Polymers B-6, Dside Complex, Rohtak Road, Nangloi, Delhi-110 041, India		
Date of Registration	09/01/2009	
Title	Cooler Body	
Priority NA		

Design Number	220790	
Class	09-03	
1)Balmer Lawrie & Company Ltd., 21, Netaji Subhas Road, Kolkata-700 001, WB, India.		
Date of Registration	15/01/2009	
Title	Barrel	
Priority NA		
Design Number	220791	
Class	09-03	
1)Balmer Lawrie & Company Ltd., 21, Netaji Subhas Road, Kolkata-700 001, WB, India.		
Date of Registration	15/01/2009	
Title	Barrel	
Priority NA		
Design Number	220792	
Class	09-03	
1)Balmer Lawrie & Company Ltd., 21, Netaji Subhas Road, Kolkata-700 001, WB, India.		
Date of Registration	15/01/2009	
Title	Barrel	
Priority NA		

Design Number	220793	
Class	09-03	
1)Balmer Lawrie & Company Ltd., 21, Netaji Subhas Road, Kolkata-700 001, WB, India.		
Date of Registration	15/01/2009	
Title	Barrel	
Priority NA		
Design Number	220830	
Class	12-11	
1)Voltan Industries., D-9, Textile Colony, Industrial Area-A, Ludhiana-141 003, Punjab, India.		
Date of Registration	19/01/2009	
Title	Triple Chain Wheel With Guard & Crank For Bicycle	
Priority NA		
Design Number	220859	
Class	05-05	
1)Charming Apparels (P) Ltd., 402-405, 1st Floor, Main Road, Chandni Chowk, Delhi-110006, India		
Date of Registration	20/01/2009	
Title	Textile Fabric	
Priority NA		