



## ***CONTINUED FROM PART - 2***



### **INTRODUCTION**

In view of the recent amendment made in the Designs (Amendment) Rules, 2008 with effect from 17/06/2008, Publication of the matter relating to Designs is being published in the Official Journal of The Patent Office. This Journal is being published on weekly basis on every Friday covering the various proceedings on Designs as required according to the provisions of under Rule 22, 25, 27 and 39 of the Design (Amendment) Rules, 2008. All the enquiries on this Official Journal and other information as required by the public should be addressed to the Controller General of Patents, Designs & Trade Marks. Suggestions and comments are requested from all quarters so that the content can be enriched.

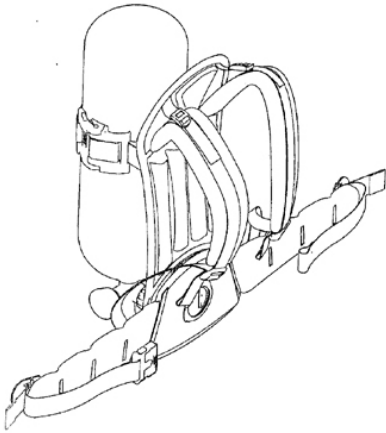
## REGISTRATION OF DESIGNS

The following designs have been registered. They are now open for public inspection. In the following each entry the Date of Registration is shown. The Priority Number, Priority Date and Priority Country are also shown

<b>Design Number</b>	218700		
<b>Class</b>	10-06		
<b>1)Carl F India Private Limited</b> Oberoi Garden Estate, "A" Wing, 3rd floor, Chandivali Farms Road, Andheri-East, Mumbai-400072, Maharashtra, India			
<b>Date of Registration</b>	23/09/2008		
<b>Title</b>	"SIGNAL (FOR INDICATING LOCATION)"		
<b>Priority NA</b>			
<b>Design Number</b>	219040		
<b>Class</b>	29-02		
<b>1)Scott Health &amp; Safety Ltd.,</b> Pimbo Road, West Pimbo, Skelmersdale WN8 9RA, Lancashire, United Kingdom			
<b>Date of Registration</b>	10/10/2008		
<b>Title</b>	Harness For Carrying Breathing Apparatus		
<b>Priority</b>			
<b>Priority Number</b>	<b>Date</b>	<b>Country</b>	
000915491	09/04/2009	OHIM	
<b>Design Number</b>	221784		
<b>Class</b>	23-01		
<b>1)Hansgrohe AG.,</b> Auestr. 5-9, D-77761 Schiltach, Germany.			
<b>Date of Registration</b>	19/03/2009		
<b>Title</b>	Sanitary Faucet		
<b>Priority</b>			
<b>Priority Number</b>	<b>Date</b>	<b>Country</b>	
001011415-0001	26/09/2008	OHIM	

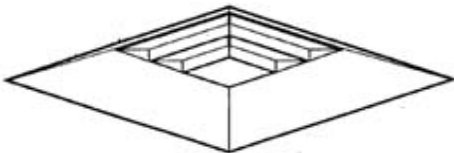
<b>Design Number</b>	221785		
<b>Class</b>	23-01		
<b>1)Hansgrohe AG</b> Auestr. 5-9, D-77761 Schiltach, Germany			
<b>Date of Registration</b>	19/03/2009		
<b>Title</b>	Sanitary Fitting		
<b>Priority</b>			
Priority Number	Date	Country	
001011415-0009	26/09/2008	OHIM	
<b>Design Number</b>	221911		
<b>Class</b>	26-03		
<b>1)Crompton Greaves Limited.,</b> 6th Floor, C.G. House, Dr Annie Besant Road, Worli, Mumbai-400 030, Maharashtra, India.			
<b>Date of Registration</b>	24/03/2009		
<b>Title</b>	Lighting Fixture		
<b>Priority NA</b>			
<b>Design Number</b>	213075		
<b>Class</b>	26-05		
<b>1)Led Lighting Fixtures, Inc.,</b> 617 Davis Drive, Suite 200, Keystone Technology, Park VI, Morrisville, Nc 27560, USA			
<b>Date of Registration</b>	26/10/2007		
<b>Title</b>	Lighting device		
<b>Priority</b>			
Priority Number	Date	Country	
29/279,583	03/05/2007	U.S.A.	

<b>Design Number</b>	216063	
<b>Class</b>	24-02	
<b>1)Drug Enhancement Company Of America, Llc.,</b> P.O.Box 276, Union, Kentucky 41091, USA.		
<b>Date of Registration</b>	28/04/2008	
<b>Title</b>	Medicament Dispenser	
<b>Priority</b>		
Priority Number	Date	Country
29/296,922	31/10/2007	U.S.A.

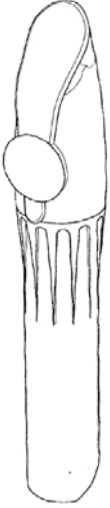



<b>Design Number</b>	218387	
<b>Class</b>	11-02	
<b>1)Girijaa Upadhyay</b> Centre Terrace Flat, 6th Floor, Kasturi Building, 18-20 J. Tata Road, Churchgate, Mumbai-400020, Maharashtra, India		
<b>Date of Registration</b>	05/09/2008	
<b>Title</b>	Book Ends	
<b>Priority NA</b>		



<b>Design Number</b>	218399	
<b>Class</b>	06-13	
<b>1)Rosebys Interiors India Limited</b> A-17, Sector 58, Noida-201303, Uttar Pradesh		
<b>Date of Registration</b>	05/09/2008	
<b>Title</b>	Pillow case	
<b>Priority NA</b>		



<b>Design Number</b>	218637	
<b>Class</b>	10-05	
<b>1)Texla Plastics &amp; Metals Pvt. Ltd.,</b> 3 Masjid Road, Jangpura, New Delhi-110014, India		
<b>Date of Registration</b>	18/09/2008	
<b>Title</b>	Safety Light Bar	
<b>Priority NA</b>		
<b>Design Number</b>	222203	
<b>Class</b>	13-99	
<b>1)Crompton Greaves Limited.,</b> 6th Floor, C.G. House, Dr Annie Besant Road, Worli, Mumbai-400 030, Maharashtra, India.		
<b>Date of Registration</b>	31/03/2009	
<b>Title</b>	Magnetic Field Contact	
<b>Priority NA</b>		
<b>Design Number</b>	222206	
<b>Class</b>	13-99	
<b>1)Crompton Greaves Limited.,</b> 6th Floor, C.G. House, Dr Annie Besant Road, Worli, Mumbai-400 030, Maharashtra, India.		
<b>Date of Registration</b>	31/03/2009	
<b>Title</b>	Winding Former	
<b>Priority NA</b>		

<b>Design Number</b>	207390	
<b>Class</b>	24-04	
<b>1)3M Innovative Properties Company</b> 3M Center, Saint Paul, Minnesota 55133-3427, USA		
<b>Date of Registration</b>	12/12/2006	
<b>Title</b>	Bandage	
<b>Priority</b>		
Priority Number	Date	Country
29/261,302	12/06/2006	U.S.A.

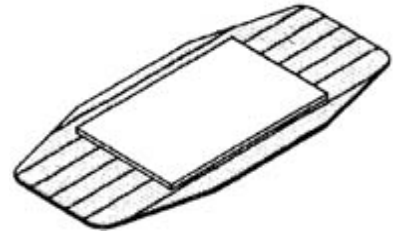





<b>Design Number</b>	219255	
<b>Class</b>	06-05	
<b>1)Veneta Cucine S.P.A.,</b> Via Paris Bordone, 84, 31056 Roncade, Frazione Biancade (Prov. of Treviso), Italy		
<b>Date of Registration</b>	16/10/2008	
<b>Title</b>	Kitchen Furniture	
<b>Priority</b>		
Priority Number	Date	Country
VE2008O000008	16/04/2008	Italy

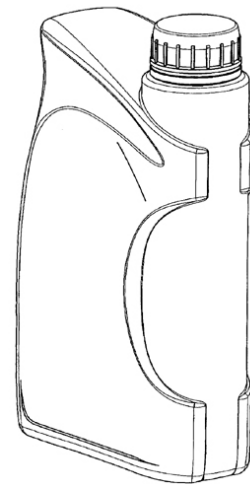



<b>Design Number</b>	219387	
<b>Class</b>	09-02	
<b>1)Total Sa</b> 2 Place Jean Millier La Defense 6 92400 Courbevoie France		
<b>Date of Registration</b>	21/10/2008	
<b>Title</b>	Container	
<b>Priority</b>		
Priority Number	Date	Country
082262	19/05/2008	France



<b>Design Number</b>	219502		
<b>Class</b>	21-01		
<b>1)3L-Rask Aps</b> Vibaekvej 100, Brylle, 5690 Tommerup, Denmark			
<b>Date of Registration</b>	31/10/2008		
<b>Title</b>	Building Bricks		
<b>Priority</b>			
Priority Number	Date	Country	
000927850-0005	02/05/2008	OHIM	
<b>Design Number</b>	220688		
<b>Class</b>	10-06		
<b>1)B. D.Industries.,</b> 5, Raj Rajeshwari Road, Opposite Naval Stores Main Gate, LBS Marg, Narayan Nagar, Ghatkopar, (W) Mumbai-400086, Maharashtra, India.			
<b>Date of Registration</b>	06/01/2009		
<b>Title</b>	Road Safety Device		
<b>Priority NA</b>			
<b>Design Number</b>	220722		
<b>Class</b>	26-04		
<b>1)Ijs, Electronics.,</b> W-25, Okhla Industrial Area, Phase-2, New Delhi-110 020, India.			
<b>Date of Registration</b>	09/01/2009		
<b>Title</b>	Led Disc		
<b>Priority NA</b>			

<b>Design Number</b>	216922	
<b>Class</b>	05-05	
<b>1)Biba Apparels Pvt. Ltd.,</b> 45-54, Whitehall , Kemps Cornet, 143, A.K.Marg, Mumbai-400 036. Maharashtra, India.		
<b>Date of Registration</b>	30/06/2008	
<b>Title</b>	Textile Fabric	
<b>Priority NA</b>		
<b>Design Number</b>	216923	
<b>Class</b>	05-05	
<b>1)Biba Apparels Pvt. Ltd.,</b> 45-54, Whitehall , Kemps Cornet, 143, A.K.Marg, Mumbai-400 036. Maharashtra, India.		
<b>Date of Registration</b>	30/06/2008	
<b>Title</b>	Trextile Fabric	
<b>Priority NA</b>		
<b>Design Number</b>	216924	
<b>Class</b>	05-05	
<b>1)Biba Apparels Pvt. Ltd.,</b> 45-54, Whitehall , Kemps Corner, 143, A.K.Marg, Mumbai-400 036. Maharashtra, India.		
<b>Date of Registration</b>	30/06/2008	
<b>Title</b>	Textile Fabric	
<b>Priority NA</b>		



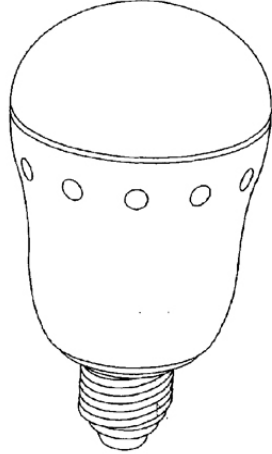

<b>Design Number</b>	216925	
<b>Class</b>	05-05	
<b>1)Biba Apparels Pvt. Ltd.,</b> 45-54, Whitehall Kemps Cornet, 143, A.K.Marg, Mumbai-400 036. Maharashtra, India.		
<b>Date of Registration</b>	30/06/2008	
<b>Title</b>	Textile Fabric	
<b>Priority NA</b>		
<b>Design Number</b>	220014	
<b>Class</b>	26-04	
<b>1)Panasonic Corporation</b> 1006, Oaza Kadoma, Kadoma-shi, Osaka 571-8501, Japan		
<b>Date of Registration</b>	05/12/2008	
<b>Title</b>	Diode Lamp	
<b>Priority NA</b>		
<b>Design Number</b>	220015	
<b>Class</b>	26-04	
<b>1)Panasonic Corporation</b> 1006, Oaza Kadoma, Kadoma-shi, Osaka 571-8501, Japan		
<b>Date of Registration</b>	05/12/2008	
<b>Title</b>	Diode Lamp	
<b>Priority NA</b>		

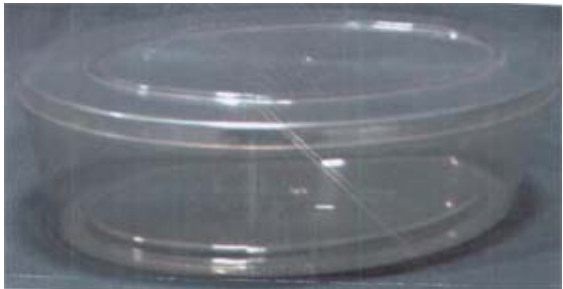

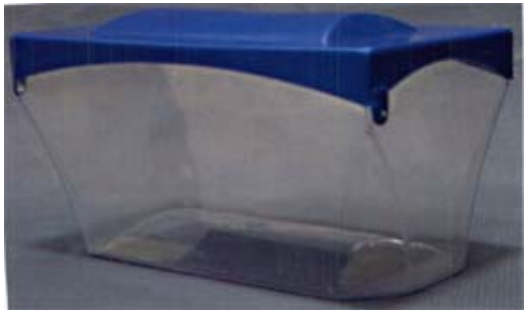
<b>Design Number</b>	220017	
<b>Class</b>	26-04	
<b>1)Panasonic Corporation</b> 1006, Oaza Kadoma, Kadoma-shi, Osaka 571-8501, Japan		
<b>Date of Registration</b>	05/12/2008	
<b>Title</b>	Diode Lamp	
<b>Priority NA</b>		

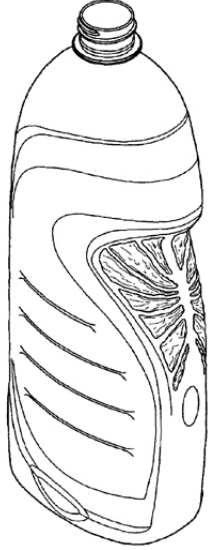
<b>Design Number</b>	220115	
<b>Class</b>	09-03	
<b>1)Arihant Plast</b> K-57, Sonal Heavy Ind. Estate, Kachpada, Malad (W), Mumbai-400064. [Maharashtra] India		
<b>Date of Registration</b>	08/12/2008	
<b>Title</b>	Container	
<b>Priority NA</b>		

<b>Design Number</b>	220116	
<b>Class</b>	09-03	
<b>1)Arihant Plast</b> K-57, Sonal Heavy Ind. Estate, Kachpada, Malad (W), Mumbai-400064. [Maharashtra] India		
<b>Date of Registration</b>	08/12/2008	
<b>Title</b>	Container	
<b>Priority NA</b>		

<b>Design Number</b>	220117	
<b>Class</b>	09-03	
<b>1)Arihant Plast</b> K-57, Sonal Heavy Ind. Estate, Kachpada, Malad (W), Mumbai-400064. [Maharashtra] India		
<b>Date of Registration</b>	08/12/2008	
<b>Title</b>	Container	
<b>Priority NA</b>		
<b>Design Number</b>	220133	
<b>Class</b>	09-01	
<b>1)Hindustan Unilever Limited</b> Hindustan Lever House 165-166 Backbay Reclamation, Mumbai 400020, State of Maharashtra, India		
<b>Date of Registration</b>	10/12/2008	
<b>Title</b>	Bottle	
<b>Priority NA</b>		
<b>Design Number</b>	220164	
<b>Class</b>	23-04	
<b>1)Crompton Greaves Limited.,</b> 6th Floor, C.G. House, Dr Annie Besant Road, Worli, Mumbai-400 030, Maharashtra, India.		
<b>Date of Registration</b>	12/12/2008	
<b>Title</b>	TABLE FAN	
<b>Priority NA</b>		

<b>Design Number</b>	220165	
<b>Class</b>	23-04	
<b>1)Crompton Greaves Limited.,</b> 6th Floor, C.G. House, Dr Annie Besant Road, Worli, Mumbai-400 030, Maharashtra, India.		
<b>Date of Registration</b>	12/12/2008	
<b>Title</b>	Table Fan	
<b>Priority NA</b>		
<b>Design Number</b>	220166	
<b>Class</b>	23-04	
<b>1)Crompton Greaves Limited.,</b> 6th Floor, C.G. House, Dr Annie Besant Road, Worli, Mumbai-400 030, Maharashtra, India.		
<b>Date of Registration</b>	12/12/2008	
<b>Title</b>	Table Fan	
<b>Priority NA</b>		
<b>Design Number</b>	220167	
<b>Class</b>	13-03	
<b>1)Larsen &amp; Toubro Limited</b> L & T House, Ballard Estate, Mumbai-400 001, Maharashtra, India.		
<b>Date of Registration</b>	12/12/2008	
<b>Title</b>	Split Meter	
<b>Priority NA</b>		

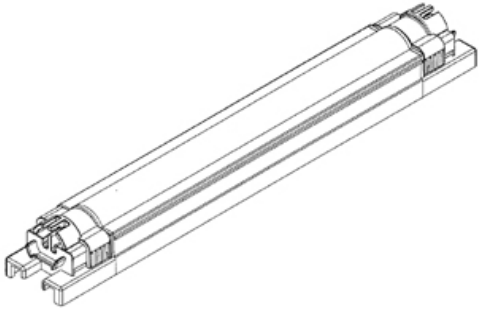
<b>Design Number</b>	220170	
<b>Class</b>	13-03	
<b>1)Larsen &amp; Toubro Limited</b> L & T House, Ballard Estate, Mumbai-400 001, Maharashtra, India.		
<b>Date of Registration</b>	12/12/2008	
<b>Title</b>	Split Meter Unit	
<b>Priority NA</b>		
<b>Design Number</b>	220288	
<b>Class</b>	06-05	
<b>1)Godrej &amp; Boyce Mfg Co Limited</b> Pirojshanagar, Vikhroli, Mumbai 400079, Maharashtra, India		
<b>Date of Registration</b>	17/12/2008	
<b>Title</b>	Desk-Chair Combination	
<b>Priority NA</b>		
<b>Design Number</b>	220400	
<b>Class</b>	26-05	
<b>1)Feelus Co., Ltd.,</b> 624-8, Seogu-ri, Gwangjeok-myeon, Yangju-si, Gyeonggi-do, Republic of Korea.		
<b>Date of Registration</b>	22/12/2008	
<b>Title</b>	Ceiling Light	
<b>Priority NA</b>		

<b>Design Number</b>	221113
<b>Class</b>	13-01
<b>1)Crompton Greaves Limited.,</b> 6th Floor, C.G. House, Dr Annie Besant Road, Worli, Mumbai-400 030, Maharashtra, India.	
<b>Date of Registration</b>	09/02/2009
<b>Title</b>	Alternator
<b>Priority NA</b>	



<b>Design Number</b>	208940	
<b>Class</b>	23-04	
<b>1)Reckitt Benckiser (Uk) Limited</b> 103-105 Bath Road, Slough, Berkshire, SL1 3uh, United Kingdom.		
<b>Date of Registration</b>	19/03/2007	
<b>Title</b>	Air Freshener Device	
<b>Priority</b>		
Priority Number	Date	Country
000592902-0002	21/09/2006	EUROPEAN UNION

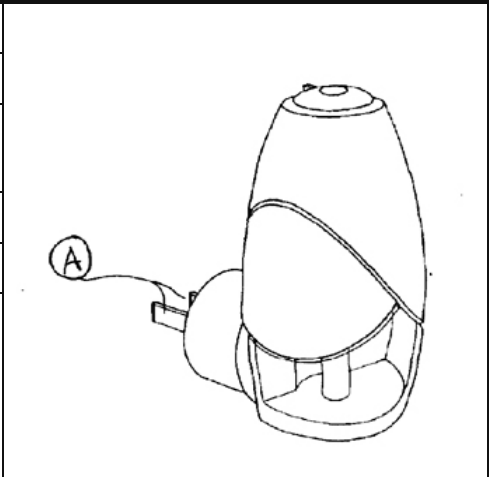

<b>Design Number</b>	208941	
<b>Class</b>	23-04	
<b>1)Reckitt Benckiser (Uk) Limited</b> 103-105 Bath Road, Slough Berkshire, SL1 3UH, United Kingdom		
<b>Date of Registration</b>	19/03/2007	
<b>Title</b>	Air Freshener Device	
<b>Priority</b>		
Priority Number	Date	Country
000592902-0003	21/09/2006	EUROPEAN UNION

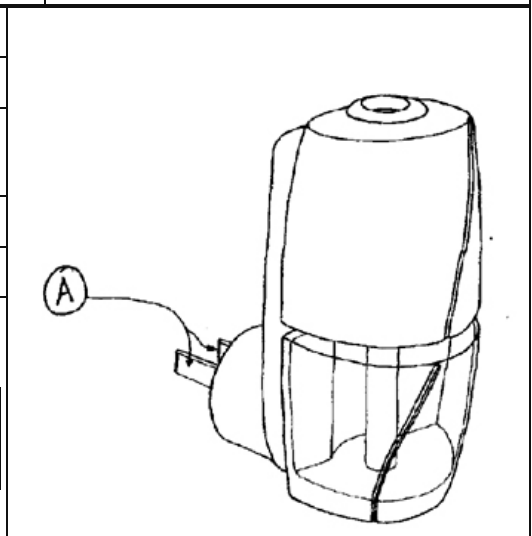

<b>Design Number</b>	208942	
<b>Class</b>	23-04	
<b>1)Reckitt Benckiser (Uk) Limited</b> 103-105 Bath Road, Slough Berkshire, SL1 3UH, United Kingdom		
<b>Date of Registration</b>	19/03/2007	
<b>Title</b>	Air Freshener Device	
<b>Priority</b>		
Priority Number	Date	Country
000592902-0004	21/09/2006	EUROPEAN UNION

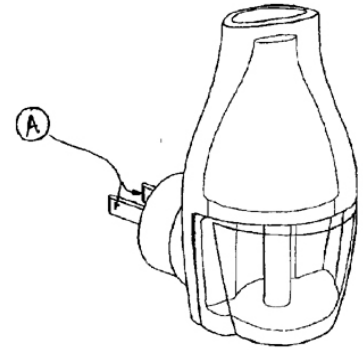

<b>Design Number</b>	208943	
<b>Class</b>	23-04	
<b>1)Reckitt Benckiser (Uk) Limited</b> 103-105 Bath Road, Slough, Berkshire, SL1 3uh, United Kingdom.		
<b>Date of Registration</b>	19/03/2007	
<b>Title</b>	Air Freshener Device	
<b>Priority</b>		
Priority Number	Date	Country
000592902-0005	21/09/2006	EUROPEAN UNION

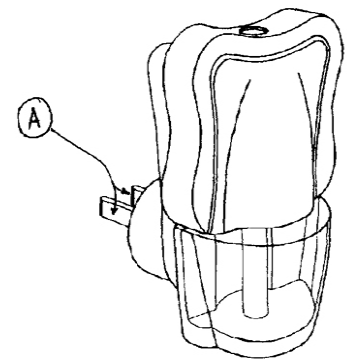

<b>Design Number</b>	208944	
<b>Class</b>	23-04	
<b>1)Reckitt Benckiser (Uk) Limited</b> 103-105 Bath Road, Slough, Berkshire, SL1 3uh, United Kingdom.		
<b>Date of Registration</b>	19/03/2007	
<b>Title</b>	"Air Freshener Device"	
<b>Priority</b>		
Priority Number	Date	Country
000592902-0006	21/09/2006	EUROPEAN UNION

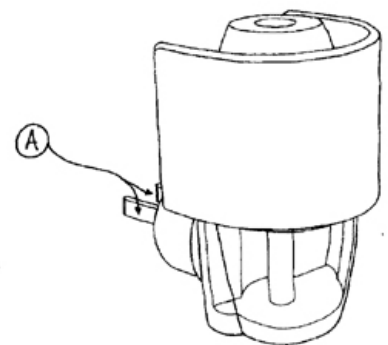

<b>Design Number</b>	208946	
<b>Class</b>	23-04	
<b>1)Reckitt Benckiser (Uk) Limited</b> 103-105 Bath Road, Slough, Berkshire, S11 3uh, United Kingdom.		
<b>Date of Registration</b>	19/03/2007	
<b>Title</b>	Air Freshener Device	
<b>Priority</b>		
Priority Number	Date	Country
000592902-0008	21/09/2006	EUROPEAN UNION

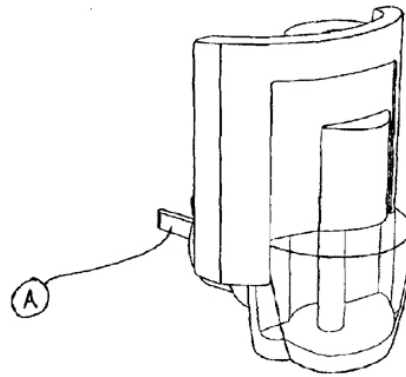

<b>Design Number</b>	221348	
<b>Class</b>	12-08	
<b>1)Gm Global Technology Operations, Inc.,</b> 300 Renaissance Center, Detroit, Michigan 48265-3000, USA.		
<b>Date of Registration</b>	23/02/2009	
<b>Title</b>	Car	
<b>Priority</b>		
Priority Number	Date	Country
30-2008-0042972	06/10/2008	Korea(South)



<b>Design Number</b>	221389	
<b>Class</b>	14-03	
<b>1)SONY ERICSSON MOBILE COMMUNICATIONS AB.,</b> NYA VATTENTORNET, SE-221 88, LUND, SWEDEN.		
<b>Date of Registration</b>	24/02/2009	
<b>Title</b>	Mobile Phone	
<b>Priority</b>		
Priority Number	Date	Country
001003669-0003	16/09/2008	OHIM

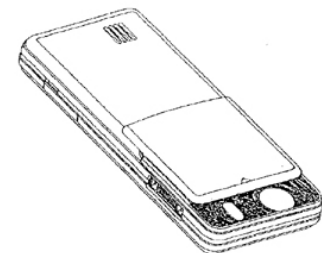





<b>Design Number</b>	221391		
<b>Class</b>	06-01		
<b>1)Isringhausen Gmbh &amp; Co. Kg.,</b> Isringhausen-Ring 58, 32657 Lemgo, Germany.			
<b>Date of Registration</b>	24/02/2009		
<b>Title</b>	Seat		
<b>Priority</b>			
Priority Number	Date	Country	
000994744	01/09/2008	EUROPEAN UNION	
<b>Design Number</b>	221718		
<b>Class</b>	13-01		
<b>1)Crompton Greaves Limited.,</b> 6th Floor, C.G. House, Dr Annie Besant Road, Worli, Mumbai-400 030, Maharashtra, India.			
<b>Date of Registration</b>	17/03/2009		
<b>Title</b>	"ALTERNATOR"		
<b>Priority NA</b>			
<b>Design Number</b>	219691		
<b>Class</b>	12-08		
<b>1)Toyota jidosha Kabushiki Kaisha</b> 1, Toyota-cho, Toyota-shi, Aichi-ken, 471-8571, Japan			
<b>Date of Registration</b>	14/11/2008		
<b>Title</b>	Automobile		
<b>Priority NA</b>			

<b>Design Number</b>	219708	
<b>Class</b>	05-05	
<b>1)Charming Apparels (P) Ltd.,</b> 402-405, 1st Floor, Main Road, Chandni Chowk, Delhi-110006, India		
<b>Date of Registration</b>	17/11/2008	
<b>Title</b>	"TEXTILE FABRIC"	
<b>Priority NA</b>		
<b>Design Number</b>	219710	
<b>Class</b>	05-05	
<b>1)Charming Apparels (P) Ltd.,</b> 402-405, 1st Floor, Main Road, Chandni Chowk, Delhi-110006, India		
<b>Date of Registration</b>	17/11/2008	
<b>Title</b>	"TEXTILE FABRIC"	
<b>Priority NA</b>		
<b>Design Number</b>	219711	
<b>Class</b>	05-05	
<b>1)CHARMING APPARELS (P) LTD.</b> 402-405, 1st Floor, Main Road, Chandni Chowk, Delhi-110006, India <b>2)Charming Apparels (P) Ltd.,</b>		
<b>Date of Registration</b>	17/11/2008	
<b>Title</b>	"TEXTILE FABRIC"	
<b>Priority NA</b>		

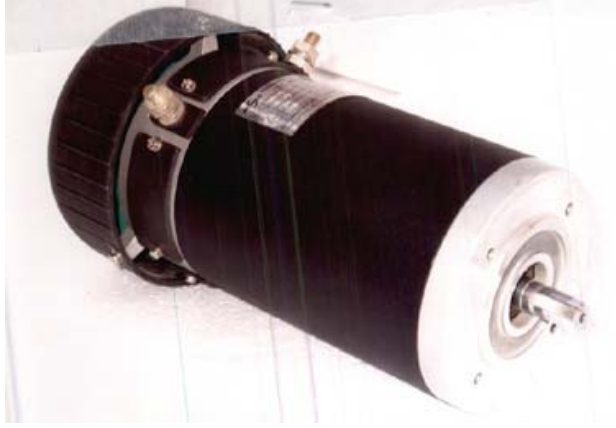
<b>Design Number</b>	219712	
<b>Class</b>	05-05	
<b>1)Charming Apparels (P) Ltd.,</b> 402-405, 1st Floor, Main Road, Chandni Chowk, Delhi-110006, India		
<b>Date of Registration</b>	17/11/2008	
<b>Title</b>	"TEXTILE FABRIC"	
<b>Priority NA</b>		
<b>Design Number</b>	219713	
<b>Class</b>	05-05	
<b>1)Charming Apparels (P) Ltd.,</b> 402-405, 1st Floor, Main Road, Chandni Chowk, Delhi-110006, India		
<b>Date of Registration</b>	17/11/2008	
<b>Title</b>	"TEXTILE FABRIC"	
<b>Priority NA</b>		
<b>Design Number</b>	219714	
<b>Class</b>	05-05	
<b>1)Charming Apparels (P) Ltd.,</b> 402-405, 1st Floor, Main Road, Chandni Chowk, Delhi-110006, India		
<b>Date of Registration</b>	17/11/2008	
<b>Title</b>	TEXTILE FABRIC	
<b>Priority NA</b>		

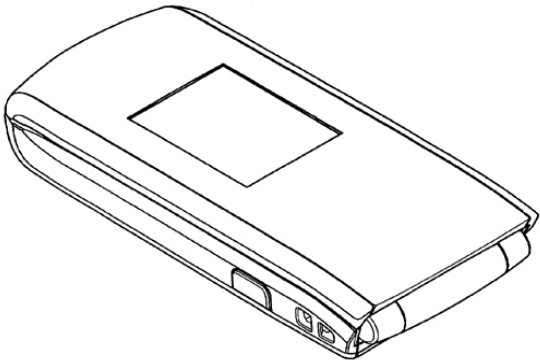
<b>Design Number</b>	219740		
<b>Class</b>	13-01		
<b>1)Rotomag Motors &amp; Controls Pvt. Ltd.,</b> 7/C, Vitthal Udyognagar, Nr. Anand-388121. Gujarat-India			
<b>Date of Registration</b>	18/11/2008		
<b>Title</b>	Low Voltage Motor		
<b>Priority NA</b>			
<b>Design Number</b>	219791		
<b>Class</b>	23-04		
<b>1)Adoni Iftekhar Akbar</b> S.No.202/1, Plot No.8 Opp, Aga Khan Palace Sukun Bungalow Nagar Road Pune-411006, Maharashtra, India <b>2)Shaikh Nisar Abdul Karim</b>			
<b>Date of Registration</b>	21/11/2008		
<b>Title</b>	Air Conditioner for Bus		
<b>Priority NA</b>			
<b>Design Number</b>	219914		
<b>Class</b>	14-03		
<b>1)Nokia Corporation</b> Keilalahdentie 4 Fin-02150 Espoo Finland			
<b>Date of Registration</b>	28/11/2008		
<b>Title</b>	Handset		
<b>Priority</b>			
<b>Priority Number</b>	<b>Date</b>	<b>Country</b>	
29/325,531	02/10/2008	U.S.A.	