



CONTINUED FROM PART- 1



INTRODUCTION

In view of the recent amendment made in the Designs (Amendment) Rules, 2008 with effect from 17/06/2008, Publication of the matter relating to Designs is being published in the Official Journal of The Patent Office. This Journal is being published on weekly basis on every Friday covering the various proceedings on Designs as required according to the provisions of under Rule 22, 25, 27 and 39 of the Design (Amendment) Rules, 2008. All the enquiries on this Official Journal and other information as required by the public should be addressed to the Controller General of Patents, Designs & Trade Marks. Suggestions and comments are requested from all quarters so that the content can be enriched.

REGISTRATION OF DESIGNS

The following designs have been registered. They are now open for public inspection. In the following each entry the Date of Registration is shown. The Priority Number, Priority Date and Priority Country are also shown

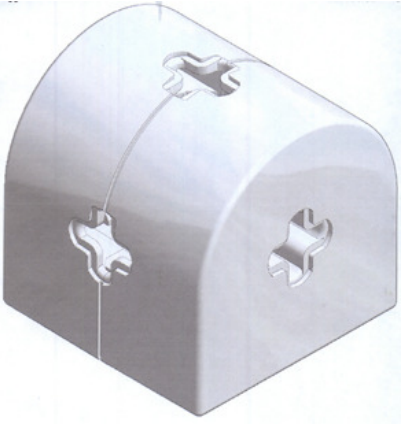
Design Number	219423	
Class	28-03	
1)S. B. International 413-414, Imperial Towers, C-Block Community Center Naraina Vihar, New Delhi-110028, India		
Date of Registration	23/10/2008	
Title	Thumb/Fingure Mixing Pallate	
Priority NA		
Design Number	219493	
Class	05-05	
1)Charming Apparels (P) Ltd., 402-405, 1st Floor, Main Road, Chandni Chowk, Delhi-110006, India		
Date of Registration	30/10/2008	
Title	Textile Fabric	
Priority NA		
Design Number	219494	
Class	05-05	
1)Charming Apparels (P) Ltd., 402-405, 1st Floor, Main Road, Chandni Chowk, Delhi-110006, India		
Date of Registration	30/10/2008	
Title	TEXTILE FABRIC	
Priority NA		

Design Number	219501		
Class	21-01		
1)3L-Rask Aps Vibaekvej 100, Brylle, 5690 Tommerup, Denmark			
Date of Registration	31/10/2008		
Title	Building Bricks		
Priority			
Priority Number	Date	Country	
000927850-0004	02/05/2008	OHIM	
Design Number	215079		
Class	12-15		
1)Tvs Srichakra Limited., 7b, West Veli Street, Madurai 625 001, Tamil Nadu, India.			
Date of Registration	03/03/2008		
Title	Tyre		
Priority NA			
Design Number	215084		
Class	07-01		
1)Eicher Goodearth Limited., Eicher House, 12 Commercial Complex, Greater Kailash-II (Masjid Moth), New Delhi-110 048, India.			
Date of Registration	03/03/2008		
Title	Plate		
Priority NA			

Design Number	217594	
Class	14-03	
1)Nokia Corporation Keilalahdentie 4 Fin-02150 Espoo Finland		
Date of Registration	07/08/2008	
Title	Handset	
Priority		
Priority Number	Date	Country
29/303, 529	11/02/2008	U.S.A.

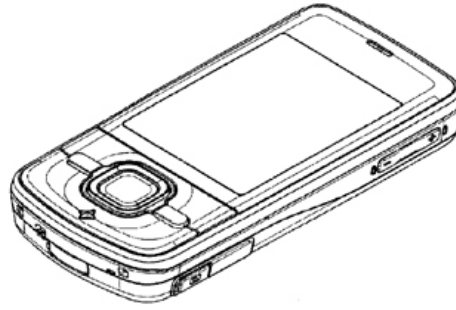





Design Number	220713	
Class	30-03	
1)SHRI MUNIT KUMAR & SHRI DEVINDER KUMAR., A-98/1, WAZIRPUR INDUSTRIAL AREA, DELHI-110052, INDIA. 2)Shri Munit Kumar & Shri Devinder Kumar.,		
Date of Registration	07/01/2009	
Title	Bowl For Dog Feeding	
Priority NA		

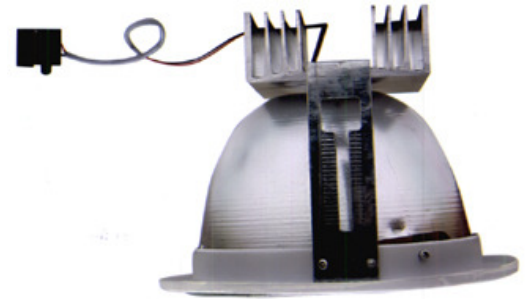

Design Number	220756	
Class	26-03	
1)Crompton Greaves Limited., 6th Floor, C.G. House, Dr Annie Besant Road, Worli, Mumbai- 400 030, Maharashtra, India.		
Date of Registration	13/01/2009	
Title	Lighting Fixture	
Priority NA		

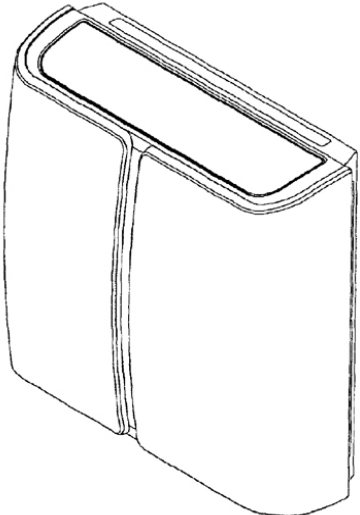
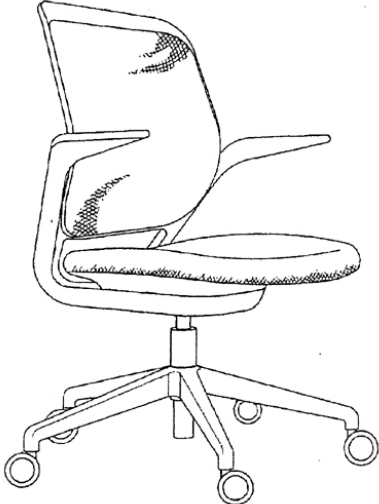

Design Number	220767	
Class	25-04	
1)SANGAM PUSHPAVATHI., DOOR NO.-2-2-647/A/30, SAI BABA NAGAR, NEW NALLAKUNTA, HYDERABD 13, AP, INDIA. 2)Sangam Pushpavathi.,		
Date of Registration	14/01/2009	
Title	Supplement To An Existing Staircase	
Priority NA		
Design Number	220880	
Class	07-01	
1)Glen Appliances Pvt. Ltd., 1-34, Dlf Industrial Area, Phase-1, Faridabad-121 003, Haryana, India.		
Date of Registration	21/01/2009	
Title	Jar For Mixer Grinder	
Priority NA		
Design Number	206162	
Class	08-09	
1)Ebco Pvt. Ltd., SakiVihar Road, Mumbai-400072, Maharashtra, India		
Date of Registration	03/10/2006	
Title	Furniture Joinery Fitting (Set)	
Priority NA		

Design Number	219672		
Class	23-04		
1)Lg Electronics Inc., 20, Yoido-Dong, Yongdungpo-Gu, Seoul, Republic of Korea			
Date of Registration	12/11/2008		
Title	Cool Air Circulator		
Priority			
Priority Number	Date	Country	
30-2008-0020745	16/05/2008	Republic of Korea	
Design Number	219868		
Class	06-01		
1)Steelcase, Inc., CD.6W.02 P.O. Box 1967, Grand Rapids, MI 49501-1967, USA			
Date of Registration	25/11/2008		
Title	Seating Unit		
Priority			
Priority Number	Date	Country	
29/318, 691	26/05/2009	U.S.A.	
Design Number	219970		
Class	26-02		
1)H.P. Industries (India) 107, Anarkali Extension, Parwana Road Delhi-110051. (India)			
Date of Registration	03/12/2008		
Title	Torch		
Priority NA			

Design Number	218426	
Class	24-01	
1)Societe Pour La Conception Des Applications Des Techniques Electroniques-Satelec A Venue Gustave Eiffel-ZI Du Phare 33700 Merignac France		
Date of Registration	05/09/2008	
Title	Tips For Dental Use	
Priority		
Priority Number	Date	Country
081181	06/03/2008	France

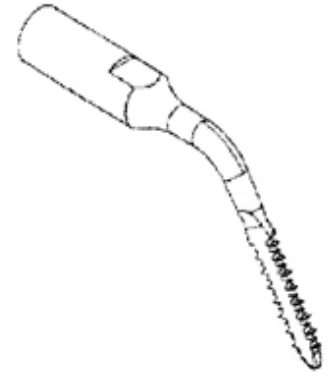

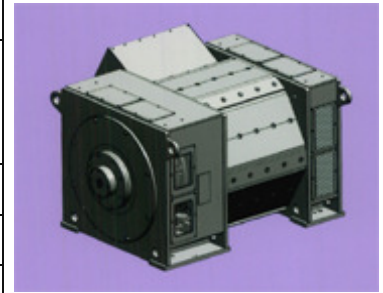

Design Number	222189	
Class	13-99	
1)Crompton Greaves Limited., 6th Floor, Cg House, Dr Annie Besant Road, Worli, Mumbai-400 030, Maharashtra, India.		
Date of Registration	31/03/2009	
Title	Terminal Box	
Priority NA		





Design Number	222201	
Class	26-03	
1)Crompton Greaves Limited., 6th Floor, Cg House, Dr Annie Besant Road, Worli, Mumbai-400 030, Maharashtra, India.		
Date of Registration	31/03/2009	
Title	Lamp	
Priority NA		



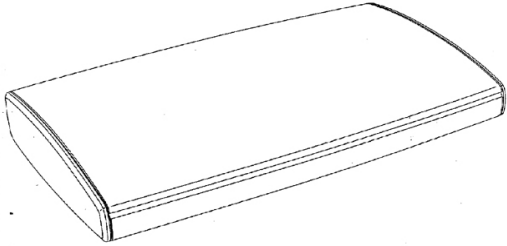

Design Number	218657		
Class	10-02		
1)Technomarine SA, Rue de la Rotisserie 2, 1204 Geneva/Switzerland			
Date of Registration	19/09/2008		
Title	Wrist Watch		
Priority			
Priority Number	Date	Country	
135010	04/04/2008	Switzerland	

Design Number	221786		
Class	23-01		
1)Hansgrohe AG., Austr. 5-9, D-77761 Schiltach, Germany.			
Date of Registration	19/03/2009		
Title	Sanitary Fitting		
Priority			
Priority Number	Date	Country	
001011415-0004	26/09/2008	OHIM	

Design Number	222004		
Class	14-01		
1)Bose Corporation The Mountain, Framingham, Ma 01701-9168, Usa.			
Date of Registration	27/03/2009		
Title	Audio/Video Switchbox		
Priority			
Priority Number	Date	Country	
29/326,071	10/10/2008	U.S.A.	

Design Number	216007		
Class	14-03		
1)Khanna Industries., B-75, 2nd Floor, (Back Side), Industrial Area, G.T.Karnal Road, Delhi-110 033, India.			
Date of Registration	24/04/2008		
Title	Modem Splitter Holder		
Priority NA			
Design Number	219006		
Class	02-02		
1)Charming Apparels (P) Ltd., 402-405, 1st Floor, Main Road, Chandni Chowk, Delhi-110006, India			
Date of Registration	06/10/2008		
Title	Dress Material		
Priority NA			
Design Number	221339		
Class	15-09		
1)Leister Process Technologies., Galileostrasse 10, Ch-6056 Kaegiswil, Switzerland.			
Date of Registration	20/02/2009		
Title	Hot Air Tool		
Priority			
Priority Number	Date	Country	
001075238	26/01/2009	OHIM	

Design Number	221407		
Class	26-06		
1)Honda Motor Co., Ltd., 1-1, Minami-Aoyama 2-Chome, Minato-Ku, Tokyo, Japan.			
Date of Registration	26/02/2009		
Title	Lamp for Automobile		
Priority			
Priority Number	Date	Country	
2008-022169	28/08/2008	Japan	
Design Number	221408		
Class	12-08		
1)Honda Motor Co., Ltd., 1-1, Minami-Aoyama 2-Chome, Minato-Ku, Tokyo, Japan.			
Date of Registration	26/02/2009		
Title	Automobile		
Priority			
Priority Number	Date	Country	
2008-022230	29/08/2008	Japan	
Design Number	221586		
Class	26-05		
1)Ge India Industrial Pvt. Ltd., Plot No. 42/1, & 45/14, Electronic City Phase 11, Bangalore-560100, Karnataka, India.			
Date of Registration	09/03/2009		
Title	"WALL MOUNT LIGHTING"		
Priority NA			



Design Number	221733		
Class	23-02		
1)Hansgrohe AG., Auestr. 5-9, D-77761 Schiltach, Germany.			
Date of Registration	17/03/2009		
Title	Napkin Holder		
Priority			
Priority Number	Date	Country	
001007314-0005	23/09/2008	OHIM	

Design Number	212672		
Class	13-03		
1)Crompton Greaves Limited., 6th Floor, Cg House, Dr Annie Besant Road, Worli, Mumbai-400 030, Maharashtra, India.			
Date of Registration	26/09/2007		
Title	Vacuum Interrupter		
Priority NA			

Design Number	220917		
Class	23-01		
1)Klaus Waren Fixtures Pvt. Ltd., 285, Park View, 1st Floor, Flat No. 9, B.A.K Anjan Marg, Opp. Napoo Garden, Matunga (Central Railway) (E), Mumbai-400 019, Maharashtra, India.			
Date of Registration	23/01/2009		
Title	Toilet Tap.		
Priority NA			

Design Number	221098		
Class	02-03		
1)MR. ASHISH ANAND., C-102, SILVER AKRUTHI APARTMENT, 27TH MAIN, SECTOR-2, ADJACENT TO PARANGIPALYA KPTCL POWER GRID STAION, BANGALORE-560095, INDIA. 2)Mr. Ashish Anand.,			
Date of Registration	09/02/2009		
Title	Head Cum Face Wear		
Priority NA			
Design Number	221242		
Class	23-02		
1)Hindustan Sanitaryware & Industries Limited., Bahadurgarh-124507, Dist. Jhajjar, Haryana, India.			
Date of Registration	16/02/2009		
Title	Wash Basin		
Priority NA			
Design Number	213595		
Class	14-03		
1)Motorola, Inc., 1303 East Algonquin Road, Schaumburg, Illinois 60196, USA.			
Date of Registration	30/11/2007		
Title	Housing For A Communication Device		
Priority			
Priority Number	Date	Country	
29/281,712	29/06/2007	U.S.A.	

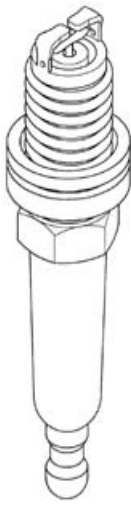
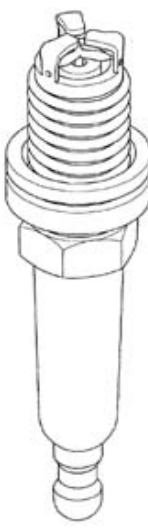
Design Number	216927	
Class	05-05	
1)Biba Apparels Pvt. Ltd., 45-54, Whitehall, Kemps Corner, 143, A.K.Marg, Mumbai-400 036. Maharashtra, India.		
Date of Registration	30/06/2008	
Title	Textile Fabric	
Priority NA		
Design Number	220118	
Class	09-03	
1)Arihant Plast K-57, Sonal Heavy Ind. Estate, Kachpada, Malad (W), Mumbai-400064. [Maharashtra] India		
Date of Registration	08/12/2008	
Title	Contianer	
Priority NA		
Design Number	220139	
Class	15-05	
1)Bry-Air Asia Pvt. Ltd., 20 Rajpur Road, Delhi-110054, India		
Date of Registration	11/12/2008	
Title	Dehumidifier`	
Priority NA		

Design Number	220154		
Class	15-01		
1)Jun, Byoung Pyo LG 1 Apartment 104-202, Sungbok-Dong, Sugi-Gu, Gyeonggi-Do, Korea			
Date of Registration	11/12/2008		
Title	Ignition Plug for Internal Combustion Engine		
Priority			
Priority Number	Date	Country	
30-2008-24894	11/06/2008	Republic of Korea	
Design Number	220156		
Class	15-01		
1)Jun, Byoung Pyo LG 1 Apartment 104-202, Sungbok-Dong, Sugi-Gu, Gyeonggi-Do, Korea			
Date of Registration	11/12/2008		
Title	Ignition Plug for Internal Combustion Engine		
Priority			
Priority Number	Date	Country	
30-2008-24895	11/06/2008	Republic of Korea	
Design Number	220243		
Class	11-01		
1)Jewelex India Pvt. Ltd., Plot 56 B, Seepz, Andheri East, Mumbai-400096, India			
Date of Registration	16/12/2008		
Title	Gem Stone		
Priority NA			

Design Number	220291	
Class	13-03	
1)Anderson Power Products, Inc., 13 Pratts Junction Road, Sterling Ma 01564 United States of America		
Date of Registration	17/12/2008	
Title	Electrical Connector	
Priority		
Priority Number	Date	Country
29/324, 296	10/09/2008	U.S.A.

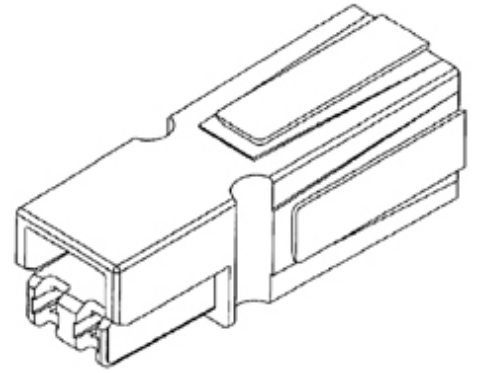

Design Number	220420	
Class	15-01	
1)Emerson Climate Technologies India Limited 1202/1201, Ghole Road, Shivaji Nagar, Pune-411 004, Maharashtra, India		
Date of Registration	23/12/2008	
Title	Discharge Muffler Assembly	
Priority NA		

