

CONTINUED FROM PART 1



INTRODUCTION

In view of the recent amendment made in the Designs (Amendment) Rules, 2008 with effect from 17/06/2008, Publication of the matter relating to Designs is being published in the Official Journal of The Patent Office. This Journal is being published on weekly basis on every Friday covering the various proceedings on Designs as required according to the provisions of under Rule 22, 25, 27 and 39 of the Design (Amendment) Rules, 2008. All the enquiries on this Official Journal and other information as required by the public should be addressed to the Controller General of Patents, Designs & Trade Marks. Suggestions and comments are requested from all quarters so that the content can be enriched.

REGISTRATION OF DESIGNS

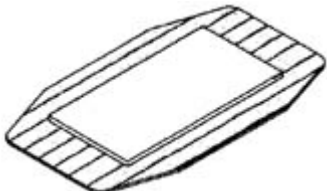
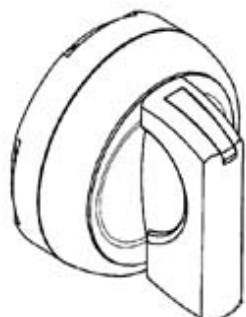
The following designs have been registered. They are now open for public inspection. In the following each entry the Date of Registration is shown. The Priority Number, Priority Date and Priority Country are also shown

Design Number	206255			
Class	14-03			
1)Nokia Corporation., Keilalahdentie 4, Fin-02150 Espoo, Finland.				
Date of Registration	03/04/2006			
Title	Handset			
Priority				
Priority Number	Date	Country		
29/246,359	03/04/2006	U.S.A.		
Design Number	207392			
Class	24-04			
1)3M Innovative Properties Company 3M Center, Saint Paul, Minnesota 55133-3427, U.S.A.				
Date of Registration	12/12/2006			
Title	Bandage			
Priority				
Priority Number	Date	Country		
29/261,302	12/06/2006	U.S.A.		
Design Number	207403			
Class	13-03			
1)Legrand France 128 Avenue Du Marechal DE Lattre-DE-Tassigny, FR-87000 Limoges, France 2)Legrand SNC				
Date of Registration	12/06/2006			
Title	Electrical Energy Control Switch			
Priority				
Priority Number	Date	Country		
000545603	12/06/2006	OHIM		

Design Number	207404		
Class	13-03		
1)Legrand France 128 Avenue Du Marechal DE Lattre-DE-Tassigny, FR-87000 Limoges, France 2)Legrand SNC.,			
Date of Registration	12/12/2006		
Title	Electrical Energy Control Switch		
Priority			
Priority Number	Date	Country	
000545603	12/06/2006	OHIM	
Design Number	207416		
Class	14-03		
1)Nokia Corporation., Keilalahdentie 4, Fin-02150 Espoo, Finland.			
Date of Registration	14/06/2006		
Title	Handset		
Priority			
Priority Number	Date	Country	
M20060130	14/06/2006	Finland	
Design Number	208980		
Class	15-99		
1)Elettrotecnica B.C. S.P.A. Via Indipendenza, 42 27029 Vigevano (Pavia), Italy.			
Date of Registration	20/03/2007		
Title	Assembly Machines For Foot Wear		
Priority			
Priority Number	Date	Country	
000606926	19/10/2006	EUROPEAN UNION	

Design Number	209705	
Class	13-02	
1)Semi-Photonics Co., Ltd 8F, No. 13 Ke Jung Road, Chu-Nan Site, Hsinchu Science Park, Chu-Nan 350, Taiwan, R.O.C.		
Date of Registration	12/04/2007	
Title	Light Emitting Diode	
Priority		
Priority Number	Date	Country
29,278,104	20/03/2007	U.S.A.

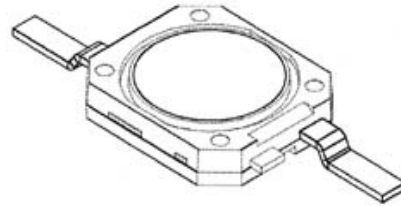





Design Number	211957	
Class	11-01	
1)PUNITA TRRIKHA S-69, GREATER KAILASH, PART-1 2)Punita Trrikha		
Date of Registration	20/08/2007	
Title	Necklace	
Priority NA		

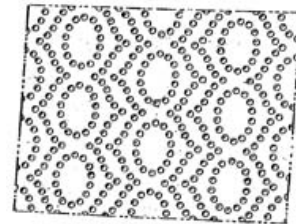



Design Number	212902	
Class	05-05	
1)McNeil PPC, INC 199 Grandview Road, Skillman, NJ 08558, USA		
Date of Registration	11/10/2007	
Title	Cover Material for a Sanitary Napkin	
Priority		
Priority Number	Date	Country
29/279,317	26/04/2007	U.S.A.

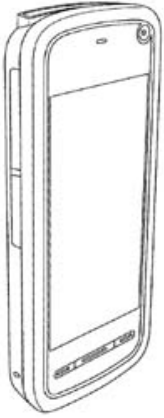
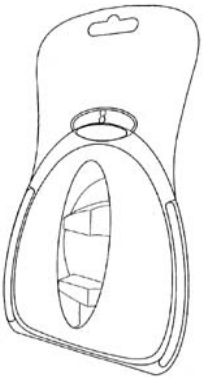

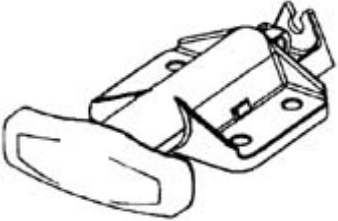

Design Number	214628		
Class	09-01		
1)Reckitt Benckiser N.V., Siriusdreef 14, 2132 WT Hoofddorp, Netherlands.			
Date of Registration	08/02/2008		
Title	Bottle With Cap		
Priority			
Priority Number	Date	Country	
000771712-0002	09/08/2007	OHIM	
Design Number	214919		
Class	14-03		
1)Apple Inc., 1 Infinite Loop, Cupertino, California 95014 USA			
Date of Registration	27/02/2008		
Title	Electronic Device		
Priority			
Priority Number	Date	Country	
29/284,187	31/08/2007	U.S.A.	
Design Number	214920		
Class	14-03		
1)Apple Inc., 1 Infinite Loop, Cupertino, California 95014 USA			
Date of Registration	27/02/2008		
Title	Electronic Device		
Priority			
Priority Number	Date	Country	
29/284,187	31/08/2007	U.S.A.	

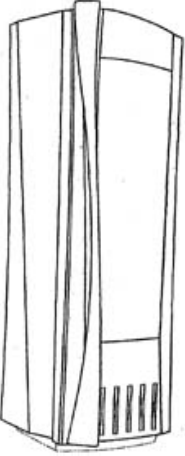
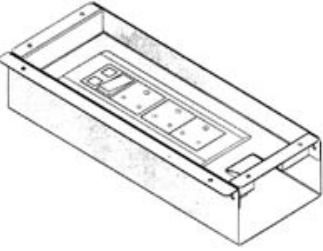

Design Number	216466		
Class	14-03		
1)Nokia Corporation., Keilalahdentie 4, Fin-02150 Espoo, Finland.			
Date of Registration	28/05/2008		
Title	Handset		
Priority			
Priority Number	Date	Country	
29/298,347	03/12/2007	U.S.A.	
Design Number	216822		
Class	09-03		
1)Reckitt Benckiser (U. K.) Limited 103-105 Bath Road, Slough, Berkshire, SL1 3UH, UK			
Date of Registration	20/06/2008		
Title	Packaging Of Cosmetic Products		
Priority			
Priority Number	Date	Country	
000846902-0001	20/12/2007	OHIM	
Design Number	216928		
Class	05-05		
1)Biba Apparels Pvt. Ltd., 45-54, "Whitehall", Kemps Corner, 143, A.K.Marg, Mumbai-400 036. Maharashtra, India.			
Date of Registration	30/06/2008		
Title	Textile Fabric		
Priority NA			

Design Number	216930		
Class	05-05		
1)Biba Apparels Pvt. Ltd., 45-54, "Whitehall", Kemps Corner, 143, A.K.Marg, Mumbai-400 036. Maharashtra, India.			
Date of Registration	30/06/2008		
Title	Textile Fabric		
Priority NA			
Design Number	217225		
Class	08-06		
1)Southco, Inc. 210N, Brinton Lake Road, P.O. Box 0116, Concordville, PA 19331-0116, US			
Date of Registration	18/07/2008		
Title	T -Handle Actuator		
Priority			
Priority Number	Date	Country	
29/304,923	10/03/2008	U.S.A.	
Design Number	218129		
Class	02-04		
1)Liberty Shoes Limited, Liberty Puram, 13, Milestone, GT Karnal Road, Kutail, DT-Karnal- 132001, Haryana, India			
Date of Registration	26/08/2008		
Title	Footwear		
Priority NA			

Design Number	218130		
Class	02-04		
1)Liberty Shoes Limited, Liberty Puram, 13, Milestone, GT Karnal Road, Kutail, DT-Karnal-132001, Haryana, India			
Date of Registration	26/08/2008		
Title	Footwear		
Priority NA			
Design Number	218359		
Class	24-04		
1)Glaxo Group Limited Glaxo Wellcome House, Berkeley Avenue, Greenford, Middlesex, UB6 0NN, UK			
Date of Registration	14/08/2008		
Title	Mouthpiece For Inhaler		
Priority			
Priority Number	Date	Country	
4006	18/02/2008	U.K.	
Design Number	218368		
Class	08-05		
1)Frank Lian Lyder Sagensgt. 20, N-5008 Bergen, Norway 2)Tor Andre Skeie			
Date of Registration	05/09/2008		
Title	Silicone Remover		
Priority			
Priority Number	Date	Country	
29/304,747	07/03/2008	U.S.A.	

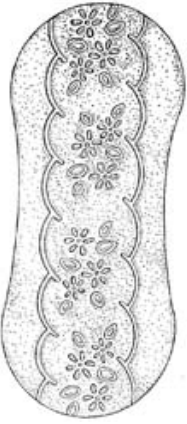
Design Number	219396		
Class	07-01		
1)The Coca Cola Company One Coca-Cola Plaza, N.W. Atlanta, Georgia 30313, USA			
Date of Registration	22/10/2008		
Title	Cooler		
Priority			
Priority Number	Date	Country	
29/317,697	05/05/2008	U.S.A.	
Priority NA			
Priority			
Design Number	219417		
Class	13-03		
1)Wipro Limited., Doddakannelli , Sarjapur Road, Bangalore-560 035, Karnataka, India.			
Date of Registration	23/10/2008		
Title	Flip Top Box		
Priority NA			
Design Number	219526		
Class	09-05		
1)Haresh Kishinchand Karamchandani 126-B, Avinash Building, J.P. Road, Seven Bungalows, Andheri (West), Mumbai 400 058, India			
Date of Registration	04/11/2008		
Title	Case for Keeping Garments		
Priority NA			

Design Number	219560		
Class	24-04		
1)McNeil PPC, INC 199 Grandview Road, Skillman, NJ 08558, USA			
Date of Registration	05/11/2008		
Title	Embossed Absorbent Article		
Priority			
Priority Number	Date	Country	
29/317,676	05/05/2008	U.S.A.	
Design Number			
219561			
Class	24-04		
1)McNeil PPC, INC 199 Grandview Road, Skillman, NJ 08558, USA			
Date of Registration	05/11/2008		
Title	Embossed Absorbent Article		
Priority			
Priority Number	Date	Country	
29/317,675	05/05/2008	U.S.A.	
Design Number			
219602			
Class	11-01		
1)De Beers Centenary AG Alpenstrasse 5, 6000 Luzern 6, Switzerland			
Date of Registration	07/11/2008		
Title	Pendant		
Priority			
Priority Number	Date	Country	
000963673	02/07/2008	OHIM	

Design Number	219638		
Class	07-01		
1)Eicher Goodearth Private Limited., 12 Commercial Complex, Greater Kailash, Part-II, (Masjid Moth), New Delhi-110048, India			
Date of Registration	11/11/2008		
Title	Cup		
Priority NA			
Design Number	219693		
Class	14-03		
1)Plantronics Inc. 345 Encinal Street, Santa Cruz, CA 95060, USA			
Date of Registration	14/11/2008		
Title	Communications Headset		
Priority			
Priority Number	Date	Country	
29/318,391	19/05/2008	U.S.A.	
Design Number	219915		
Class	14-03		
1)Nokia Corporation., Keilalahdentie 4, Fin-02150 Espoo, Finland.			
Date of Registration	28/11/2008		
Title	Handset		
Priority			
Priority Number	Date	Country	
29/319,009	02/06/2008	U.S.A.	

Design Number	219973	
Class	24-02	
1)Bayer Health Care LLC 555 White Plains Road, Tarrytown, New York 10591, USA		
Date of Registration	02/12/2008	
Title	Lancing Device	
Priority		
Priority Number	Date	Country
USSN 29/308,253	05/06/2008	U.S.A.



Design Number	220235	
Class	24-02	
1)GE Healthcare Bio-Sciences AB Bjorkgatan 30, SE-75184 Uppasala, Sweden		
Date of Registration	16/12/2008	
Title	Magnetic Rack	
Priority		
Priority Number	Date	Country
4008174	30/06/2008	U.K.

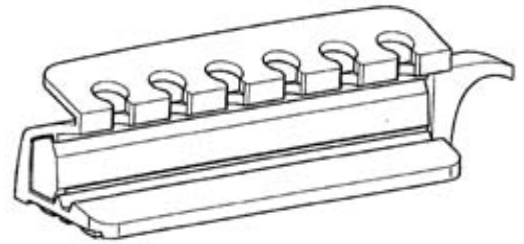



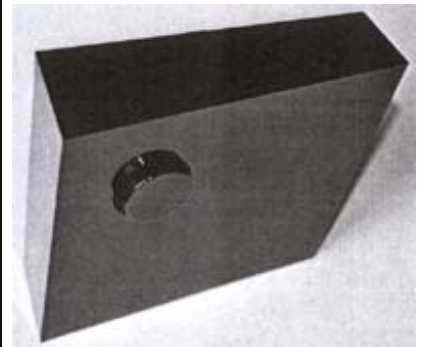

Design Number	220435	
Class	13-03	
1)Flos S.P.A. Via A. Faini, 2, I-25073 Bovezzo, Brescia, Italy		
Date of Registration	23/12/2008	
Title	Switch Box	
Priority		
Priority Number	Date	Country
463868101	14/10/2008	WIPO

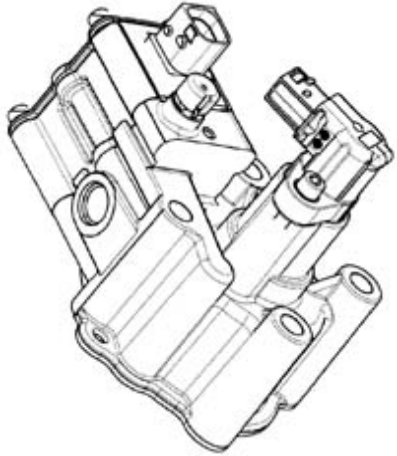
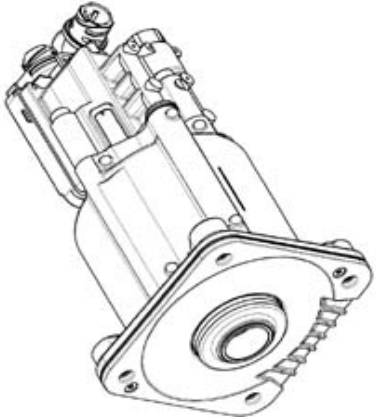
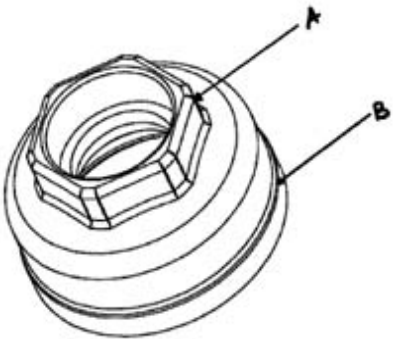

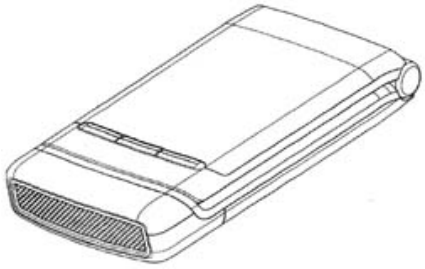

Design Number	220551		
Class	07-01		
1)MA Design India Private Limited C-26, Sector 63, Noida-201301, U.P., India			
Date of Registration	29/12/2008		
Title	LID		
Priority NA			
Design Number	220553		
Class	07-01		
1)MA Design India Private Limited C-26, Sector 63, Noida-201301, U.P., India			
Date of Registration	29/12/2008		
Title	Bowl		
Priority NA			
Design Number	220679		
Class	03-01		
1)Gripping Eyewear, Inc., 10430 Kirkwood, Suite 150, Houston, TX 77099, USA.			
Date of Registration	06/01/2009		
Title	Folded Protective Wrap for Eyeglasses		
Priority			
Priority Number	Date	Country	
29320917	08/07/2008	U.S.A.	

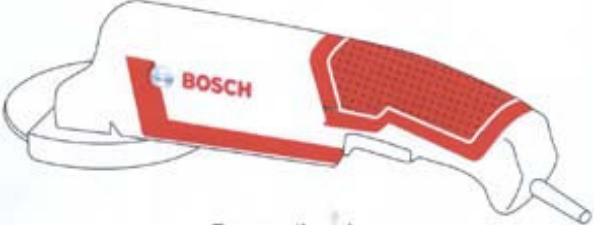

Design Number	220734		
Class	12-16		
1)Wabco Gmbh., Am Lindener Hafen 21, 30453, Hannover, Germany.			
Date of Registration	09/01/2009		
Title	Split Cylinder		
Priority			
Priority Number	Date	Country	
DE 40 2008 003 258.6	10/07/2008	Germany	
Design Number	220736		
Class	12-16		
1)Wabco Gmbh., Am Lindener Hafen 21, 30453, Hannover, Germany.			
Date of Registration	09/01/2009		
Title	Pneumatic Clutch Actuator		
Priority			
Priority Number	Date	Country	
DE 40 2008 003 254.3	10/07/2008	Germany	
Design Number	220773		
Class	23-01		
1)Watertec (Malaysia) Sdn Bhd., Lot 6 Jalan Halba 16/16, Section 16, 40200 Shah Alam, Selangor, Malaysia.			
Date of Registration	14/01/2009		
Title	Bonnet		
Priority NA			

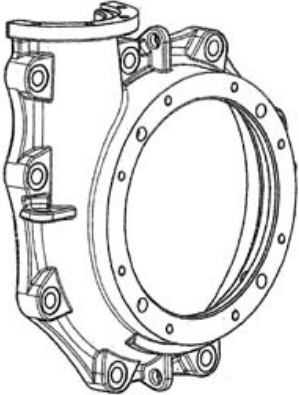

Design Number	220794		
Class	14-03		
1)Nokia Corporation., Keilalahdentie 4, Fin-02150 Espoo, Finland.			
Date of Registration	15/01/2009		
Title	Handset		
Priority			
Priority Number	Date	Country	
29/321,571	18/07/2008	U.S.A.	
Design Number	220836		
Class	12-11		
1)Bajaj Auto Limited New No. 6, Old No. 157, II Floor, Habibullah Road, T. Nagar, Chennai-600017, Tamil Nadu, India			
Date of Registration	19/01/2009		
Title	Motorcycle		
Priority NA			
Design Number	220858		
Class	05-05		
1)Charming Apparels (P) Ltd., 402-405, 1st Floor, Main Road, Chandni Chowk, Delhi-110006, India			
Date of Registration	20/01/2009		
Title	Textile Fabric		
Priority NA			



Design Number	220913		
Class	23-01		
1)Klaus Waren Fixtures Pvt. Ltd., 285, Paek View, 1St Floor, Flat No. 9, B.A.K Anjan Marg, Opp. Napoo Garden, Matunga (Central Railway) (E), Mumbai-400 019, Maharashtra, India.			
Date of Registration	23/01/2009		
Title	Basin Fauset		
Priority NA			
Design Number	220915		
Class	23-01		
1)Klaus Waren Fixtures Pvt. Ltd., 285, Paek View, 1St Floor, Flat No. 9, B.A.K Anjan Marg, Opp. Napoo Garden, Matunga (Central Railway) (E), Mumbai-400 019, Maharashtra, India.			
Date of Registration	23/01/2009		
Title	Spout		
Priority NA			
Design Number	221139		
Class	08-05		
1)Robert Bosch GmbH., Postfach 30 02 20, 70442 Stuttgart, Germany.			
Date of Registration	10/02/2009		
Title	Angle Grinder		
Priority			
Priority Number	Date	Country	
001013023	01/10/2008	OHIM	

Design Number	221175		
Class	23-04		
1)Crompton Greaves Limited, 6th Floor, CG House, Dr Annie Besant Road, Worli, Mumbai 400030, Maharashtra, India			
Date of Registration	12/02/2009		
Title	Pedestal Fan		
Priority NA			
Design Number	221199		
Class	15-02		
1)Weir Minerals Australia Ltd., 1 Marden Street, Artarmon, New South Wales 2064, Australia.			
Date of Registration	13/02/2009		
Title	Pump Casing Component		
Priority			
Priority Number	Date	Country	
13899/2008	14/08/2008	Australia	
Design Number	221230		
Class	05-05		
1)Charming Apparels (P) Ltd., 402-405, 1st Floor, Main Road, Chandni Chowk, Delhi-110006, India			
Date of Registration	16/02/2009		
Title	Textile Fabric		
Priority NA			

Design Number	221369		
Class	12-16		
1)Jay Ushin Ltd., GP-14, HSIDC Industrial Estate, Sector-18, Gurgaon-122 001, Haryana, India.			
Date of Registration	24/02/2009		
Title	Accessories for Vehicles		
Priority NA			
Design Number	221399		
Class	09-03		
1)Polysset Plastics Pvt. Ltd., 11-A, Mehta Industrial Estate, 1st Floor, Crossing of J. P. Road No. 2 & I.B. Road, Goregaon (E), Mumbai, Maharashtra, India.			
Date of Registration	25/02/2009		
Title	Container		
Priority NA			
Design Number	221481		
Class	23-01		
1)Hansgrohe AG., Auestr. 5-9, D-77761 Schiltach, Germany.			
Date of Registration	02/03/2009		
Title	Sanitary Faucet		
Priority			
Priority Number	Date	Country	
001007330-0003	23/09/2008	OHIM	

Design Number	221532		
Class	14-03		
1)Motorola, Inc. 1303 East Algonquin Road, Schaumburg, Illinois 60196, USA			
Date of Registration	05/03/2009		
Title	Communication Device		
Priority			
Priority Number	Date	Country	
29/324,770	19/09/2008	U.S.A.	
Design Number	221727		
Class	15-03		
1)Milltec Machinery Private Limited., No. 51-A, 1st Phase Kiadb Indl Area, Bommasandra, Bangalore-560 099, Karnataka, India.			
Date of Registration	17/03/2009		
Title	Rice Whitner		
Priority NA			
Design Number	221728		
Class	15-03		
1)Milltec Machinery Private Limited., No. 51-A, 1st Phase Kiadb Indl Area, Bommasandra, Bangalore-560 099, Karnataka, India.			
Date of Registration	17/03/2009		
Title	Rice Whitner		
Priority NA			

Design Number	221979	
Class	06-02	
1)Godrej & Boyce Mfg. Co. Ltd., Pirojshanagar, Vikhroli, Mumbai-400 079, Maharashtra, India.		
Date of Registration	26/03/2009	
Title	Hospital Bed	
Priority NA		
Design Number	221985	
Class	06-02	
1)GODREJ & BOYCE MFG. CO. LTD., PIROJSHANAGAR, VIKHROLI, MUMBAI-400 079, MAHARASHTRA, INDIA. 2)Godrej & Boyce Mfg. Co. Ltd.,		
Date of Registration	26/03/2009	
Title	Hospital Bed	
Priority NA		
Design Number	222091	
Class	05-05	
1)Charming Apparels (P) Ltd., 402-405, 1st Floor, Main Road, Chandni Chowk, Delhi-110006, India		
Date of Registration	30/03/2009	
Title	Textile Fabric	
Priority NA		

Design Number	222194	
Class	23-04	
1)Crompton Greaves Limited, 6th Floor, CG House, Dr Annie Besant Road, Worli, Mumbai 400030, Maharashtra, India		
Date of Registration	31/03/2009	
Title	Celling Fan	
Priority NA		
Design Number	222195	
Class	23-04	
1)Crompton Greaves Limited, 6th Floor, CG House, Dr Annie Besant Road, Worli, Mumbai 400030, Maharashtra, India		
Date of Registration	31/03/2009	
Title	Table Fan	
Priority NA		