

## ***CONTINUED FROM PART-1***

### **INTRODUCTION**

In view of the recent amendment made in the Designs (Amendment) Rules, 2008 with effect from 17/06/2008, Publication of the matter relating to Designs is being published in the Official Journal of The Patent Office. This Journal is being published on weekly basis on every Friday covering the various proceedings on Designs as required according to the provisions of under Rule 22, 25, 27 and 39 of the Design (Amendment) Rules, 2008. All the enquiries on this Official Journal and other information as required by the public should be addressed to the Controller General of Patents, Designs & Trade Marks. Suggestions and comments are requested from all quarters so that the content can be enriched.



THE DESIGNS ACT 2000  
SECTION 30  
DESIGN ASSIGNMENT



The Design stands in the name of MEADWEST VACO CALMAR (USA)., registered under the Designs Act, 2000 has been assigned in the Register of Design in the name as follows:-

Design No.	Class	Name
208393	09-07	<b>M/S LION HOLDINGS PVT. LTD.</b> HAVING ITS REGISTERED OFFICE AT F-2 KAILASH PLAZA : H-252 SANT NAGAR; NEW DELHI - 110 065 AND HEAD OFFICE AT C-9 KASNA ROAD; SITE - IV UPSIDC GREATER NOIDA - 201306.



## REGISTRATION OF DESIGNS

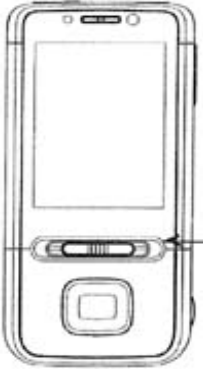

The following designs have been registered. They are now open for public inspection. In the following each entry the Date of Registration is shown. The Priority Number, Priority Date and Priority Country are also shown.

<b>Design Number</b>	206570	
<b>Class</b>	09-01	
<b>1)Black Gold Exploration Pvt. Ltd.,</b> Baroda-Jambusar N. High way Road, At & Po., Dabhasa, Ta. Padra-391440, Dist. Baroda, Gujarat, India		
<b>Date of Registration</b>	17/10/2006	
<b>Title</b>	Container	
<b>Priority NA</b>		
<b>Design Number</b>	211953	
<b>Class</b>	11-01	
<b>1)PUNITA TRRIKHA</b> S-69, GREATER KAILASH, PART-1. <b>2)Punita Trrikha</b>		
<b>Date of Registration</b>	20/08/2007	
<b>Title</b>	Ear Ring and Necklace Set	
<b>Priority NA</b>		
<b>Design Number</b>	211958	
<b>Class</b>	11-01	
<b>1)PUNITA TRRIKHA</b> S-69, GREATER KAILASH, PART-1. <b>2)Punita Trrikha</b>		
<b>Date of Registration</b>	20/08/2007	
<b>Title</b>	Necklace	
<b>Priority NA</b>		

<b>Design Number</b>	211959	
<b>Class</b>	11-01	
<b>1)PUNITA TRRIKHA</b> S-69, GREATER KAILASH, PART-1. <b>2)Punita Trrikha</b>		
<b>Date of Registration</b>	20/08/2007	
<b>Title</b>	Necklace	
<b>Priority NA</b>		
<b>Design Number</b>	211960	
<b>Class</b>	11-01	
<b>1)PUNITA TRRIKHA</b> S-69, GREATER KAILASH, PART-1. <b>2)Punita Trrikha</b>		
<b>Date of Registration</b>	20/08/2007	
<b>Title</b>	Necklace	
<b>Priority NA</b>		
<b>Design Number</b>	211965	
<b>Class</b>	11-01	
<b>1)PUNITA TRRIKHA</b> S-69, GREATER KAILASH, PART-1. <b>2)Punita Trrikha</b>		
<b>Date of Registration</b>	20/08/2007	
<b>Title</b>	Pendant	
<b>Priority NA</b>		

<b>Design Number</b>	211969		
<b>Class</b>	11-01		
<b>1)PUNITA TRRIKHA</b> S-69, GREATER KAILASH, PART-1, NEW DELHI-110048 <b>2)Punita Trrikha</b>			
<b>Date of Registration</b>	20/08/2007		
<b>Title</b>	Necklace		
<b>Priority NA</b>			
<b>Design Number</b>	211970		
<b>Class</b>	11-01		
<b>1)PUNITA TRRIKHA</b> S-69, GREATER KAILASH, PART-1. <b>2)Punita Trrikha</b>			
<b>Date of Registration</b>	20/08/2007		
<b>Title</b>	Necklace		
<b>Priority NA</b>			
<b>Design Number</b>	213872		
<b>Class</b>	14-03		
<b>1)Nokia Corporation.,</b> Keilalahdentie 4, Fin-02150 Espoo, Finland.			
<b>Date of Registration</b>	20/12/2007		
<b>Title</b>	Button for a Handset		
<b>Priority</b>			
<b>Priority Number</b>	<b>Date</b>	<b>Country</b>	
M20070121	20/06/2007	Finland	

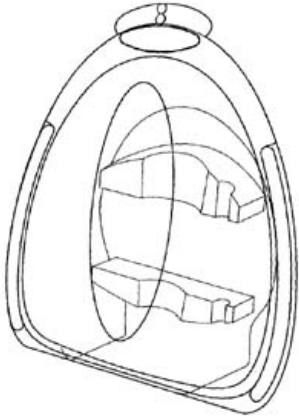
<b>Design Number</b>	215706		
<b>Class</b>	08-09		
<b>1)Shilpa Metal Industries.,</b> B-5, Friends Industrial Estate, Sherpur Chowk, Near Arti Steels, Ludhiana-141 010, Punjab, India.			
<b>Date of Registration</b>	03/04/2008		
<b>Title</b>	Hook		
<b>Priority NA</b>			
<b>Design Number</b>	216002		
<b>Class</b>	24-99		
<b>1)A.S.ASHISH.,</b> 11/159, ANJANA, CHERUVANNUR, KOLATHARA POST, PIN-673655, KOZHIKODE DISTRICT, KERALA, INDIA. <b>2)A. S. Ashish</b>			
<b>Date of Registration</b>	24/04/2008		
<b>Title</b>	Device for the Disposal of Used Sanitary Pads and Small Medical Dressings		
<b>Priority NA</b>			
<b>Design Number</b>	216454		
<b>Class</b>	13-99		
<b>1)Clipsal Australia Pty Ltd.,</b> 12 Park Terrace, Bowden, 5007 South Australia, Australia.			
<b>Date of Registration</b>	27/05/2008		
<b>Title</b>	Cable Rack Cover		
<b>Priority</b>			
Priority Number	Date	Country	
21053/2007	29/11/2007	Australia	

<b>Design Number</b>	216823		
<b>Class</b>	09-03		
<b>1)Reckitt Benckiser (UK) Limited.</b> 103-105 Bath Road, Slough, Berkshire, SL1 3UH, UK.			
<b>Date of Registration</b>	20/06/2008		
<b>Title</b>	Packaging of Cosmetic Products		
<b>Priority</b>			
Priority Number	Date	Country	
000846902-0002	20/12/2007	OHIM	
<b>Design Number</b>	216981		
<b>Class</b>	10-04		
<b>1)Chatsworth Products, Inc.,</b> 31425 Agoura Road Westlake Village, CA 91361-4614, USA			
<b>Date of Registration</b>	02/07/2008		
<b>Title</b>	Raceway for Cable Management		
<b>Priority</b>			
Priority Number	Date	Country	
29/299,948	07/01/2008	U.S.A.	
<b>Design Number</b>	216985		
<b>Class</b>	10-04		
<b>1)Chatsworth Products, Inc.,</b> 31425 Agoura Road Westlake Village, CA 91361-4614, United States of America			
<b>Date of Registration</b>	02/07/2008		
<b>Title</b>	Raceway for Cable Management		
<b>Priority</b>			
Priority Number	Date	Country	
29/302,236	14/01/2008	U.S.A.	

<b>Design Number</b>	217721	
<b>Class</b>	23-01	
<b>1)Kohler Co.,</b> 444 Highland drive, Kohler, Wisconsin 53044, USA		
<b>Date of Registration</b>	12/08/2008	
<b>Title</b>	Faucet Body	
<b>Priority</b>		
Priority Number	Date	Country
29/303,599	12/02/2008	U.S.A.

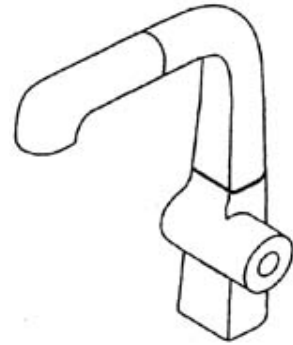

<b>Design Number</b>	218379	
<b>Class</b>	23-01	
<b>1)Tata Chemicals Ltd.,</b> Bombay House, 24 Homi Modi Street, Mumbai 400001, India		
<b>Date of Registration</b>	05/09/2008	
<b>Title</b>	Holder for Water Filter	
<b>Priority NA</b>		







<b>Design Number</b>	218659	
<b>Class</b>	23-01	
<b>1)McAlpine &amp; Company Limited</b> Kelvin Avenue, Hillington, Glasgow, G52 4LF, UK		
<b>Date of Registration</b>	17/09/2008	
<b>Title</b>	Plumbing Fixture	
<b>Priority</b>		
Priority Number	Date	Country
000899166-0004	18/03/2008	OHIM







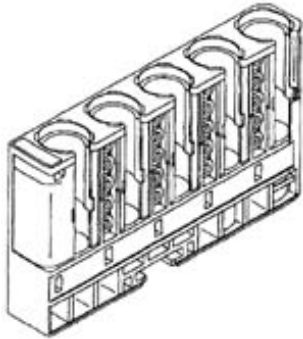



<b>Design Number</b>	218935		
<b>Class</b>	13-03		
<b>1)Metallizing Equipment Co. Private Limited</b> E-101, M.I.A., Phase-II, Basni, Jodhpur-342 005, Rajasthan, India			
<b>Date of Registration</b>	01/10/2008		
<b>Title</b>	Power Source for ARC Spray		
<b>Priority NA</b>			
<b>Design Number</b>	219333		
<b>Class</b>	21-02		
<b>1)Sharma Exports</b> B-16, Sports & Surgical Complex, Kapurthala Road, Jalandhar-144021, Punjab, India			
<b>Date of Registration</b>	20/10/2008		
<b>Title</b>	Ball (Toy)		
<b>Priority NA</b>			
<b>Design Number</b>	219400		
<b>Class</b>	23-04		
<b>1)ebm-papst Mulfingen GmbH &amp; Co., KG</b> Bachmuhle 2, 74673 Mulfingen, Germany			
<b>Date of Registration</b>	22/10/2008		
<b>Title</b>	Fan		
<b>Priority</b>			
Priority Number	Date	Country	
000928247	02/05/2008	OHIM	

<b>Design Number</b>	219447	
<b>Class</b>	11-01	
<b>1) Sayani Metal Works,</b> 13, Shripal Service Industrial Estate, Near Pawan Baug, Chincholi Phatak "x" Road, Malad (w), Mumbai, India		
<b>Date of Registration</b>	27/10/2008	
<b>Title</b>	Ear Ring Set	
<b>Priority NA</b>		
<b>Design Number</b>	219458	
<b>Class</b>	10-04	
<b>1) Freemans Measures Limited</b> G. T. Road, Jugiana, Ludhiana-141120, Punjab, India		
<b>Date of Registration</b>	27/10/2008	
<b>Title</b>	Measuring Tape	
<b>Priority NA</b>		
<b>Design Number</b>	219507	
<b>Class</b>	26-06	
<b>1) Minda Industries Ltd.,</b> Lighting Division, 34-35, K. M. G T Road, Village Rasoi, Sonapat, Haryana, India		
<b>Date of Registration</b>	03/11/2008	
<b>Title</b>	High Mount Stop Lamp	
<b>Priority NA</b>		

<b>Design Number</b>	219518		
<b>Class</b>	24-01		
<b>1)Hitachi High-Technologies Corporation</b> 1-24-14, Nishi Shinbashi, Minato-Ku, Tokyo, Japan			
<b>Date of Registration</b>	31/10/2008		
<b>Title</b>	Sample Rack		
<b>Priority</b>			
Priority Number	Date	Country	
2008-018583	18/07/2008	Japan	
<b>Design Number</b>	219549		
<b>Class</b>	07-07		
<b>1)M/s. IE - Tech Metalware India Private Limited</b> #21-H, Sidco Industrial Estate, Ambattur, Chennai-600 098, Tamil Nadu, India			
<b>Date of Registration</b>	05/11/2008		
<b>Title</b>	Hot Pot		
<b>Priority NA</b>			
<b>Design Number</b>	219565		
<b>Class</b>	08-06		
<b>1)Kishan Kumar Gupta</b> N-1, Chittaranjan Park, Delhi-110019, India			
<b>Date of Registration</b>	06/11/2008		
<b>Title</b>	Door Handle		
<b>Priority NA</b>			

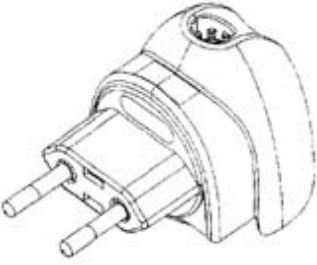

<b>Design Number</b>	219739	
<b>Class</b>	13-01	
<b>1)Rotomag Morots &amp; Controls Pvt. Ltd.,</b> 7/C, Vitthal Udyognagar, Nr. Anand- 388121, Gujarat, India		
<b>Date of Registration</b>	18/11/2008	
<b>Title</b>	Motor for Air Conditioning	
<b>Priority NA</b>		
<b>Design Number</b>	219741	
<b>Class</b>	13-01	
<b>1)Rotomag Morots &amp; Controls Pvt. Ltd.,</b> 7/C, Vitthal Udyognagar, Nr. Anand- 388121, Gujarat, India		
<b>Date of Registration</b>	18/11/2008	
<b>Title</b>	Motor	
<b>Priority NA</b>		
<b>Design Number</b>	219762	
<b>Class</b>	19-06	
<b>1)ADD Corporation Limited</b> Business Park, 6th Floor, Chincholi Naka, S. V. Road, Malad (West), Mumbai-400064, Maharashtra, India		
<b>Date of Registration</b>	19/11/2008	
<b>Title</b>	Writing Instrument	
<b>Priority NA</b>		

<b>Design Number</b>	219763		
<b>Class</b>	19-06		
<b>1)ADD Corporation Limited</b> Business Park, 6th Floor, Chincholi Naka, S. V. Road, Malad (West), Mumbai-400064, Maharashtra, India			
<b>Date of Registration</b>	19/11/2008		
<b>Title</b>	Writing Instrument		
<b>Priority NA</b>			
<b>Design Number</b>	219888		
<b>Class</b>	14-03		
<b>1)Nokia Corporation</b> Keilalahdentie 4 Fin-02150, Espoo, Finland			
<b>Date of Registration</b>	27/11/2008		
<b>Title</b>	Handset		
<b>Priority</b>			
Priority Number	Date	Country	
29/319,007	02/06/2008	U.S.A.	
<b>Design Number</b>	219963		
<b>Class</b>	14-03		
<b>1)Nokia Corporation.,</b> Keilalahdentie 4, Fin-02150 Espoo, Finland.			
<b>Date of Registration</b>	01/12/2008		
<b>Title</b>	Handset Front Cover		
<b>Priority</b>			
Priority Number	Date	Country	
29/320,931	08/07/2008	U.S.A.	

<b>Design Number</b>	220000		
<b>Class</b>	23-04		
<b>1)Zobebe Holding SPA</b> Via Fersina, 4, 38100 Trento, Italy			
<b>Date of Registration</b>	04/12/2008		
<b>Title</b>	Diffusing Evaporators		
<b>Priority</b>			
Priority Number	Date	Country	
000963798	03/07/2008	OHIM	

<b>Design Number</b>	220037		
<b>Class</b>	06-06		
<b>1)Hardware Concepts India Private Limited</b> 101 Laxmi Narayan Chs., Plot No.-353, S. K. Bole Road, Dadar (W), Mumbai-400028, Maharashtra, India			
<b>Date of Registration</b>	08/12/2008		
<b>Title</b>	Profile Used in Furniture Fitting		
<b>Priority NA</b>			



<b>Design Number</b>	220150		
<b>Class</b>	09-01		
<b>1)Paras Pharmaceuticals Limited</b> Paras House, 6/B, Sattar Taluka Society, Nr. Navjeevan P.O., Ahmedabad-380 014, Gujarat, India			
<b>Date of Registration</b>	11/12/2008		
<b>Title</b>	Container		
<b>Priority NA</b>			

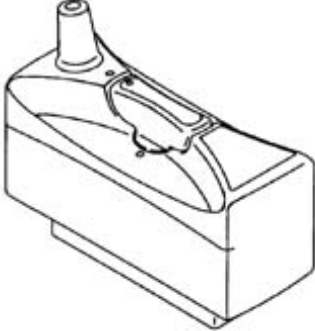
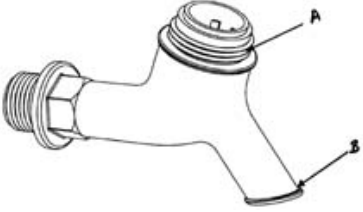

<b>Design Number</b>	220289	
<b>Class</b>	06-05	
<b>1)Godrej &amp; Boyce Mfg. Co. Ltd., Pirojshanagar, Vikhroli, Mumbai-400 079, Maharashtra, India.</b>		
<b>Date of Registration</b>	17/12/2008	
<b>Title</b>	Desk-Chair Combination	
<b>Priority NA</b>		
<b>Design Number</b>	220369	
<b>Class</b>	21-02	
<b>1)EM CEE CEE Sports Agencies (P) Ltd., Jonex House, Sodal Road, Jalandhar-144 004, Punjab, India</b>		
<b>Date of Registration</b>	22/12/2008	
<b>Title</b>	Wheel For Roller Skate	
<b>Priority NA</b>		
<b>Design Number</b>	220510	
<b>Class</b>	13-03	
<b>1)Acme Tele Power Ltd., DLF Infinity Buildings, Tower C, 9th Floor, DLF Cyber City, Phase II, Gurgaon-122002, Haryana</b>		
<b>Date of Registration</b>	26/12/2008	
<b>Title</b>	Split Power Interface Unit	
<b>Priority NA</b>		

<b>Design Number</b>	220606	
<b>Class</b>	07-04	
<b>1)MA Design India Private Limited</b> C-26, Sector, 63, Noida-201301, U.P., India		
<b>Date of Registration</b>	31/12/2008	
<b>Title</b>	Cutting Board	
<b>Priority NA</b>		
<b>Design Number</b>	220656	
<b>Class</b>	19-06	
<b>1)JAYESH GOVIND BHAI HINGRAJIYA.,</b> MAHADEVWADI MAIN ROAD, B/H BHAKTINAZAR STATION, SNOW ICE FACTORY ROAD, RAJKOT-360 005, GUJARAT, INDIA. <b>2)M/s Shyari Metals</b>		
<b>Date of Registration</b>	05/01/2009	
<b>Title</b>	Compass	
<b>Priority NA</b>		
<b>Design Number</b>	220672	
<b>Class</b>	07-02	
<b>1)JYOTI PRAKASH BRAHMAWAR.,</b> 28, KRISHNA BHANDARI COMPOUND, 90 FEET ROAD, GANESH NAGAR, CHARKOP, KANDIVALI (W) MUMBAI-400 067, MAHARASHTRA, INDIA. <b>2)Shree Balaji Appliances</b>		
<b>Date of Registration</b>	06/01/2009	
<b>Title</b>	Cooking Appliances	
<b>Priority NA</b>		

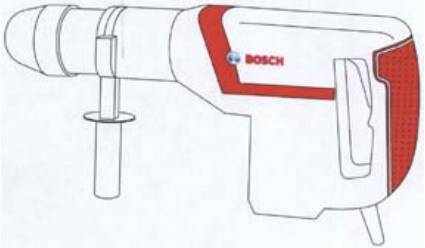



<b>Design Number</b>	220742		
<b>Class</b>	12-16		
<b>1)JAI NARAIN.,</b> WZ-486, KAILASH PURI, PALAM COLONY, NEW DELHI, INDIA. <b>2)Jai Narain.,</b>			
<b>Date of Registration</b>	12/01/2009		
<b>Title</b>	Wheel Cover		
<b>Priority NA</b>			
<b>Design Number</b>	220758		
<b>Class</b>	24-01		
<b>1)Hitachi Medical Corporation.,</b> 14-1, Sotokanda 4-Chome, Chiyoda-Ku, Tokyo, Japan.			
<b>Date of Registration</b>	13/01/2009		
<b>Title</b>	Ultrasonic Probe Connector		
<b>Priority</b>			
Priority Number	Date	Country	
2008-018454	17/07/2008	Japan	
<b>Design Number</b>	220772		
<b>Class</b>	23-01		
<b>1)Watertec (Malaysia) Sdn Bhd.,</b> Lot 6 Jalan Halba 16/16, Section 16, 40200 Shah Alam, Selangor, Malaysia.			
<b>Date of Registration</b>	14/01/2009		
<b>Title</b>	Tap		
<b>Priority NA</b>			

<b>Design Number</b>	221140		
<b>Class</b>	08-05		
<b>1)Robert Bosch GmbH.,</b> Postfach 30 02 20, 70442 Stuttgart, Germany.			
<b>Date of Registration</b>	10/02/2009		
<b>Title</b>	Power Hammer		
<b>Priority</b>			
Priority Number	Date	Country	
001013023	01/10/2008	OHIM	
<b>Design Number</b>	221161		
<b>Class</b>	23-02		
<b>1)Hindustan Sanitaryware &amp; Industries Limited.,</b> Bahadurgarh-124507, Dist. Jhajjar, Haryana, India.			
<b>Date of Registration</b>	12/02/2009		
<b>Title</b>	Cistern		
<b>Priority NA</b>			
<b>Design Number</b>	221163		
<b>Class</b>	23-02		
<b>1)Hindustan Sanitaryware &amp; Industries Limited.,</b> Bahadurgarh-124507, Dist. Jhajjar, Haryana, India.			
<b>Date of Registration</b>	12/02/2009		
<b>Title</b>	Cistern		
<b>Priority NA</b>			

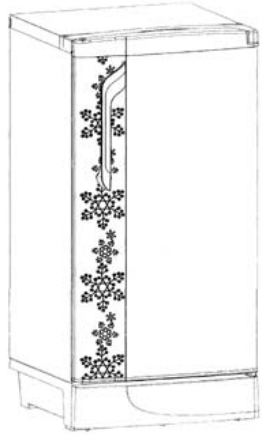
<b>Design Number</b>	221165	
<b>Class</b>	23-02	
<b>1)Hindustan Sanitaryware &amp; Industries Limited., Bahadurgarh-124507, Dist. Jhajjar, Haryana, India.</b>		
<b>Date of Registration</b>	12/02/2009	
<b>Title</b>	Toilet Seat	
<b>Priority NA</b>		
<b>Design Number</b>	221204	
<b>Class</b>	15-02	
<b>1)S. S. Products of India., V. &amp; P. O. Gill, Malerkotla-Road, Ludhiana-141 006, Punjab, India.</b>		
<b>Date of Registration</b>	13/02/2009	
<b>Title</b>	Air Pump	
<b>Priority NA</b>		
<b>Design Number</b>	221241	
<b>Class</b>	23-02	
<b>1)Hindustan Sanitaryware &amp; Industries Limited., Bahadurgarh-124507, Dist. Jhajjar, Haryana, India.</b>		
<b>Date of Registration</b>	16/02/2009	
<b>Title</b>	Toilet Seat	
<b>Priority NA</b>		

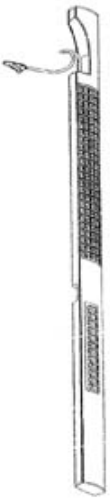
<b>Design Number</b>	221325	
<b>Class</b>	15-07	
<b>1)Godrej &amp; Boyce Mfg. Co. Ltd.,</b> Pirojshanagar, Vikhroli, Mumbai-400 079, Maharashtra, India.		
<b>Date of Registration</b>	19/02/2009	
<b>Title</b>	Refrigerator	
<b>Priority NA</b>		

<b>Design Number</b>	221518	
<b>Class</b>	17-01	
<b>1)Eigenlabs Limited.,</b> 5th Floor, Walmar House, 288 Regent Street, London W1B 3AL, UK		
<b>Date of Registration</b>	04/03/2009	
<b>Title</b>	Electronic Musical Instrument	
<b>Priority</b>		
Priority Number	Date	Country
001004626	12/09/2008	OHIM

<b>Design Number</b>	221633	
<b>Class</b>	06-08	
<b>1)Peter Freislederer</b> 103, Garden View, Dadabhai Road, Off J.P.Road, Andheri (West), Mumbai-400 058, Maharashtra, India.		
<b>Date of Registration</b>	13/03/2009	
<b>Title</b>	Hanger	
<b>Priority NA</b>		

<b>Design Number</b>	221986	
<b>Class</b>	06-04	
<b>1)Godrej &amp; Boyce Mfg. Co. Ltd.,</b> Pirojshanagar, Vikhroli, Mumbai-400 079, Maharashtra, India.		
<b>Date of Registration</b>	26/03/2009	
<b>Title</b>	Bed Side Locker	
<b>Priority NA</b>		