

CONTINUED FROM PART-1

INTRODUCTION

In view of the recent amendment made in the Designs (Amendment) Rules, 2008 with effect from 17/06/2008, Publication of the matter relating to Designs is being published in the Official Journal of The Patent Office. This Journal is being published on weekly basis on every Friday covering the various proceedings on Designs as required according to the provisions of under Rule 22, 25, 27 and 39 of the Design (Amendment) Rules, 2008. All the enquiries on this Official Journal and other information as required by the public should be addressed to the Controller General of Patents, Designs & Trade Marks. Suggestions and comments are requested from all quarters so that the content can be enriched.

CANCELLATION PROCEEDINGS
under Section 19(1) of the Designs Act, 2000 &
Designs (Amendment) Rules, 2008



“J.P. Distilleries Pvt. Ltd., an Indian company registered under the Companies Act, 1956 of 190, Sankey Road, Sadashivanagar, Bangalore – 560080 filed an application on 2/12/2009 for cancellation of registration of registered Design No. 214542 under class 09-01 titled as ‘Bottle’ in the name of John Distilleries Ltd.”

“Aftabuddin of M/s. Royal Plastics, 7264, Old Rohtak Road, Azad Market, Delhi-110006 filed an application on 5/1/2010 for cancellation of registration of registered Design No. 217288 under class 07-02 titled as ‘Casserole’ in the name of Nayasa Homeware.”

“Ronak Engineering, a partnership firm consisting partners Shri V.L. Tilada and Shri S.N. Sakhiya having principal place of business at 13-Galaxy Industrial Estate, Survey No.275, Near Gravety Casting, Shapar (Veraval), Dist. Rajkot (Gujarat), India filed an application on 21/1/2010 for cancellation of registration of registered Design No. 220498 under class 15-09 titled as ‘Briquetting Plant Machine’ in the name of Sanjay Ratilal Tilala.”

REGISTRATION OF DESIGNS

The following designs have been registered. They are now open for public inspection. In the following each entry the Date of Registration is shown. The Priority Number, Priority Date and Priority Country are also shown.

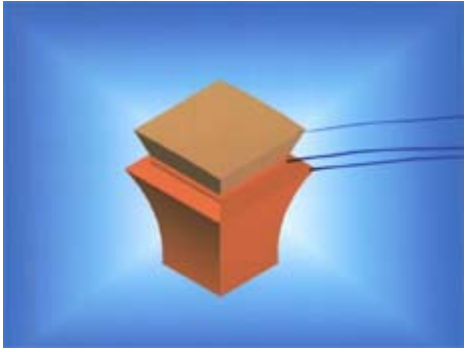

Design Number	206513	
Class	09-03	
1)Perfunova International Limited 413, B-Wing, Trade World, Kamala Mills Compounds, Senapati Bapat Marg, Lower Parel (W), Mumbai-400013, Maharashtra, India		
Date of Registration	30/08/2006	
Title	Container	
Priority NA		
Design Number	206514	
Class	19-02	
1)Perfunova International Limited 413, B-Wing, Trade World, Kamala Mills Compound, Senapati Bapat Marg, Lower Parel (W), Mumba400013, Maharashtra, India		
Date of Registration	30/08/2006	
Title	Container	
Priority NA		
Design Number	206515	
Class	09-01	
1)Perfunova International Limited 413, B-Wing, Trade World, Kamala Mills Compounds, Senapati Bapat Marg, Lower Parel (W), Mumbai-400013, Maharashtra, India		
Date of Registration	30/08/2006	
Title	Bottle	
Priority NA		

Design Number	206566	
Class	09-01	
1)French Cosmetics Pvt. Ltd., Baroda-Jambusar N. High Way Road, At & Po. Dabhasa Ta. Padra-391440, Dist. Baroda, Gujarat, India		
Date of Registration	17/10/2006	
Title	Container	
Priority NA		

Design Number	207366	
Class	03-01	
1)Valigeria Roncato SPA Via Pioga, 91 35011 Campodarsego(PD), Italy		
Date of Registration	08/12/2006	
Title	Luggage Bag	
Priority NA		

Design Number	207367	
Class	03-01	
1)Valigeria Roncato SPA Via Pioga, 91 35011 Campodarsego(PD), Italy		
Date of Registration	08/12/2006	
Title	Luggage Bag	
Priority NA		



Design Number	207368	
Class	03-01	
1)Valigeria Roncato SPA Via Pioga, 91 35011 Campodarsego(PD), Italy		
Date of Registration	08/12/2006	
Title	Luggage Bag	
Priority NA		
Design Number	207369	
Class	03-01	
1)Valigeria Roncato SPA Via Pioga, 91 35011 Campodarsego(PD), Italy		
Date of Registration	08/12/2006	
Title	Luggage Bag	
Priority NA		
Design Number	207370	
Class	03-01	
1)Valigeria Roncato SPA Via Pioga, 91 35011 Campodarsego(PD), Italy		
Date of Registration	08/12/2006	
Title	Luggage Bag	
Priority NA		



Design Number	207373		
Class	03-01		
1)Valigeria Roncato SPA Via Pioga, 91 35011 Campodarsego(PD), Italy			
Date of Registration	08/12/2006		
Title	Luggage Bag		
Priority NA			
Design Number	207374		
Class	03-01		
1)Valigeria Roncato SPA Via Pioga, 91 35011 Campodarsego(PD), Italy			
Date of Registration	08/12/2006		
Title	Luggage Bag		
Priority NA			
Design Number	207405		
Class	13-03		
1)Legrand France 128 Avenue Du Marechal De Lattre-De-Tassigny Fr-87000 Limoges, France 2)Legrand Snc			
Date of Registration	12/06/2006		
Title	Electrical Box		
Priority			
Priority Number	Date	Country	
000545603	12/06/2006	OHIM	



Design Number	208088		
Class	02-04		
1)Ajay Polymers L-5, Udyog Nagar, Delhi-110041, India			
Date of Registration	29/01/2007		
Title	Footwear		
Priority NA			
Design Number	213069		
Class	04-02		
1)PULFREY, SHAUN., FLAT 93, ARLINGTON LODGE, BRIXTON HILL, LONDON, SW2 1RF, UK. 2)Pulfrey, Shaun.,			
Date of Registration	26/10/2007		
Title	Hair Brush		
Priority			
Priority Number	Date	Country	
000717533	27/04/2007	OHIM	
Design Number	213072		
Class	26-05		
1)Led Lighting Fixtures, Inc., 617 Davis Drive, Suite 200, Keystone Technology, Park VI, Morrisville, NC 27560, USA			
Date of Registration	26/10/2007		
Title	Lighting Device		
Priority			
Priority Number	Date	Country	
29/279,352	27/04/2007	U.S.A.	

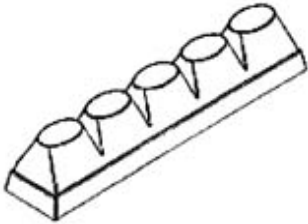

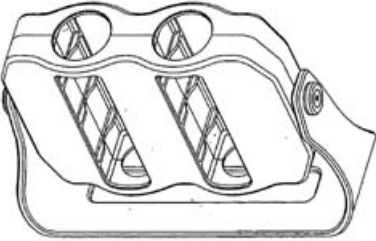
Design Number	213073		
Class	26-05		
1)Led Lighting Fixtures, Inc., 617 Davis Drive, Suite 200, Keystone Technology, Park VI, Morrisville, NC 27560, USA			
Date of Registration	26/10/2007		
Title	Lighting Device		
Priority			
Priority Number	Date	Country	
29/279,354	27/04/2007	U.S.A.	
Design Number	213635		
Class	23-01		
1)Pricol Limited., P.B.No. 6331, (1087-A), New No. 702/7, Avanashi Road, Coimbatore- 641 037, TN, India.			
Date of Registration	04/12/2007		
Title	A Float Guide for Fluid		
Priority NA			
Design Number	214208		
Class	23-04		
1)Crompton Greaves Limited 6th Floor, CG House, Dr Annie Besant Road, Worly, Mumbai-400030, Maharashtra, India			
Date of Registration	11/01/2008		
Title	Ceiling Fan		
Priority NA			



Design Number	214552	
Class	23-01	
1)Toyox Co., Ltd., 4371, Maezawa, Kurobe-Shi, Toyama-Ken, Japan.		
Date of Registration	05/02/2008	
Title	Hose	
Priority NA		
Design Number	214559	
Class	23-01	
1)Toyox Co., Ltd., 4371, Maezawa, Kurobe-Shi, Toyama-Ken, Japan.		
Date of Registration	05/02/2008	
Title	Hose	
Priority NA		
Design Number	214752	
Class	22-05	
1)RICHARD W.O.SYLVESTER., BLOCK-N, NO. 227, 27TH STREET, ANNANAGAR EAST, CHENNAI-600 102, TN, INDIA. 2)Richard W.O.Sylvester.,		
Date of Registration	15/02/2008	
Title	Fishing Gaff	
Priority NA		

Design Number	214957	
Class	27-06	
1)GTC Industries Ltd Tobacco House, S.V.Road, Vile Parle (W), Mumbai-400056, Maharashtra, India		
Date of Registration	28/02/2008	
Title	Cigarette Cases	
Priority NA		
Design Number	215086	
Class	07-01	
1)Eicher Goodearth Limited., Eicher House, 12 Commercial Complex, Greater Kailash-II (Masjid Moth), New Delhi-110048, India		
Date of Registration	03/03/2008	
Title	Bowl	
Priority NA		
Design Number	215109	
Class	01-01	
1)Société Des Produits Nestlé S.A., 1800 Vevey, Canton of Vaud, Switzerland.		
Date of Registration	04/03/2008	
Title	Wafer Bar	
Priority NA		



Design Number	215252		
Class	06-04		
1)Invitrogen Dynal AS Ullernchausseen 52, N-0379 Oslo, Norway			
Date of Registration	12/03/2008		
Title	Magnetic Separation Rack		
Priority			
Priority Number	Date	Country	
000788799-0001	12/09/2007	OHIM	
Design Number	216355		
Class	08-06		
1)Orchid Hardware (P) Ltd., 143/A II AJI, GIDC, Rajkot-360 003, Gujarat, India.			
Date of Registration	16/05/2008		
Title	Door Handle		
Priority NA			
Design Number	216580		
Class	04-02		
1)JHS Svendgaard Laboratories Limited., B-1/E-23, Mohan Co-Operative Industrial Area, Mathura Road, New Delhi-110 044, India.			
Date of Registration	10/06/2008		
Title	Toothbrush		
Priority NA			

Design Number	216581	
Class	04-02	
1)JHS Svendgaard Laboratories Limited., B-1/E-23, Mohan Co-Operative Industrial Area, Mathura Road, New Delhi-110 044, India.		
Date of Registration	10/06/2008	
Title	Toothbrush	
Priority NA		
Design Number	216582	
Class	04-02	
1)JHS Svendgaard Laboratories Limited., B-1/E-23, Mohan Co-Operative Industrial Area, Mathura Road, New Delhi-110 044, India.		
Date of Registration	10/06/2008	
Title	Toothbrush	
Priority NA		
Design Number	216583	
Class	04-02	
1)JHS Svendgaard Laboratories Limited., B-1/E-23, Mohan Co-Operative Industrial Area, Mathura Road, New Delhi-110 044, India.		
Date of Registration	10/06/2008	
Title	Toothbrush	
Priority NA		

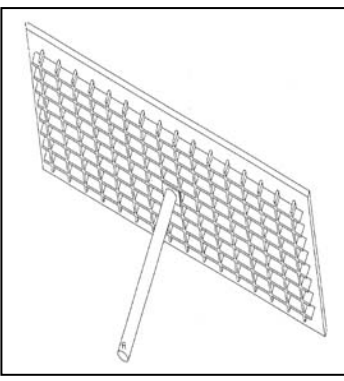
Design Number	216584	
Class	04-02	
1)JHS Svendgaard Laboratories Limited., B-1/E-23, Mohan Co-Operative Industrial Area, Mathura Road, New Delhi-110 044, India.		
Date of Registration	10/06/2008	
Title	Toothbrush	
Priority NA		
Design Number	216586	
Class	04-02	
1)JHS Svendgaard Laboratories Limited., B-1/E-23, Mohan Co-Operative Industrial Area, Mathura Road, New Delhi-110 044, India.		
Date of Registration	10/06/2008	
Title	Toothbrush	
Priority NA		
Design Number	217203	
Class	19-06	
1)Camlin Limited., Hilton House, 48/2, Central Road, Midc, Opp. Tunga Paradise Hotel, Andheri (East), Mumabi-400 093, Maharashtra, India.		
Date of Registration	17/07/2008	
Title	Marker Pen	
Priority NA		

Design Number	217227		
Class	25-04		
1)DAVINDER BHASIN., C-128, PHASE-V, FOCAL POINT, LUDHIANA-141 010, PUNJAB, INDIA. 2)Davinder Bhasin.,			
Date of Registration	21/07/2008		
Title	Stair Tower		
Priority NA			
Design Number	217350		
Class	19-06		
1)Elkos Pens Limited 575, Rabindra Sarani, Bagbazar, Kolkata-700003, West Bengal, India			
Date of Registration	24/07/2008		
Title	Pen		
Priority NA			
Design Number	217787		
Class	20-02		
1)Visplay International AG Klunefeldstrasse 22, CH-4132 Muttenz, Switzerland			
Date of Registration	14/08/2008		
Title	Display Rack		
Priority			
Priority Number	Date	Country	
134 868	14/02/2008	Switzerland	

Design Number	217983	
Class	06-01	
1)Superflow Private Limited 198/48, Ramesh Nagar (Garhi), East of Kailash, Near Sapna Cinema, New Delhi, 110 065, India		
Date of Registration	21/08/2008	
Title	Seat Cover	
Priority NA		
Design Number	218290	
Class	07-01	
1)Ravissant Pvt. Ltd. 50-51, Commercial Complex, New Friends Colony, New Delhi-110065. India		
Date of Registration	01/09/2008	
Title	Serving Bowl	
Priority NA		
Design Number	218293	
Class	26-02	
1)Ravissant Pvt. Ltd. 50-51, Commercial Complex, New Friends Colony, New Delhi- 110065. India		
Date of Registration	01/09/2008	
Title	OIL LAMP AND INCENSE STICK STAND(SET)	
Priority NA		

Design Number	218631		
Class	09-01		
1)Mahika Packaging (India) Ltd., 2/3, Kasturba Talkies Compound, Station Road, Malad (West), Mumbai-400064			
Date of Registration	18/09/2008		
Title	Bottle		
Priority NA			
Design Number	218937		
Class	08-01		
1)Seco Tools AB S-737 82 Fagersta, Sweden			
Date of Registration	01/10/2008		
Title	Drilling Tools		
Priority			
Priority Number	Date	Country	
000917489	14/04/2008	Sweden	
Design Number	219304		
Class	26-04		
1)Panasonic Corporation 1006, Oaza Kadoma, Kadoma-Shi, Osaka 571-8501, Japan			
Date of Registration	20/10/2008		
Title	Light Emitting Diode Lamp		
Priority NA			

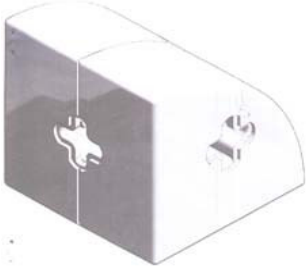

Design Number	219357	
Class	09-03	
1)Arihant Plast K-57, Sonal Heavy Ind., Estate. Kachpada, Malad (W), Mumbai-400064, Maharashtra, India		
Date of Registration	21/10/2008	
Title	Container	
Priority NA		
Design Number	219358	
Class	09-03	
1)Arihant Plast K-57, Sonal Heavy Ind., Estate. Kachpada, Malad (W), Mumbai-400064, Maharashtra, India		
Date of Registration	21/10/2008	
Title	Container	
Priority NA		
Design Number	219379	
Class	06-01	
1)Nilkamal Limited Survey No.-354/2 & 354/3, Near Rakholi Bridge, Silvassa, Khanvel Road, Village Vasona, Silvassa (D & N. H.), U. T., India		
Date of Registration	21/10/2008	
Title	Chair	
Priority NA		

Design Number	219397		
Class	23-04		
1)ebm-papst Mulfingen Gmbh & Co., KG Bachmuhle 2, 74673 Mulfingen, Germany			
Date of Registration	22/10/2008		
Title	Fans		
Priority			
Priority Number	Date	Country	
000928247	02/05/2008	OHIM	
Design Number	219403		
Class	23-04		
1)ebm-papst Mulfingen Gmbh & Co., KG Bachmuhle 2, 74673 Mulfingen, Germany			
Date of Registration	22/10/2008		
Title	Fan		
Priority			
Priority Number	Date	Country	
000928247	02/05/2008	OHIM	
Design Number	219470		
Class	26-03		
1)Crompton Greaves Limited 6th Floor, CG House, Dr Annie Besant Road, Worly, Mumbai-400030, Maharashtra, India			
Date of Registration	29/10/2008		
Title	Bollard		
Priority NA			

Design Number	219500		
Class	21-01		
1)3L-Rask APS Vibaekvej 100, Brylle, 5690 Tommerup, Denmark			
Date of Registration	31/10/2008		
Title	Building Bricks		
Priority			
Priority Number	Date	Country	
000927850-0003	02/05/2008	OHIM	

Design Number	219687		
Class	09-08		
1)Nilkamal Limited Survey No.-354/2 & 354/3, Near Rakholi Bridge, Silvassa, Khanvel Road, Village Vasona, Silvassa (D & N. H.), U. T., India			
Date of Registration	14/11/2008		
Title	Pallet		
Priority NA			

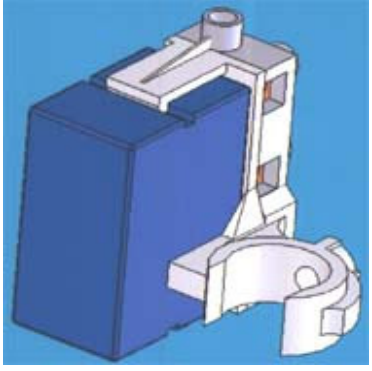
Design Number	219735		
Class	06-01		
1)Nilkamal Limited Survey No.-354/2 & 354/3, Near Rakholi Bridge, Silvassa, Khanvel Road, Village Vasona, Silvassa (D & N. H.), U. T., India			
Date of Registration	18/11/2008		
Title	Chair		
Priority NA			

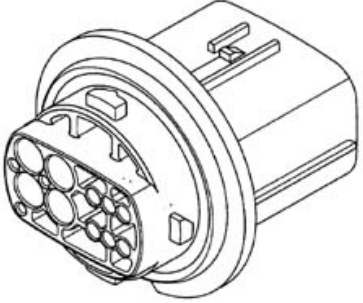
Design Number	219745		
Class	13-99		
1)Crompton Greaves Limited 6th Floor, CG House, Dr Annie Besant Road, Worly, Mumbai-400030, Maharashtra, India			
Date of Registration	18/11/2008		
Title	Terminal Block for Fan		
Priority NA			
Design Number	219779		
Class	15-09		
1)Amber Enterprises India (P) Ltd., C-1, Phase-II, Focal Point, Rajpura-140401, Punjab, India			
Date of Registration	20/11/2008		
Title	Turret Punching Press		
Priority NA			
Design Number	219788		
Class	26-99		
1)Sumitomo Wiring Systems, Ltd., 1-14, Nishisuehiro-cho, Yokkaichi-shi, Mie-Ken 510-8503, Japan			
Date of Registration	21/11/2008		
Title	Light Bulb Socket		
Priority			
Priority Number	Date	Country	
2008-013041	23/05/2008	Japan	

Design Number	219789	
Class	26-99	
1)Sumitomo Wiring Systems, Ltd., 1-14, Nishisuehiro-cho, Yokkaichi-shi, Mie-Ken 510-8503, Japan		
Date of Registration	21/11/2008	
Title	Light Bulb Socket	
Priority		
Priority Number	Date	Country
2008-013042	23/05/2008	Japan

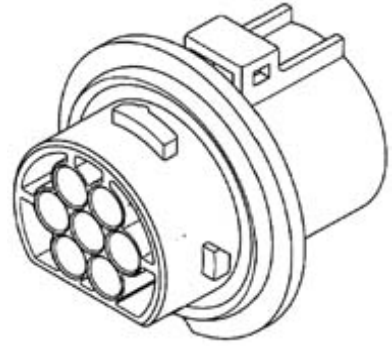



Design Number	219790	
Class	09-01	
1)Nirmal C. Rathod 2/13, Unnat Nagar No.2, Opp. New India Co-Op. Bank Ltd., M.G. Road, Goregaon (W), Mumbai-400062, Maharashtra, India		
Date of Registration	21/11/2008	
Title	Bottle	
Priority NA		



Design Number	219849	
Class	09-03	
1)Manjushree Extrusions Limited 60-E, Bommasandra Industrial Area, Hosur Road, Bangalore-560 099, Karnataka India		
Date of Registration	24/11/2008	
Title	Apple Jar	
Priority NA		



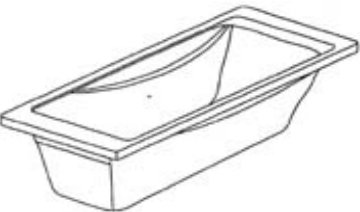

Design Number	219850	
Class	06-04	
1)Nilkamal Limited Survey No.-354/2 & 354/3, Near Rakholi Bridge, Silvassa, Khanvel Road, Village Vasona, Silvassa (D & N. H.), U. T., India		
Date of Registration	24/11/2008	
Title	Cabinet	
Priority NA		
Design Number	219904	
Class	12-16	
1)Clutch Auto Limited 12/4, Mathura Road, Faridabad, Haryana-121003, India		
Date of Registration	28/11/2008	
Title	Buttons	
Priority NA		
Design Number	219905	
Class	12-16	
1)Clutch Auto Limited 12/4, Mathura Road, Faridabad, Haryana-121003, India		
Date of Registration	28/11/2008	
Title	Buttons	
Priority NA		

Design Number	219909		
Class	12-16		
1)Clutch Auto Limited 12/4, Mathura Road, Faridabad, Haryana-121003, India			
Date of Registration	28/11/2008		
Title	Clutch Disc		
Priority NA			
Design Number	219937		
Class	23-02		
1)Kohler France Sas Immeuble Le Cap, 3, Rue De Brennus, 93631 LA Plaine St., denis Cedex, france			
Date of Registration	01/12/2008		
Title	Bidet		
Priority			
Priority Number	Date	Country	
000948054	09/06/2008	EUROPEAN UNION	
Design Number	220152		
Class	23-02		
1)Kohler France Sas Immeuble Le Cap, 3, Rue De Brennus, 93631 LA Plaine St., Denis Cedex, france			
Date of Registration	11/12/2008		
Title	Bathing Tub		
Priority			
Priority Number	Date	Country	
000943014	29/05/2008	EUROPEAN UNION	



Design Number	220438	
Class	13-99	
1)Naresh Matai 405, Hiren Industrial Estate, Mogal Lane, Mahim (W), Mumbai-400016, Maharashtra, India		
Date of Registration	24/12/2008	
Title	Tester	
Priority NA		
Design Number	220542	
Class	06-07	
1)Ma Design India Pvt Ltd., C-26, Sector-63, Noida-201301, U.P., India		
Date of Registration	29/12/2008	
Title	Photo Frame	
Priority NA		
Design Number	220543	
Class	06-07	
1)Ma Design India Pvt Ltd., C-26, Sector-63, Noida-201301, U.P., India		
Date of Registration	29/12/2008	
Title	Photo Frame	
Priority NA		

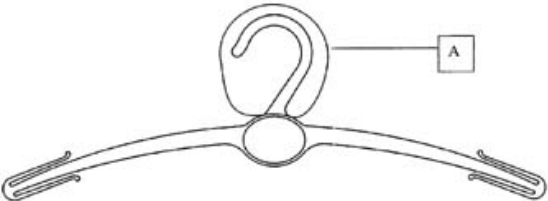

Design Number	220544	
Class	07-01	
1)Ma Design India Pvt Ltd., C-26, Sector-63, Noida-201301, U.P., India		
Date of Registration	29/12/2008	
Title	Cheese Board	
Priority NA		
Design Number	220547	
Class	07-01	
1)Ma Design India Pvt Ltd., C-26, Sector-63, Noida-201301, U.P., India		
Date of Registration	29/12/2008	
Title	Bowl	
Priority NA		
Design Number	220549	
Class	07-01	
1)Ma Design India Pvt Ltd., C-26, Sector-63, Noida-201301, U.P., India		
Date of Registration	29/12/2008	
Title	Dish	
Priority NA		

Design Number	220600	
Class	07-01	
1)Ma Design India Pvt Ltd., C-26, Sector-63, Noida-201301, U.P., India		
Date of Registration	31/12/2008	
Title	Dish	
Priority NA		

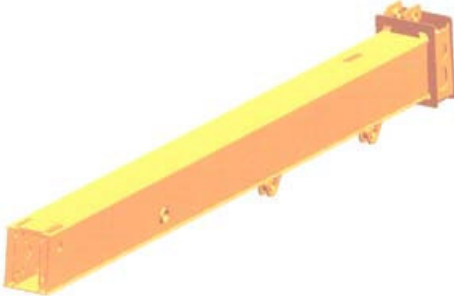
Design Number	220657	
Class	07-99	
1)MICROLIT., 629, Pakramau, Kurshi Road, Lucknow-226026, UP, India.		
Date of Registration	05/01/2009	
Title	Bottle Top Dispenser	
Priority NA		

Design Number	220785	
Class	06-08	
1)Mainetti (UK) Limited., Annfield Estate, Oxnam Road, Jedburgh, Roxburghshire, Scotland, TD8 6NN, UK.		
Date of Registration	15/01/2009	
Title	Garment Hanger	
Priority		
Priority Number	Date	
4008439	24/07/2008	U.K.

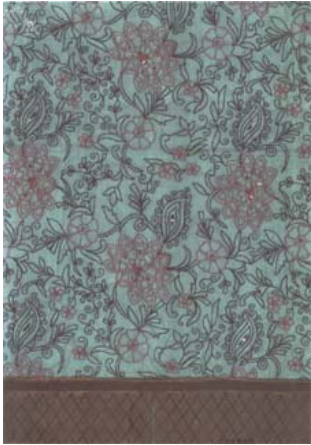
Design Number	220943		
Class	08-06		
1)MANISHBHAI BHIKHABHAI PATEL., 4 ATIKA INDUSTRIAL AREA, PATEL CHOWK, DHEBAR ROAD, (SOUTH), GUJARAT, INDIA. 2)Jay Shakti Metal			
Date of Registration	29/01/2009		
Title	Handle		
Priority NA			
Design Number	221001		
Class	12-16		
1)JCB India Limited B-1/1-1, 2nd Floor, Mohan Co-Operative Industrial Estate, Mathura Road, New Delhi, India			
Date of Registration	30/01/2009		
Title	Middle Boom for Pick and Carry Mobile Hydraulic Crane		
Priority NA			
Design Number	221005		
Class	08-04		
1)Robert Bosch Gmbh Postfach 30 02 20, 70442 Stuttgart, Germany			
Date of Registration	30/01/2009		
Title	Screwdriver		
Priority			
Priority Number	Date	Country	
000986864	13/08/2008	OHIM	

Design Number	221100	
Class	05-05	
1)Charming Apparels (P) Ltd., 402-405, 1st Floor, Main Road, Chandni Chowk, Delhi-110 006, India.		
Date of Registration	09/02/2009	
Title	Textile Fabric	
Priority NA		
Design Number	221278	
Class	09-03	
1)Nayasa Homeware., Survey No. 367/16 & 378/2 Kashigam Nani Daman, Daman-396 210, Daman Union Territories, India.		
Date of Registration	17/02/2009	
Title	Box	
Priority NA		
Design Number	221279	
Class	09-01	
1)Nayasa Homeware., Survey No. 367/16 & 378/2 Kachigam Nani Daman, Daman-396 210, Daman Union Territories, India.		
Date of Registration	17/02/2009	
Title	Bottle	
Priority NA		

Design Number	221670	
Class	08-06	
1)PNL Metalware Pvt. Ltd., Plot No. G-1843, Kishan Gate Road, G.I.D.C. Metoda (Lodhika), Taluka, Lodhika, Dist. Rajkot-360 021, Gujarat, India.		
Date of Registration	16/03/2009	
Title	Door Handle	
Priority NA		
Design Number	221817	
Class	09-01	
1)Nayasa Homeware., Survey No. 367/16 & 378/2 Kashigam Nani Daman, Daman-396 210, Daman Union Territories, India.		
Date of Registration	20/03/2009	
Title	Bottle	
Priority NA		