



CONTINUED FROM PART 2



INTRODUCTION

In view of the recent amendment made in the Designs (Amendment) Rules, 2008 with effect from 17/06/2008, Publication of the matter relating to Designs is being published in the Official Journal of The Patent Office. This Journal is being published on weekly basis on every Friday covering the various proceedings on Designs as required according to the provisions of under Rule 22, 25, 27 and 39 of the Design (Amendment) Rules, 2008. All the enquiries on this Official Journal and other information as required by the public should be addressed to the Controller General of Patents, Designs & Trade Marks. Suggestions and comments are requested from all quarters so that the content can be enriched.

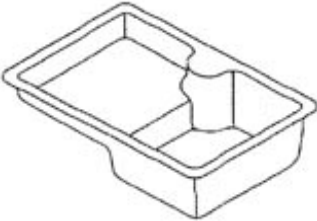
REGISTRATION OF DESIGNS

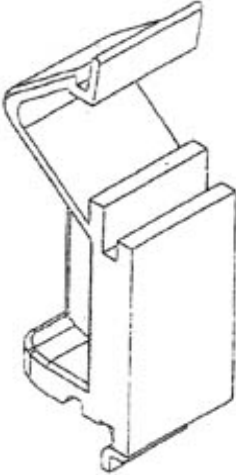

The following designs have been registered. They are now open for public inspection. In the following each entry the Date of Registration is shown. The Priority Number, Priority Date and Priority Country are also shown.

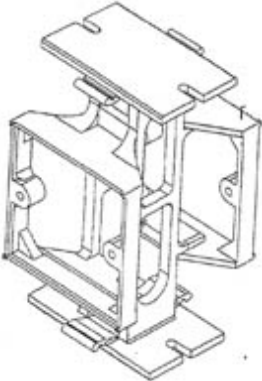

Design Number	213299	
Class	23-02	
1)Kohler Co., 444 Hihgland Drive Khohler Wisconsin 53044 United States Of America		
Date of Registration	04/05/2007	
Title	Sink	
Priority		
Priority Number	Date	
29/279,688	04/05/2007	U.S.A.
Design Number	213319	
Class	12-08	
1)Tata Motors Limited Bombay House, 24 Homi Mody Street, Mumbai 400 001, Maharashtra, India		
Date of Registration	06/11/2007	
Title	Vehicle	
Priority NA		
Design Number	213322	
Class	13-03	
1)Boparai Electricals & Electronics Malerkotla Road, P.O.Payal-141416, Punjab, India		
Date of Registration	07/11/2007	
Title	Single Phase Preventer	
Priority NA		

Design Number	213714		
Class	08-09		
1)Tomta Furniture Manufacturer SDN BHD No.135A & 135B, Jalan Kip 8, Taman Perindustrian KIP, 52200 Kuala Lumpur, Malaysia			
Date of Registration	10/10/2007		
Title	Clamp For Partition		
Priority			
Priority Number	Date	Country	
07-01460-0404	10/10/2007	Malaysia	
Design Number	213715		
Class	08-09		
1)Tomta Furniture Manufacturer SDN BHD No.135A & 135B, Jalan Kip 8, Taman Perindustrian Kip-52200 Kuala Lumpur, Malaysia			
Date of Registration	10/10/2007		
Title	Fitting for Partition		
Priority			
Priority Number	Date	Country	
07-01457-0104	10/10/2007	Malaysia	
Design Number	213718		
Class	08-09		
1)Tomta Furniture Manufacturer SDN BHD, No.135A & 135B, Jalan Kip 8, Taman Perindustrian Kip-52200 Kuala Lumpur, Malaysia			
Date of Registration	10/10/2007		
Title	Clamp for Partition		
Priority			
Priority Number	Date	Country	
07-01459-0304	10/10/2007	Malaysia	

Design Number	213769	
Class	09-01	
1)Tara Feed Limited Village Jitwal Kalan-148023, Tehsil, Malerkotla, Distt. Sangrur, Punjab, India		
Date of Registration	17/12/2007	
Title	Bottle	
Priority NA		
Design Number	213770	
Class	09-03	
1)Tara Feed Limited Village Jitwal Kalan, Tehsil, Malerkotla, Distt. Sangrur, Punjab, India		
Date of Registration	17/12/2007	
Title	Container	
Priority NA		
Design Number	213778	
Class	12-11	
1)M.S.Bhogal N. Sons 732, Industrial Area-B, Ludhiana, Punjab-141001, India.		
Date of Registration	17/12/2007	
Title	Shocker	
Priority NA		

Design Number	213780		
Class	09-03		
1)British American Tobacco (Investments) Limited Globe House, 1 Water Street, London, WC2R 3LA, UK.			
Date of Registration	19/06/2007		
Title	Cigarette Packet		
Priority			
Priority Number	Date	Country	
000745278	19/06/2007	OHIM	
Design Number	213805		
Class	13-02		
1)E-Tech Co., Ltd., #403-902, Techno Park Complex 193, Yakdae-Dong, Wonmi-Gu, Buchon, Korea			
Date of Registration	18/12/2007		
Title	Battery for FM Handheld Transceiver		
Priority NA			
Design Number	213895		
Class	26-06		
1)Hyundai Motor Company 231Yangjae-Dong, Seocho-ku Seoul, Republic of Korea			
Date of Registration	26/12/2007		
Title	Rear Combination Lamp for Automobile		
Priority			
Priority Number	Date	Country	
30-2007-0042560	12/10/2007	Korea(South)	

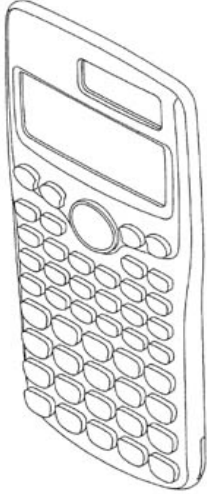

Design Number	213912						
Class	15-99						
1)M/s Sai Engineering Company Plot No.-5M-100, New Indl Town, Faridabad, Haryana, India.							
Date of Registration	28/12/2007						
Title	2/6 Tube Head						
Priority NA							
Design Number	214095						
Class	14-03						
1)Samsung Electronics Co.Ltd. 416 Metan-Dong, Paldal-Gu, Suwon-City, Kyungki-Do, Korea							
Date of Registration	10/10/2007						
Title	Mobile Phone						
Priority							
<table border="1"> <thead> <tr> <th>Priority Number</th> <th>Date</th> <th>Country</th> </tr> </thead> <tbody> <tr> <td>30-2007-0042181</td> <td>10/10/2007</td> <td>Korea(South)</td> </tr> </tbody> </table>	Priority Number	Date		Country	30-2007-0042181	10/10/2007	Korea(South)
Priority Number	Date	Country					
30-2007-0042181	10/10/2007	Korea(South)					
Design Number	214268						
Class	12-05						
1)M/S. Escorts Construction Equipment Limited Plot No. 2, Sector-13, Faridabad-121007, Haryana, India							
Date of Registration	16/01/2008						
Title	Crane						
Priority NA							



Design Number	214283		
Class	18-01		
1)Casio Keisanki Kabushiki Kaisha. 6-2, Hon-Machi 1-Chome, Shibuya-Ku, Tokyo, Japan.			
Date of Registration	16/01/2008		
Title	Electronic Calculator		
Priority NA			
Design Number	214334		
Class	04-02		
1)MR. S.B.GUPTA., VILLAGE THANA, MOREPEN ROAD, BADDI, HIMACHAL PRADESH-173 205, INDIA. 2)M/S Raghvan Life Style Products			
Date of Registration	18/01/2008		
Title	Tooth Brush Handle		
Priority NA			
Design Number	214375		
Class	08-03		
1)Kennametal Inc. 1600 Technology Way, Latrobe, PA 15650-0231, U.S.A.			
Date of Registration	27/07/2007		
Title	Cutting Inserts		
Priority			
Priority Number	Date	Country	
000765284	27/07/2007	OHIM	

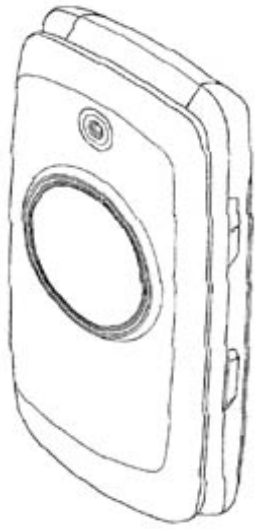

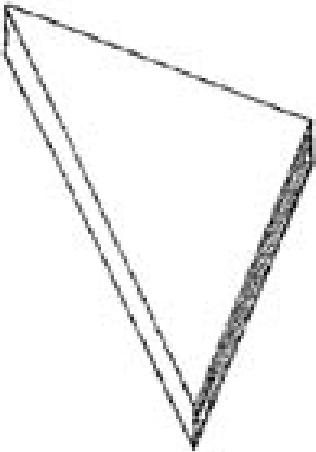
Design Number	214576		
Class	12-08		
1)Honda Motor Co.Ltd 1-1 Minami-Aoyama 2-Chome, Minato-Ku, Tokyo 107-8556, Japan			
Date of Registration	06/02/2008		
Title	Automobile		
Priority			
Priority Number	Date	Country	
2007-022616	22/08/2007	Japan	

Design Number	214583		
Class	02-02		
1)M/S Kashmir Loom Company Pvt. Ltd A-21 Nizamuddin East, New Delhi-110013, India			
Date of Registration	07/02/2008		
Title	Garment (Shawl)		
Priority NA			

Design Number	214594		
Class	14-03		
1)Samsung Electronics Co. Ltd., 416 Maetan-Dong, Yeongtong-Gu, Suwon-SI, Gyeonggi-Do, Republic of Korea			
Date of Registration	31/10/2007		
Title	Portable Phone		
Priority			
Priority Number	Date	Country	
30-2007-0045398	31/10/2007	Republic of Korea	

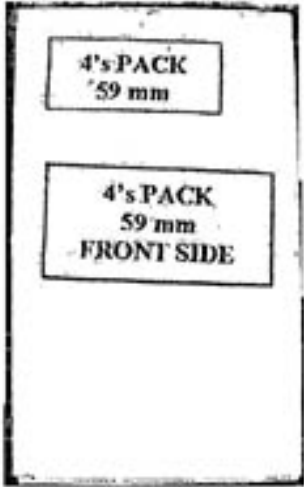

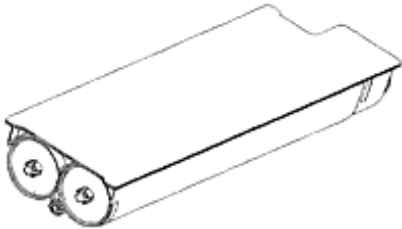
Design Number	214595		
Class	19-04		
1)Muccifora Paolo Via Luigi Ungarelli, 600100 Roma, Italy 2)Quinzi Daniele			
Date of Registration	08/08/2007		
Title	Magazine or Book		
Priority			
Priority Number	Date	Country	
000771407	08/08/2007	OHIM	
Design Number	214596		
Class	19-04		
1)Muccifora Paolo Via Luigi Ungarelli, 6 00100 Roma, Italy 2)Quinzi Daniele			
Date of Registration	07/02/2008		
Title	Magazine or Book		
Priority			
Priority Number	Date	Country	
000771407	08/08/2007	OHIM	
Design Number	214624		
Class	06-08		
1)Sinco Industries 595, Gali Bazazan, Sadar Bazar, Delhi-110006, India			
Date of Registration	08/02/2008		
Title	Cloth Clip		
Priority NA			

Design Number	214739	
Class	23-04	
1)Crompton Greaves Limited 6th Floor, CG House, Dr Annie Besant Road, Worli, Mumbai-400030, Maharashtra, India.		
Date of Registration	15/02/2008	
Title	Fan	
Priority NA		
Design Number	214742	
Class	23-04	
1)Crompton Greaves Limited 6th Floor, CG House, Dr. Annie Besant Road, Worli, Mumbai-400030, Maharashtra, India		
Date of Registration	15/02/2008	
Title	Fan	
Priority NA		
Design Number	214959	
Class	27-06	
1)GTC Industries Ltd Tobacco House, S.V.Road, Vile Parle (W), Mumbai-400056, Maharashtra, India		
Date of Registration	28/02/2008	
Title	Cigarette Case	
Priority NA		

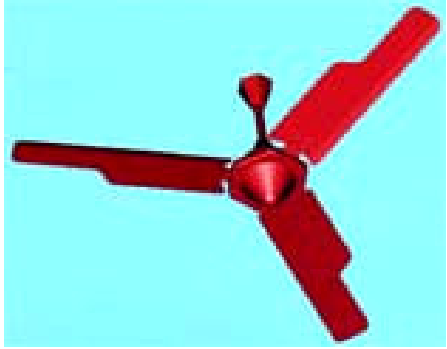
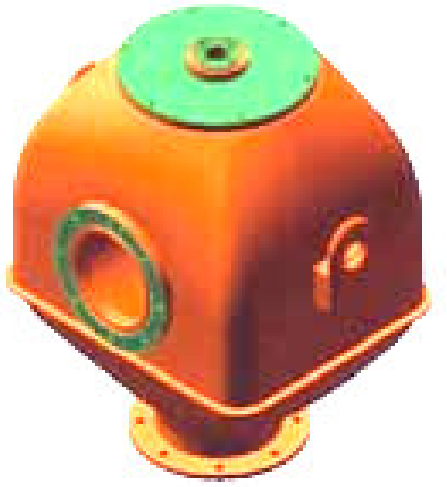
Design Number	214961		
Class	27-06		
1)GTC Industries Ltd Tobacco House, S.V.Road, Vile Parle (W), Mumbai-400056, Maharashtra, India			
Date of Registration	28/02/2008		
Title	Cigarette Cases		
Priority NA			
Design Number	215260		
Class	19-06		
1)Toshiba Tec Kabushiki Kaisha 2-17-2 Higashigotanda, Shinagawa-Ku, Tokyo, Japan			
Date of Registration	13/03/2008		
Title	Toner Cartridge		
Priority			
Priority Number	Date	Country	
2007-025012	14/09/2007	Japan	
Design Number	222233		
Class	13-99		
1)Crompton Greaves Limited 6th Floor, CG House, Dr. Annie Besant Road, Worli, Mumbai-400030, Maharashtra, India			
Date of Registration	01/04/2009		
Title	Stator Yoke		
Priority NA			

Design Number	222239	
Class	08-99	
1)Crompton Greaves Limited 6th Floor, CG House, Dr. Annie Besant Road, Worli, Mumbai-400030, Maharashtra, India		
Date of Registration	01/04/2009	
Title	Slip Rings for Motor	
Priority NA		
Design Number	222240	
Class	23-04	
1)Crompton Greaves Limited 6th Floor, CG House, Dr. Annie Besant Road, Worli, Mumbai-400030, Maharashtra, India		
Date of Registration	01/04/2009	
Title	Ceiling Fan	
Priority NA		
Design Number	222241	
Class	23-01	
1)Crompton Greaves Limited 6th Floor, CG House, Dr. Annie Besant Road, Worli, Mumbai-400030, Maharashtra, India		
Date of Registration	01/04/2009	
Title	Storage Tank	
Priority NA		

Design Number	222268		
Class	08-06		
1)PMS Enterprise 15/16, Samrat Industrial Area, B/H S. T. Workshop, Gondal Road, Rajkot-360004, Gujarat, India			
Date of Registration	03/04/2009		
Title	Handle		
Priority NA			
Design Number	222272		
Class	08-06		
1)Italik Metalware Pvt Ltd. G:212-215, Lodhika, G.I.D.C, Kalawad Road, Metoda, Rajkot-360003, Gujarat, India			
Date of Registration	03/04/2009		
Title	Handle		
Priority NA			
Design Number	222288		
Class	15-01		
1)Keihin Corporation 26-2, Nishishinjuku 1-Chome, Shinjuku-ku, Tokyo, Japan			
Date of Registration	03/04/2009		
Title	Carburator for Internal Combustion Engines		
Priority			
Priority Number	Date	Country	
2008-025778	07/10/2008	Japan	

Design Number	222321		
Class	07-02		
1)Bajaj Electricals Limited 45/47, Veer Nariman Road, Mumbai-400023, Maharashtra, India			
Date of Registration	08/04/2009		
Title	Mixer Grinder Jar		
Priority NA			
Design Number	222334		
Class	06-08		
1)Braitrim (UK) Limited Braitrim House, 98 Victoria Road, London NW 10 6NB, U.K.			
Date of Registration	08/04/2009		
Title	Clothes Hanger		
Priority			
Priority Number	Date	Country	
001018394-0018	08/10/2008	EUROPEAN UNION	
Design Number	222356		
Class	24-02		
1)Sanofi-Aventis Deutschland GMBH Bruningstrasse 50, 65929 Frankfurt, Germany			
Date of Registration	09/04/2009		
Title	Medical Injector		
Priority			
Priority Number	Date	Country	
001031249-0007	11/10/2008	OHIM	

Design Number	222359	
Class	24-02	
1)Sanofi-Aventis Deutschland GMBH Bruningstrasse 50, 65929 Frankfurt, Germany		
Date of Registration	09/04/2009	
Title	Medical Injector	
Priority		
Priority Number	Date	Country
001031249-0004	11/10/2008	OHIM



Design Number	222446	
Class	15-03	
1)Kartar Agro Industries (P) Ltd. Amloh Road, Bhadson, Distt. Patiala, Punjab, India		
Date of Registration	17/04/2009	
Title	Self Propelled Harvester Combine	
Priority NA		







Design Number	222531	
Class	25-01	
1)Arun Kumar "Arun Nivas" 491, 7th Street Extention, Gandhipuram, Coimbatore-641012. India		
Date of Registration	21/04/2009	
Title	Concrete Cover Block	
Priority NA		

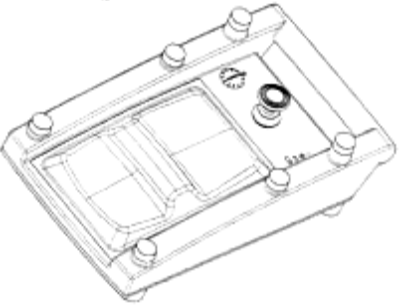

Design Number	222632	
Class	26-02	
1)M/S. Mitra Trading Co. 18A, Ramdhone Mitra Lane, Kolkata-700004, West Bengal, India		
Date of Registration	29/04/2009	
Title	Torch	
Priority NA		
Design Number	222646	
Class	09-01	
1)Pearl Polymers Limited B-59, Greater Kailash, Part-I, New Delhi--110048, India		
Date of Registration	30/04/2009	
Title	Bottle	
Priority NA		
Design Number	222656	
Class	12-16	
1)Auto Plast (India) B-2369, DSISC Industrial Estate, Narela, Delhi-110040, Delhi, India		
Date of Registration	30/04/2009	
Title	Back Rest For Bicycles and Tricycles	
Priority NA		

Design Number	222725	
Class	06-11	
1)Jaipur Rugs Co. Pvt. Ltd. G-250, Mansarovar Industrial Area, Jaipur -302020		
Date of Registration	04/05/2009	
Title	Carpet	
Priority NA		
Design Number	222727	
Class	06-11	
1)Jaipur Rugs Co. Pvt. Ltd. G-250, Mansarovar Industrial Area, Jaipur -302020		
Date of Registration	04/05/2009	
Title	Carpet	
Priority NA		
Design Number	222730	
Class	06-11	
1)Jaipur Rugs Co. Pvt. Ltd. G-250, Mansarovar Industrial Area, Jaipur -302020		
Date of Registration	04/05/2009	
Title	Carpet	
Priority NA		

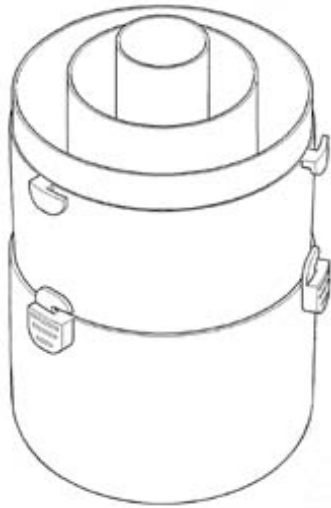
Design Number	222731		
Class	06-11		
1)Jaipur Rugs Co. Pvt. Ltd. G-250, Mansarovar Industrial Area, Jaipur -302020			
Date of Registration	04/05/2009		
Title	Carpet		
Priority NA			
Design Number	222753		
Class	16-99		
1)Carl Zeiss Surgical GmbH Carl-Zeiss-StraÙe 22, 73447 Oberkochen			
Date of Registration	04/05/2009		
Title	Foot Switch		
Priority			
Priority Number	Date	Country	
001037501	12/11/2008	OHIM	
Design Number	222821		
Class	09-01		
1)Loba Chemie Private Limited Jehangir Villa, 107, Wode House Road, Colaba, Mumbai 400 005, Maharashtra, India			
Date of Registration	08/05/2009		
Title	Bottle		
Priority NA			

Design Number	222852		
Class	19-99		
1)Morris Corporation 952 Dohwa-dong, Nam-Gu, Inchon-Shi 402-060, Korea			
Date of Registration	12/05/2009		
Title	Display Stand for Writing Tools		
Priority NA			
Design Number	222863		
Class	19-06		
1)Pidilite Industries Limited Regent Chamber, 7th Floor, Jamnalal Bajaj Marg, 208, Nariman Point, Mumbai 400 021, Maharashtra, India			
Date of Registration	13/05/2009		
Title	Nozzle		
Priority NA			
Design Number	222982		
Class	23-01		
1)Obshtshestvo S Ogranichennoy Otvetstvennostyu Firma Ratna B. Semenovskaya Str. 42/2-2, Bldg. 2, 105094 Moscow, Russian Federation			
Date of Registration	25/05/2009		
Title	Water Filter		
Priority			
Priority Number	Date	Country	
2008-504 632	29/12/2008	Russia	

Design Number	222998	
Class	02-04	
1)Global Footwear & Leather Craft Industries No.1 Ripon Street, Kolkata-700016, West Bengal, India		
Date of Registration	26/05/2009	
Title	Footwear	
Priority NA		

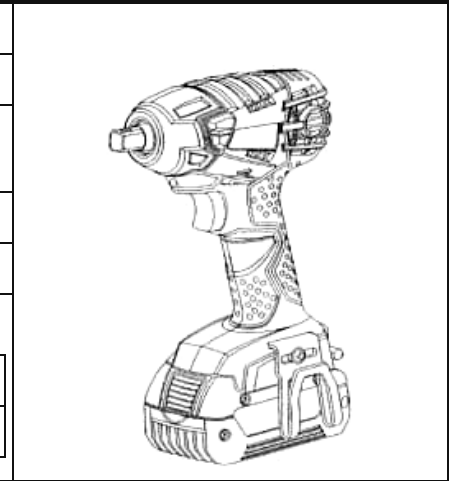

Design Number	223036	
Class	08-05	
1)Robert Boch GmbH Postfach 30 02 20, 70442 stuttgart, Germany		
Date of Registration	27/05/2009	
Title	Impact Wrenches	
Priority		
Priority Number	Date	Country
001061477	22/12/2008	OHIM



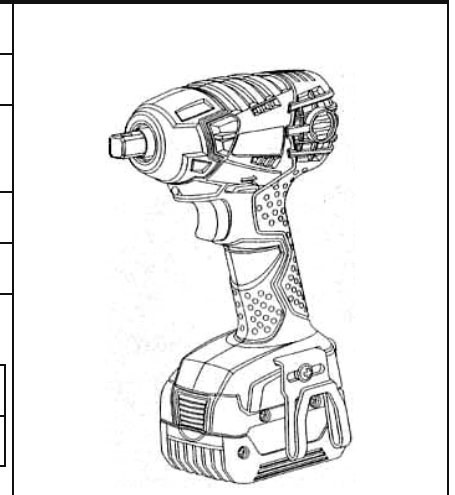

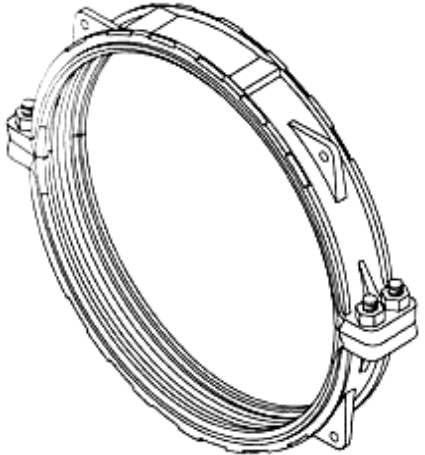
Design Number	223037	
Class	08-05	
1)Robert Boch GmbH Postfach 30 02 20, 70442 stuttgart, Germany		
Date of Registration	27/05/2009	
Title	Impact Wrenches	
Priority		
Priority Number	Date	Country
001061477	22/12/2008	OHIM

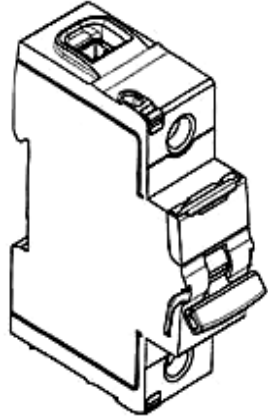
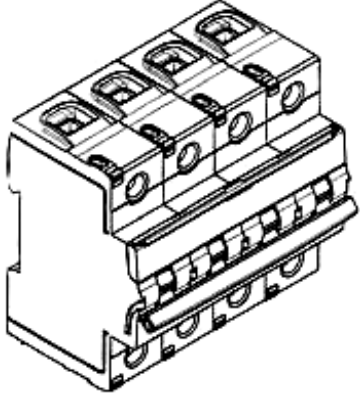

Design Number	223070		
Class	04-01		
1) Mascot Corporation 152, Narayan Dhuru Street, 2nd Floor, Mumbai -400 003., Maharashtra, India			
Date of Registration	29/05/2009		
Title	Scrubber		
Priority NA			
Design Number	223077		
Class	15-99		
1) Victualic Company 4901 Kesslersville Road, Easton, Pennsylvania 18040, USA			
Date of Registration	29/05/2009		
Title	Flexible Pipe Coupling		
Priority			
Priority Number	Date	Country	
29/328,916	04/12/2009	U.S.A.	
Priority NA			
Design Number	223078		
Class	09-01		
1) Yadav Mahesh Bhagwansinh 255, Lane No. 13, Satyagrah Chavani, Ahmedabad-380 015, Gujarat, India			
Date of Registration	29/05/2009		
Title	Dispenser		
Priority NA			

Design Number	223169		
Class	13-03		
1)Legrand France 128 Avenue Du Marechal De Lattre-De-Tassigny FR-87000 Limoges-France 2)Legrand Snc			
Date of Registration	03/06/2009		
Title	Modular Electric Apparatus		
Priority			
Priority Number	Date	Country	
001068829	10/12/2008	OHIM	
Design Number	223170		
Class	13-03		
1)Legrand France 128 Avenue Du Marechal De Lattre-De-Tassigny FR-87000 Limoges-France 2)Legrand Snc			
Date of Registration	03/06/2009		
Title	Modular Electric Apparatus		
Priority			
Priority Number	Date	Country	
001068829	10/12/2008	OHIM	
Design Number	223552		
Class	07-02		
1)Nayasa Homeware Survey No. 367/16 & 378/2 Kachigam, Nani Daman, Daman - 396 210, (Union Territories) Daman Union Territories, India			
Date of Registration	25/06/2009		
Title	Casserole		
Priority NA			

Design Number	224943	
Class	12-16	
1)Searose Exim Pvt. Ltd. K-292, Phase-VIII, Focal Point, Ludhiana-141010 (Punjab) (India)		
Date of Registration	30/09/2009	
Title	Basket for Bicycle	
Priority NA		
Design Number	224945	
Class	19-06	
1)S.S.B. Metal Works K.Yunus bldg., 2nd floor, Vishweshwar Nagar Road, Off. Aarey Road, Goregaon (E) Mumbai-400063, State of Maharashtra, (India)		
Date of Registration	30/09/2009	
Title	Ball Point Pen	
Priority NA		