

CONTINUED FROM PART 1

INTRODUCTION

In view of the recent amendment made in the Designs (Amendment) Rules, 2008 with effect from 17/06/2008, Publication of the matter relating to Designs is being published in the Official Journal of The Patent Office. This Journal is being published on weekly basis on every Friday covering the various proceedings on Designs as required according to the provisions of under Rule 22, 25, 27 and 39 of the Design (Amendment) Rules, 2008. All the enquiries on this Official Journal and other information as required by the public should be addressed to the Controller General of Patents, Designs & Trade Marks. Suggestions and comments are requested from all quarters so that the content can be enriched.

REGISTRATION OF DESIGNS

The following designs have been registered. They are now open for public inspection. In the following each entry the Date of Registration is shown. The Priority Number, Priority Date and Priority Country are also shown.

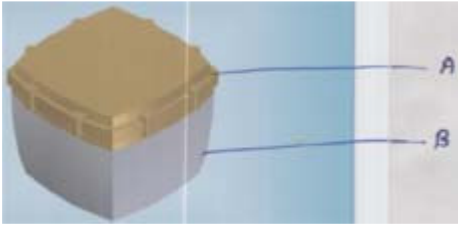
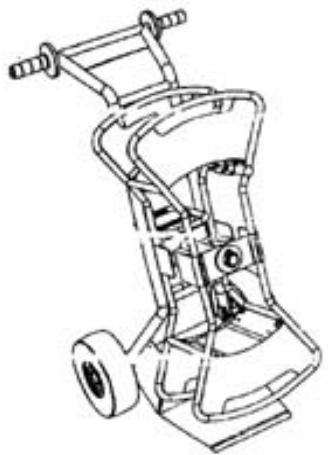
Number	202849		
Class	08-06		
1)Hosmimoto Co., Ltd. (JP) 2-24-32, Nakagawanishi, Ikuno-Ku, Osaka, Japan			
Date of Registration	10/08/2005		
Title	Handle for a Panel of Electrical Equipment		
Priority			
Priority Number	Date	Country	
2005-023188	10/08/2005	Japan	
Design Number			
	206563		
Class	09-00		
1)French Cosmetics Pvt. Ltd., Baroda, Jambusar N. High way Road, At & Po., Dabhasa Ta. Padra-391440, Dist. Baroda (Gujarat), India			
Date of Registration	17/10/2006		
Title	Container		
Priority NA			
Design Number	209001		
Class	99-01		
1)Dethier Livin Fermand Georges Leemkuilstraat 144, 3570 Alken, Belgium			
Date of Registration	21/03/2007		
Title	Cart		
Priority			
Priority Number	Date	Country	
82108-00	21/09/2006	EUROPEAN UNION	

Design Number	210602	
Class	13-03	
1)LEGRAND FRANCE 128, AVENUE DU MARECHAL DE LATTRE-DE-TASSIGNY, FR-87000 LIMOGES (FRANCE)		
Date of Registration	04/06/2007	
Title	Plate for Electrical Switch Board	
Priority		
Priority Number	Date	Country
000646047	07/12/2006	EUROPEAN UNION

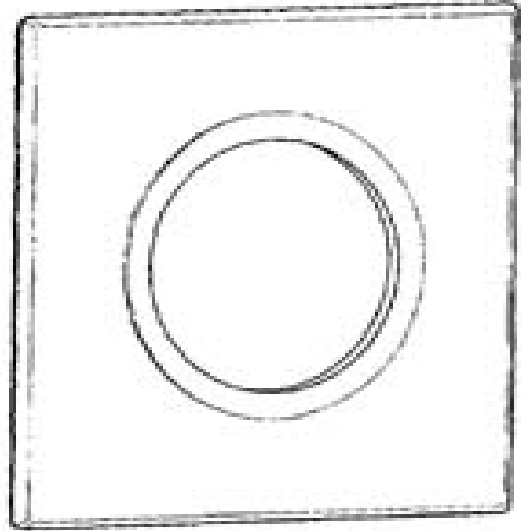

Design Number	213418	
Class	23-01	
1)Toyox Co., Ltd., 4371, Maezawa, Kurobe-Shi, Toyama-Ken, Japan.		
Date of Registration	13/11/2007	
Title	Hose	
Priority		
Priority Number	Date	Country
2007-015438	11/06/2007	Japan



Design Number	213431	
Class	12-16	
1)Piolax Inc., 51 Lwai-Cho, Hodogya-Ku, Yokohama-Shi, Kanagawa-Ken, Japan.		
Date of Registration	15/11/2007	
Title	Apparatus for Fixing Automobile Parts	

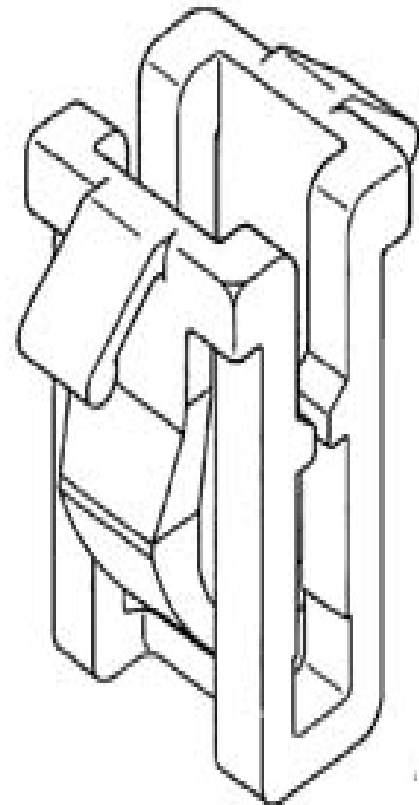

Priority NA		
-------------	--	--

Design Number	215080
Class	06-13
1)Eicher Goodearth Limited., Eicher House, 12 Commercial Complex, Greater Kailash-Ii (Masjid Moth), New Delhi-110 048, India.	
Date of Registration	03/03/2008
Title	Bed Spread
Priority NA	





Design Number	215249
Class	13-01
1)Crompton Greaves Limited 6th Floor, CG House, DR Annie Besant Road, Worli, Mumbai-400 030, Maharashtra, India.	
Date of Registration	12/03/2008
Title	Alternator
Priority NA	

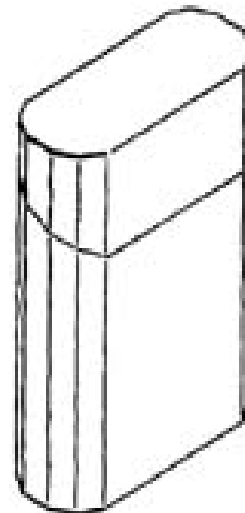

Design Number	215469
Class	09-03
1)Focke & Co. (GmbH & Co. Kg) Siemensstrasse 10, 27283 Verden, Germany.	
Date of Registration	25/03/2008
Title	Cigarette Packet
Priority NA	



Design Number	215528	
Class	05-02	
1)M/S. Sinhal Udyog. 820, Belgium Chamber, Delhi Gate, Surat-395 003, Gujrat, India.		
Date of Registration	27/03/2008	
Title	Tooth Brush	
Priority NA		
Design Number	216349	
Class	07-08	
1)S.S.VARSHNEY, MRS. RENU VARSHNEY AND MR. ATUL GUPTA., P.O.BOX NO. 146, I.T.I.ROAD, ALIGARH-202 001, UP, INDIA. 2)M/s Liberty Brass nternationale		
Date of Registration	16/05/2008	
Title	Fire Frets	
Priority NA		
Design Number	216350	
Class	07-08	
1)S.S.VARSHNEY, MRS. RENU VARSHNEY AND MR. ATUL GUPTA., P.O.BOX NO. 146, I.T.I.ROAD, ALIGARH-202 001, UP, INDIA. 2)M/s Liberty Brass nternationale		
Date of Registration	16/05/2008	
Title	Fire Frets	
Priority NA		

Design Number	216352	
Class	07-08	
1)S.S.VARSHNEY, MRS. RENU VARSHNEY AND MR. ATUL GUPTA., P.O.BOX NO. 146, I.T.I.ROAD, ALIGARH-202 001, UP, INDIA. 2)M/s Liberty Brass nternationale		
Date of Registration	16/05/2008	
Title	Fire Frets	
Priority NA		
Design Number	216452	
Class	15-03	
1)CORONA STEEL INDUSTRIES (P) LTD., P-34 INDIA EXCHANGE PLACE, KOLKATA-700 001, WB, INDIA.		
Date of Registration	27/05/2008	
Title	Agricultural Implement	
Priority NA		
Design Number	216635	
Class	12-05	
1)M/S. Escorts Construction Equipment Limited Plot No. 2, Sector-13, Faridabad-121 007, India		
Date of Registration	13/06/2008	
Title	Cabin	
Priority NA		

Design Number	216655	
Class	12-05	
1)Om Carrelli Elevatori S.P.A., Viale A. DE Gasperi, 7, I-20020 Lainate (MI), Itlay		
Date of Registration	13/06/2008	
Title	Fork-Lift-Truck	
Priority		
Priority Number	Date	Country
000843081-0001	14/12/2007	OHIM





Design Number	217569	
Class	01-01	
1)Frito Lay Trading Company Gmbh Spitalgasse 2, CH 3011 Bern, Switzerland		
Date of Registration	06/08/2008	
Title	Snacks	
Priority NA		



Design Number	218281	
Class	07-01	
1)Ravissant Pvt. Ltd. 50-51, Commercial Complex, New Friends Colony, New Delhi- 110065. India		
Date of Registration	01/09/2008	
Title	Bowl	
Priority NA		



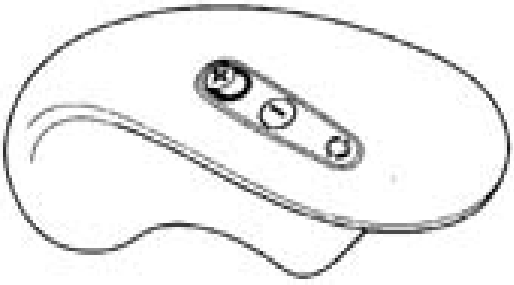



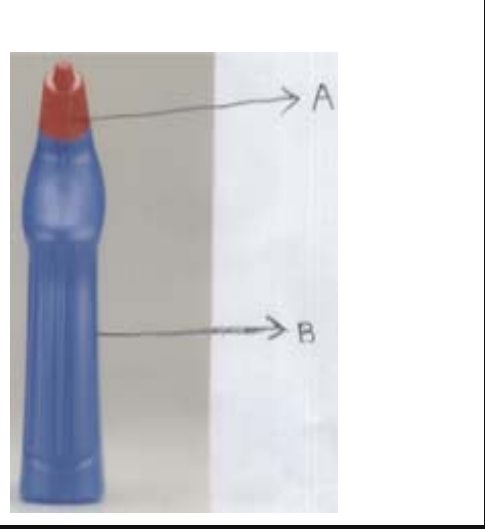
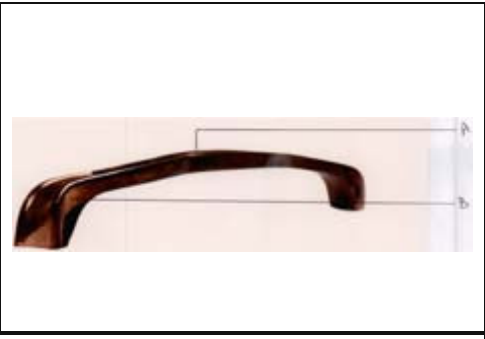

Design Number	218282	
Class	26-05	
1)Ravissant Pvt. Ltd. 50-51, Commercial Complex, New Friends Colony, New Delhi-110065. India		
Date of Registration	01/09/2008	
Title	Candle Stand	
Priority NA		
		
Design Number	218301	
Class	07-01	
1)Ravissant Pvt. Ltd. 50-51, Commercial Complex, New Friends Colony, New Delhi-110065. India		
Date of Registration	01/09/2008	
Title	Bowl	
Priority NA		
		
Design Number	218442	
Class	28-03	
1)Koninklijke Philips Electronics N.V. Groenewoudseweg 1, 5621 BA Eindhoven, The Netherlands		
Date of Registration	08/09/2008	
Title	Massager Female	
Priority		
Priority Number	Date	Country
00893367-0002	07/03/2008	OHIM
		

Design Number	218520		
Class	10-02		
1)Luxury Timepieces International SA Ch. Des Rochettes 2, 2016 Cortaillod, Switzerland			
Date of Registration	11/09/2008		
Title	Watch		
Priority			
Priority Number	Date	Country	
134957	27/03/2008	Switzerland	
Design Number	218686		
Class	08-06		
1)PMS Interprise 15/16, Samrat Industrial Area, B/H S. T. Workshop, Gondal Road, Rajkot-360 004, Gujarat, India			
Date of Registration	23/09/2008		
Title	Handle		
Priority NA			
Design Number	218687		
Class	08-06		
1)PMS Interprise 15/16, Samrat Industrial Area, B/H S. T. Workshop, Gondal Road, Rajkot-360 004, Gujarat, India			
Date of Registration	23/09/2008		
Title	Handle		
Priority NA			

Design Number	218688	
Class	08-06	
1)PMS Interprise 15/16, Samrat Industrial Area, B/H S. T. Workshop, Gondal Road, Rajkot-360004, Gujarat, India		
Date of Registration	23/09/2008	
Title	Handle	
Priority NA		
Design Number	218944	
Class	09-01	
1)Bharat Plastics Products 22/A Todi Industrial Estate, Sunmill Compound, Lower Parel, Mumbai-400013, Maharashtra, India		
Date of Registration	03/10/2008	
Title	Bottle	
Priority NA		
Design Number	219177	
Class	12-15	
1)Continental Aktiengesellschaft Vahernwalder Strasse 9, D-30165 Hannover, Germany		
Date of Registration	15/10/2008	
Title	Tyre	
Priority		
Priority Number	Date	Country
000970819	16/06/2008	OHIM





Design Number	219206	
Class	19-06	
1)S.S.B. Metal Works K. Yunus Bldg., 2nd Floor, Vishweshwar Nagar Road, Off. Aarey Road, Goregaon (E), Mumbai-400063, Maharashtra, India		
Date of Registration	16/10/2008	
Title	Pen	
Priority NA		
Design Number	219450	
Class	11-01	
1)M/s Sayani Metal Works 13, Shripal Service Industrial Estate, Near Pawan Baug, Chincholi Phatak "x" Road, Malad (W), Mumbai-400064, India		
Date of Registration	27/10/2008	
Title	Ear Ring Set	
Priority NA		
Design Number	219451	
Class	11-01	
1)M/s Sayani Metal Works 13, Shripal Service Industrial Estate, Near Pawan Baug, Chincholi Phatak "x" Road, Malad (W), Mumbai-400064, India		
Date of Registration	27/10/2008	
Title	Ear Ring Set	
Priority NA		

Design Number	219475	
Class	19-07	
1)Sharma Exports B-16, Sports & Surgical Complex, Kapurthala Road, Jalandhar-144 021 (Punjab) India		
Date of Registration	29/10/2008	
Title	Ball (Educational)	
Priority NA		
Design Number	219476	
Class	19-07	
1)Sharma Exports B-16, Sports & Surgical Complex, Kapurthala Road, Jalandhar-144 021 (Punjab) India		
Date of Registration	29/10/2008	
Title	Ball (Educational)	
Priority NA		
Design Number	219477	
Class	19-07	
1)Sharma Exports B-16, Sports & Surgical Complex, Kapurthala Road, Jalandhar-144 021 (Punjab) India		
Date of Registration	29/10/2008	
Title	Ball (Educational)	
Priority NA		

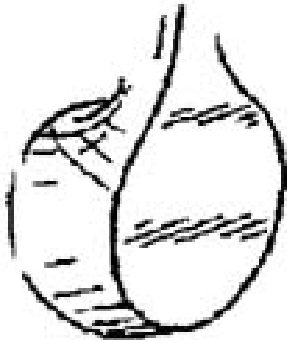

Design Number	219622		
Class	08-06		
1)PMS Interprise 15/16, Samrat Industrial Area, B/H S. T. Workshop, Gondal Road, Rajkot-360 004, Gujarat, India			
Date of Registration	10/11/2008		
Title	Handle		
Priority NA			
Design Number	219654		
Class	14-03		
1)Giorgio Armai S. P. A. Via Borgonuovo, 11, I-20121 Milano, Italy			
Date of Registration	12/11/2008		
Title	Mobile Phone		
Priority			
Priority Number	Date	Country	
000936786	20/05/2008	OHIM	
Priority NA			
Design Number	219689		
Class	08-06		
1)M/s Solar Industries K-1240, Aji G. I. D. C. Phase-II Rajkot, Gujarat, India			
Date of Registration	14/11/2008		
Title	Handle		
Priority NA			

Design Number	219698	
Class	09-01	
1)Paras Products 49A, Bombay Cotton Mills Estate, D. L. Marg, Kala Chowki, Mumbai 400 033, Maharashtra, India		
Date of Registration	14/11/2008	
Title	Plastic Container	
Priority NA		
Design Number	219705	
Class	15-09	
1)Sant Machine Tools Corporation 2nd Street, Kalsi Nagar, Dholewal, G. T. Road, Ludhiana-141 003 (Punjab), India		
Date of Registration	17/11/2008	
Title	Lathe-Machine	
Priority NA		
Design Number	219706	
Class	15-09	
1)N.S. Birla Industries (Regd.) 11198/1, Pratap Nagar, Street No-4, Ludhiana-141003, Punjab, India		
Date of Registration	17/11/2008	
Title	Machines for Manufacturing Cycle- Mudgaurds	
Priority NA		



Design Number	219765	
Class	23-01	
1)Kohler Co., 444 Highland Drive, Kohler, Wisconsin, 53044, United States of America		
Date of Registration	19/11/2008	
Title	Faucet Handle	
Priority NA		

Design Number	219766	
Class	24-99	
1)Piramal Healthcare Limited Piramal Towers, Ganpatrao Kadam Marg, Lower parcel, Mumbai 400013, Maharashtra, India		
Date of Registration	19/11/2008	
Title	Pen Like Tablet Dispenser	
Priority NA		

Design Number	219813	
Class	08-07	
1)M/s Nevil Interprise 80 Feet Road, Behind K. Rasiklal, 5 Ramnagar, Rajkot-360 003, Gujarat State, India		
Date of Registration	21/11/2008	
Title	Handle	
Priority NA		

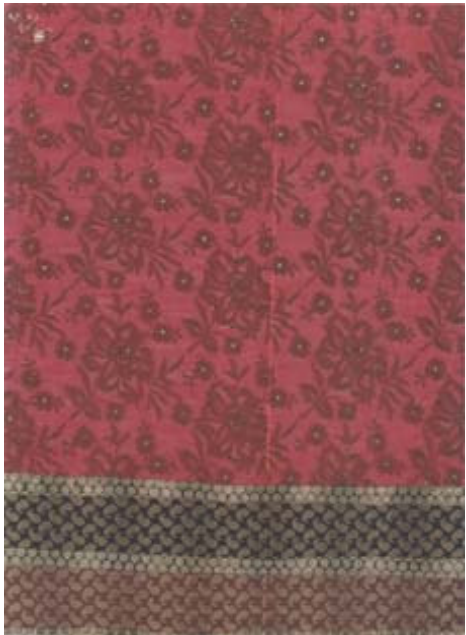
Design Number	219893	
Class	23-04	
1)Pradeepkumar Nandalal Dhoot Gangapurwala, 2275 Adat Bazar, Ahmednagar-414 001, Maharashtra, India		
Date of Registration	28/11/2008	
Title	Cooler	
Priority NA		
Design Number	219921	
Class	05-05	
1)Charming Apparels (P) Ltd., 402-405, 1st Floor, Main Road, Chandni Chowk, Delhi-110006, India		
Date of Registration	01/12/2008	
Title	Textile Fabric	
Priority NA		
Design Number	219924	
Class	05-05	
1)Charming Apparels (P) Ltd., 402-405, 1st Floor, Main Road, Chandni Chowk, Delhi-110006, India		
Date of Registration	01/12/2008	
Title	Textile Fabric	
Priority NA		

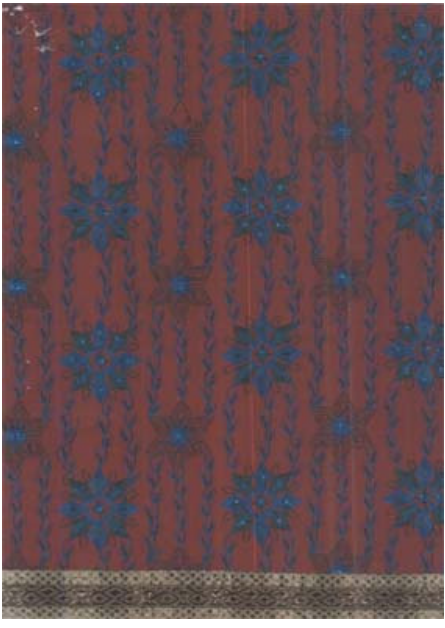
Design Number	219925	
Class	05-05	
1)Charming Apparels (P) Ltd., 402-405, 1st Floor, Main Road, Chandni Chowk, Delhi-110006, India		
Date of Registration	01/12/2008	
Title	Textile Fabric	
Priority NA		
Design Number	219928	
Class	05-05	
1)Charming Apparels (P) Ltd., 402-405, 1st Floor, Main Road, Chandni Chowk, Delhi-110006, India		
Date of Registration	01/12/2008	
Title	Textile Fabric	
Priority NA		
Design Number	219929	
Class	05-05	
1)Charming Apparels (P) Ltd., 402-405, 1st Floor, Main Road, Chandni Chowk, Delhi-110006, India		
Date of Registration	01/12/2008	
Title	Textile Fabric	
Priority NA		

Design Number	219934		
Class	05-05		
1)Charming Apparels (P) Ltd., 402-405, 1st Floor, Main Road, Chandni Chowk, Delhi-110006, India			
Date of Registration	01/12/2008		
Title	Textile Fabric		
Priority NA			
Design Number	220129		
Class	26-06		
1)Honda Motor Co., Ltd., 1-1, Minami-Aoyama 2-Chome, Minato-Ku, Tokyo, Japan.			
Date of Registration	10/12/2008		
Title	Rear Combination Lamp for Automobiles		
Priority			
Priority Number	Date	Country	
2008-014765	10/06/2008	Japan	
Design Number	220195		
Class	02-02		
1)RBK International Academy Opp. Indian Oil Nagar, Ghatkopar-Mankhurd Link Road, Chembur, Mumbai-400 088, Maharashtra, India			
Date of Registration	15/12/2008		
Title	T-Shirt		
Priority NA			



Design Number	220196	
Class	02-02	
1)RBK International Academy Opp. Indian Oil Nagar, Ghatkopar-Mankhurd Link Road, Chembur, Mumbai-400 088, Maharashtra, India		
Date of Registration	15/12/2008	
Title	Short Pant	
Priority NA		

Design Number	220197	
Class	02-02	
1)RBK International Academy Opp. Indian Oil Nagar, Ghatkopar-Mankhurd Link Road, Chembur, Mumbai-400 088, Maharashtra, India		
Date of Registration	15/12/2008	
Title	Pant	
Priority NA		

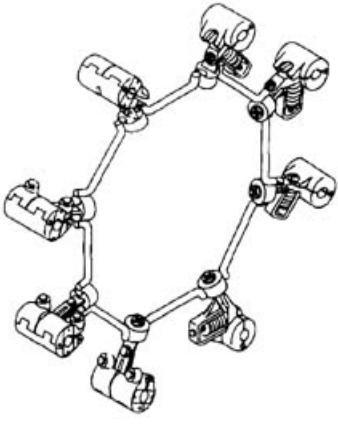
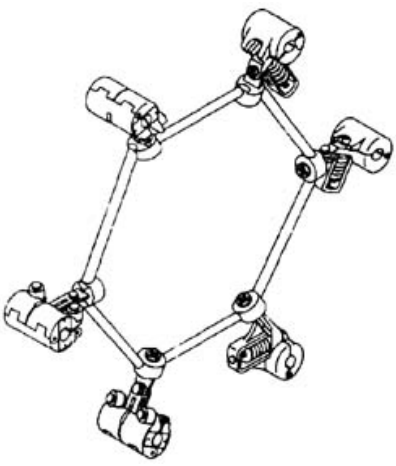
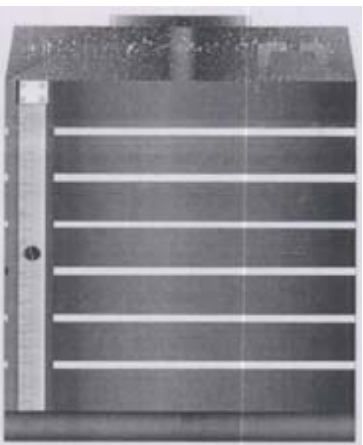

Design Number	220293	
Class	13-99	
1)Naresh Matai 405, Hiren Industrial Estate, Mongal Lane, Mahim (W), Mumbai-400016, Maharashtra, India		
Date of Registration	18/12/2008	
Title	Tester	
Priority NA		

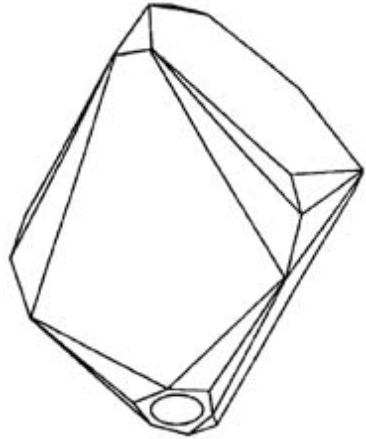
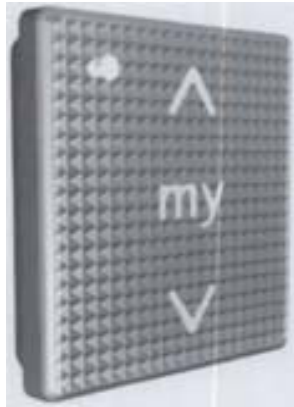
Design Number	220294	
Class	13-99	
1)Naresh Matai 405, Hiren Industrial Estate, Mongal Lane, Mahim (W), Mumbai-400016, Maharashtra, India		
Date of Registration	18/12/2008	
Title	Tester	
Priority NA		
Design Number	220296	
Class	13-99	
1)Naresh Matai 405, Hiren Industrial Estate, Mongal Lane, Mahim (W), Mumbai-400016, Maharashtra, India		
Date of Registration	18/12/2008	
Title	Tester	
Priority NA		
Design Number	220298	
Class	13-99	
1)Naresh Matai 405, Hiren Industrial Estate, Mongal Lane, Mahim (W), Mumbai-400016, Maharashtra, India		
Date of Registration	18/12/2008	
Title	Tester	
Priority NA		

Design Number	220309	
Class	13-03	
1)Asahi Electric Works, Ltd. 2-11-16, Azamino-Minami, Aoba-ku, Yokohama-shi, kanagawa-ken, Japan		
Date of Registration	18/12/2008	
Title	Spacer for Overhead Transmission Line Conductor	
Priority NA		
Design Number	220310	
Class	13-03	
1)Asahi Electric Works, Ltd. 2-11-16, Azamino-Minami, Aoba-ku, Yokohama-shi, kanagawa-ken, Japan		
Date of Registration	18/12/2008	
Title	Spacer for Overhead Transmission Line Conductor	
Priority NA		
Design Number	220407	
Class	09-02	
1)tulsibhai dfasjf 2)Tulshibhai Kanjibhai Patel		
Date of Registration	23/12/2008	
Title	Plastic Storage Tank	
Priority NA		

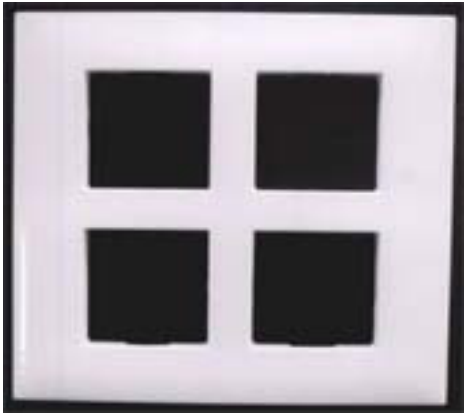
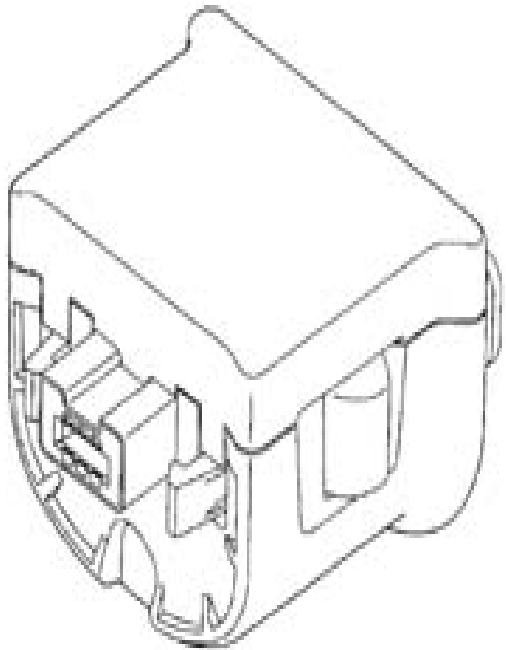
Design Number	220429		
Class	11-02		
1)Swarovski Aktiengesellschaft Droschstrabe, FL-9495 Triesen, Liechtenstein			
Date of Registration	23/12/2008		
Title	Ornamental Object		
Priority			
Priority Number	Date	Country	
956347-0005	23/06/2008	OHIM	
Design Number	220436		
Class	13-03		
1)Somfy Sas 50, Avenue du Nouveau Monde, 74300 Cluses, France			
Date of Registration	23/12/2008		
Title	Switch		
Priority			
Priority Number	Date	Country	
000958012-0008	25/06/2008	OHIM	
Design Number	220470		
Class	08-06		
1)Die-Cast Industries Plot No. 209/210, N - Road, Aji G. I. D. C. Phase-II, Rajkot-360003, Gujarat State, India			
Date of Registration	24/12/2008		
Title	Handle		
Priority NA			

Design Number	220488	
Class	09-05	
1)Navarang Tin Printers 603/604 Laxmi Palace, Soni Moni Showroom, S. V. Road, Borivali (W), Mumbai-400 092, Maharashtra, India		
Date of Registration	24/12/2008	
Title	Packaging	
Priority NA		
Design Number	220517	
Class	13-03	
1)Cosmo Electro Industries Pvt. Ltd. 522, Laxmi Plaza, Laxmi Industrial Estate, New Link Road, Andheri (West), Mumbai-400053, Maharashtra, India		
Date of Registration	29/12/2008	
Title	Switch Plate	
Priority NA		
Design Number	220592	
Class	21-02	
1)Nintendo Co., Ltd., 11-1, Hokotate-cho, Kamitoba, Minami-ku, Kyoto-shi, Kyoto, Japan		
Date of Registration	30/12/2008	
Title	Controller Expander	
Priority NA		

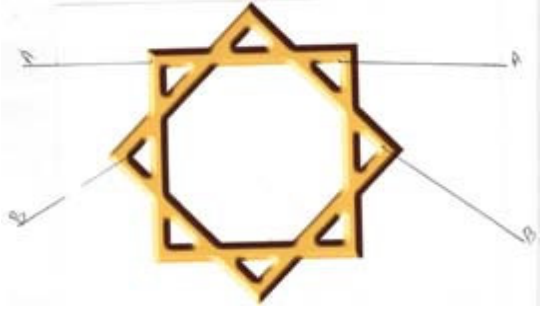
Design Number	220681	
Class	18-99	
1)NAVRANG TIN PRINTERS., 603/604, LAXMI PALACE, SONI MONI SHOWROOM, S.V.ROAD, BORIVALI (W), MUMBAI-400 092, MAHARASHTRA, INDIA.		
Date of Registration	06/01/2009	
Title	Square Cube Dangler	
Priority NA		
Design Number	220727	
Class	23-01	
1)MAHESH GUPTA., H-35, SOUTH EXTEN. PART-1, NEW DELHI-110049, INDIA. 2)Mahesh Gupta.,		
Date of Registration	09/01/2009	
Title	Water Purifier	
Priority NA		
Design Number	221054	
Class	11-01	
1)RAJEEV MOHANDAS., SUNBEAMS, BILATHIKULAM ROAD, CALICUT-673 011, KERALA, INDIA. 2)Rajeev Mohandas		
Date of Registration	02/02/2009	
Title	Jewellery	
Priority NA		

Design Number	221179		
Class	26-02		
1)Crompton Greaves Limited 6th Floor, CG House, DR Annie Besant Road, Worli, Mumbai-400 030, Maharashtra, India.			
Date of Registration	12/02/2009		
Title	Lantern		
Priority NA			
Design Number	221180		
Class	26-02		
1)CROMPTON GREAVES LIMITED., 6TH FLOOR, CG HOUSE, DR ANNIE BESANT ROAD, WORLI, MUMBAI-400 030, MAHARASHTRA, INDIA.			
Date of Registration	12/02/2009		
Title	LANTERN		
Priority NA			
Design Number	221274		
Class	23-02		
1)Kohler France Sas Immeuble Le Cap, 3, Rue De Brennus, 93631 La Plaine St. Denis Cedex, France.			
Date of Registration	17/02/2009		
Title	Wash Basin		
Priority			
Priority Number	Date	Country	
000989314	20/08/2008	EUROPEAN UNION	

Design Number	221315		
Class	12-16		
1)Honda Motor Co., Ltd., 1-1, Minami-Aoyama 2-Chome, Minato-Ku, Tokyo, Japan.			
Date of Registration	19/02/2009		
Title	Front Side Fairing for Motorcycle		
Priority			
Priority Number	Date	Country	
2008-021389	21/08/2008	Japan	
Design Number	221351		
Class	12-16		
1)GM Global Technology Operations, Inc. 300 Renaissance Center, Detroit, Michigan 48265-3000, USA.			
Date of Registration	23/02/2009		
Title	Rear Bumper Of Car		
Priority			
Priority Number	Date	Country	
30-2008-0051087	27/11/2008	Korea(South)	
Design Number	221352		
Class	26-06		
1)GM Global Technology Operations, Inc. 300 Renaissance Center, Detroit, Michigan 48265-3000, USA.			
Date of Registration	23/02/2009		
Title	Rear Combination Lamp of Car		
Priority			
Priority Number	Date	Country	
30-2008-0050583	25/11/2008	Korea(South)	