



CONTINUED FROM PART 1

INTRODUCTION

In view of the recent amendment made in the Designs (Amendment) Rules, 2008 with effect from 17/06/2008, Publication of the matter relating to Designs is being published in the Official Journal of The Patent Office. This Journal is being published on weekly basis on every Friday covering the various proceedings on Designs as required according to the provisions of under Rule 22, 25, 27 and 39 of the Design (Amendment) Rules, 2008. All the enquiries on this Official Journal and other information as required by the public should be addressed to the Controller General of Patents, Designs & Trade Marks. Suggestions and comments are requested from all quarters so that the content can be enriched.

REGISTRATION OF DESIGNS

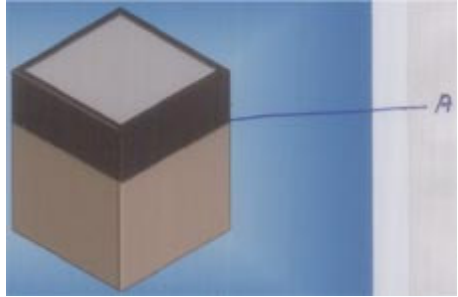

The following designs have been registered. They are now open for public inspection. In the following each entry the Date of Registration is shown. The Priority Number, Priority Date and Priority Country are also shown.

Design Number	206564		
Class	09-01		
1)French Cosmetics Pvt Ltd. Baroda, Jambusar N. High Way Road, At & Po. Dabhasa, Ta. Padra - 391440, Dist. Baroda (Gujarat), India			
Date of Registration	17/10/2006		
Title	Container		
Priority NA			
Design Number	210885		
Class	12-08		
1)Honda Motor Co., Ltd. 1-1, Minami-Aoyama 2-Chome, Minato-ku, Tokyo 107-8556, Japan			
Date of Registration	19/06/2007		
Title	Automobile		
Priority			
Priority Number	Date	Country	
2006-035217	22/12/2006	Japan	
Design Number	211951		
Class	11-01		
1)PUNITA TRRIKHA S-69, GREATER KAILASH, PART-1. 2)Punita Trrikha			
Date of Registration	20/08/2007		
Title	Pendant		
Priority NA			

Design Number	214849	
Class	12-11	
1)National Institute of Design Paldi, Ahmedabad-380007, Gujarat, India.		
Date of Registration	22/02/2008	
Title	Petrol Tank	
Priority NA		

Design Number	215082	
Class	06-13	
1)Eicher Goodearth Limited Eicher House, 12 Commercial Complex, Greater Kailash-Ii (Masjid Moth), New Delhi-110 048, India.		
Date of Registration	03/03/2008	
Title	Bed Spread	
Priority NA		

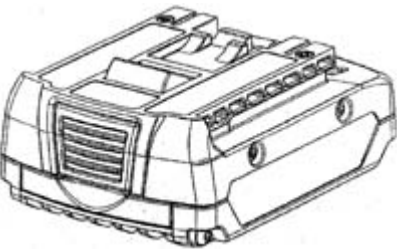
Design Number	215376	
Class	13-01	
1)Crompton Greaves Limited 6th Floor, CG House, Dr Annie Besant Road, Worli, Mumbai-400 030, Maharashtra, India.		
Date of Registration	19/03/2008	
Title	A Motor	
Priority NA		

Design Number	215790		
Class	13-02		
1)Robert Bosch GmbH Postfach 30 02 20, 70442 Stuttgart, Germany.			
Date of Registration	08/04/2008		
Title	Battery Packs for Portable Power Tools and Chargers		
Priority			
Priority Number	Date	Country	
000808092	08/10/2007	OHIM	
Design Number	215995		
Class	07-07		
1)Darshana Industries Pvt. Ltd. 63, Industrial Estate, Hadapsar, Pune-411 013, Maharashtra, India.			
Date of Registration	24/04/2008		
Title	Lock		
Priority NA			
Design Number	215998		
Class	08-07		
1)Darshana Industries Pvt. Ltd. 63, Industrial Estate, Hadapsar, Pune-411 013, Maharashtra, India.			
Date of Registration	24/04/2008		
Title	Swing Lock		
Priority NA			

Design Number	216365	
Class	14-03	
1)Samsung Electronics Co. Ltd. 416, Maetan-Dong, Yeongtong-Gu, Suwon-Si, Gyeonggi-Do, Korea.		
Date of Registration	16/05/2008	
Title	Mobile Phone	
Priority		
Priority Number	Date	Country
30-2007-0054149	28/12/2007	Korea(South)

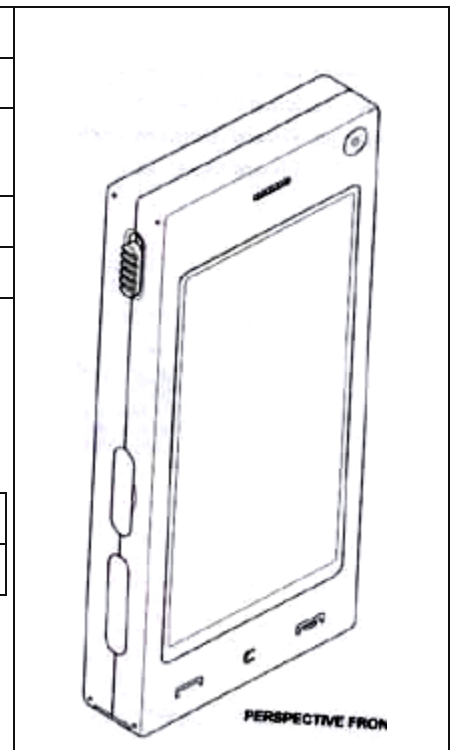

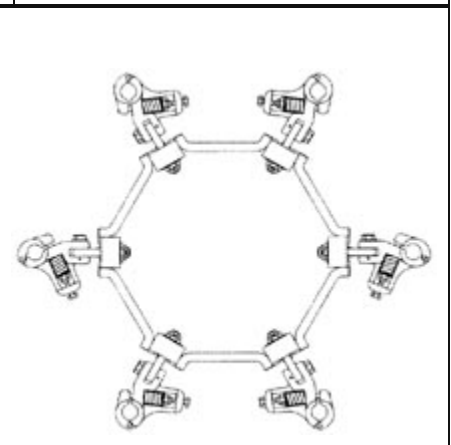

Design Number	216696	
Class	13-99	
1)Asahi Electric Works, Ltd., 2-11-16, Azamino-Minami, Aoba-Ku, Yokohama-Shi, Kanagawa-Ken, Japan.		
Date of Registration	16/06/2008	
Title	Spacer for Power Transmission Line Conductor	
Priority NA		

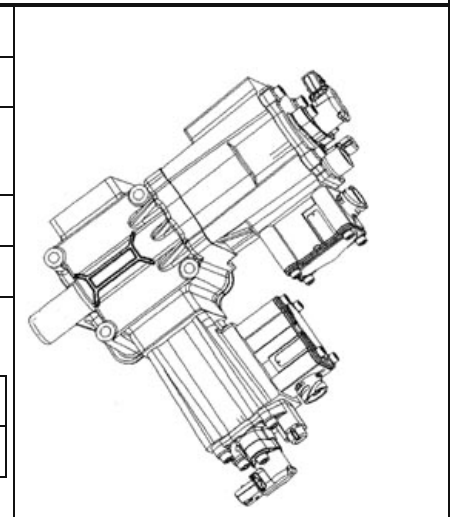

Design Number	216711	
Class	12-16	
1)Wabco Gmbh AM Lindener Hafen 21, 30453, Hannover, Germany.		
Date of Registration	16/06/2008	
Title	Gearbox Actuator	
Priority		
Priority Number	Date	Country
4 07 06 363.3	22/12/2007	Germany

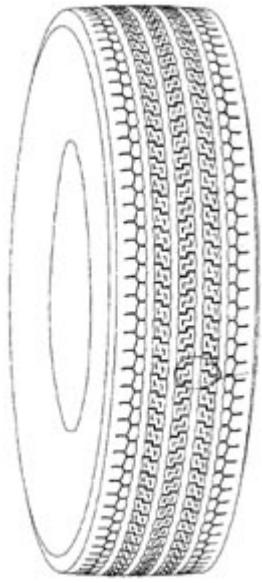
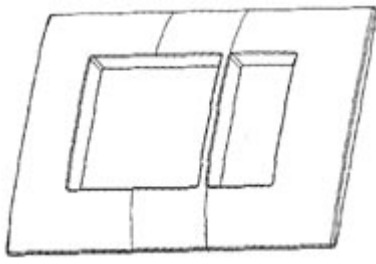

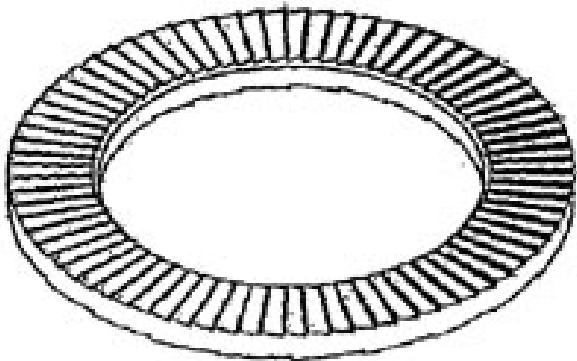
Design Number	216932		
Class	12-15		
1)Societate DE Technologie Michelin 23, RUE BRESCHET - F- 63000, CLERMONT-FERRAND, FRANCE.			
Date of Registration	30/06/2008		
Title	Tyre		
Priority			
Priority Number	Date	Country	
08/0043	03/01/2008	France	
Design Number			
216935			
Class	01-01		
1)Simon, S. A. Diputacion 390-392, 08013 Barcelona, Spain.			
Date of Registration	30/06/2008		
Title	Plates for Electrical Devices		
Priority			
Priority Number	Date	Country	
505829	21/01/2008	Spain	
Design Number			
217813			
Class	19-06		
1)Faber-Castell Aktiengesellschaft Nurnberger Strae 2, Stein Germany			
Date of Registration	14/08/2008		
Title	Pen		
Priority			
Priority Number	Date	Country	
000943345	30/05/2008	Germany	

Design Number	218153		
Class	08-00		
1)Nord-Lock AB Halabacken, SE-830 02, Mattmar, Sweden			
Date of Registration	27/02/2008		
Title	Locking Washer		
Priority			
Priority Number	Date	Country	
000886775	27/02/2008	EUROPEAN UNION	
Design Number	218322		
Class	21-01		
1)Maya Organic India Private Limited No. 25/1-4, 9th Cross, J. P. Nagar 2nd Phase, Bangalore 560078, Karnataka, India			
Date of Registration	01/09/2008		
Title	toy		
Priority NA			
Design Number	218453		
Class	12-15		
1)TVS Srichakra Limited 7B, West Veli Street, Madurai 625 001, Tamil Nadu India			
Date of Registration	08/09/2008		
Title	Tyre		
Priority NA			

Design Number	218522	
Class	19-02	
1)Max Co., Limited 6-6, Nihonbashi Hakozaiki-cho, Chuo-ku, Tokyo, Japan		
Date of Registration	11/09/2008	
Title	Stapler	
Priority		
Priority Number	Date	Country
2008-006426	14/03/2008	Japan

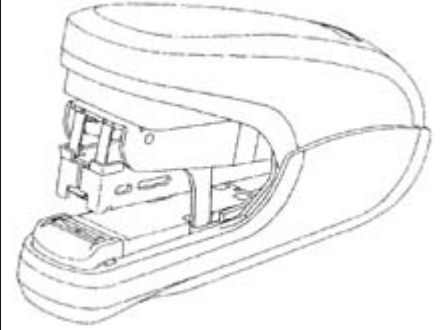







Design Number	218534	
Class	14-03	
1)Apple Inc. Cupertino, California 95014 United States of America		
Date of Registration	11/09/2008	
Title	Electronic Device	
Priority		
Priority Number	Date	Country
29/306,334	07/04/2008	U.S.A.







Design Number	218897	
Class	05-05	
1)Genesis Colors Pvt. Ltd. 1 A-2, Rao Tula Ram Marg, New Delhi-110022, India		
Date of Registration	30/09/2008	
Title	Saree	
Priority NA		



Design Number	219028	
Class	07-04	
1)M/s Ganesh Metal Industries 10, Samrat Industrial Area, B/h S.T. Work Shop, Opp. Satyanarayan Weigh Bridge, Nr. Gokuldharm, Rajkot Pin Code-360 004, Gujarat, India		
Date of Registration	10/10/2008	
Title	Appliances for Preparing Juice	
Priority NA		
Design Number	219056	
Class	13-03	
1)Ajanta Limited Orpat Industrial Estate, Rajkot Highway, P.B. No. 115, morbi-363 641, State of Gujarat, India		
Date of Registration	13/10/2008	
Title	Socket	
Priority NA		
Design Number	219081	
Class	13-03	
1)Ajanta Limited Orpat Industrial Estate, Rajkot Highway, P.B. No. 115, morbi-363 641, State of Gujarat, India		
Date of Registration	13/10/2008	
Title	Fan Regulator	
Priority NA		

Design Number	219083	
Class	13-03	
1)Ajanta Limited Orpat Industrial Estate, Rajkot Highway, P.B. No. 115, morbi-363 641, State of Gujarat, India		
Date of Registration	13/10/2008	
Title	Fuse	
Priority NA		
Design Number	219086	
Class	13-03	
1)Ajanta Limited Orpat Industrial Estate, Rajkot Highway, P.B. No. 115, morbi-363 641, State of Gujarat, India		
Date of Registration	13/10/2008	
Title	Fuse	
Priority NA		
Design Number	219095	
Class	13-03	
1)Ajanta Limited Orpat Industrial Estate, Rajkot Highway, P.B. No. 115, morbi-363 641, State of Gujarat, India		
Date of Registration	13/10/2008	
Title	Fuse	
Priority NA		

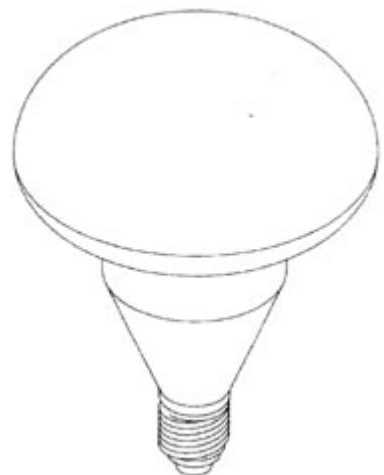
Design Number	219159	
Class	02-04	
1)Global Footwear & Leather Craft Industries No. 1, Ripon Street, Kolkata-700016, West Bengal, India		
Date of Registration	14/10/2008	
Title	Sole for Footwear	
Priority NA		
Design Number	219168	
Class	15-07	
1)LG Electronics India Private Limited Plot No. 51, Udyog Vihar, Surajpur-Kasana Road, Greater Noida-201 306 (U.P.), India		
Date of Registration	15/10/2008	
Title	Ice Cum Egg Tray	
Priority NA		
Design Number	219169	
Class	15-07	
1)LG Electronics India Private Limited Plot No. 51, Udyog Vihar, Surajpur-Kasana Road, Greater Noida-201 306 (U.P.), India		
Date of Registration	15/10/2008	
Title	Multi Utility Tray Made of Plastic	
Priority NA		

Design Number	219308	
Class	26-04	
1)Panasonic Corporation 1006, Oaza Kadoma, Kadoma-Shi, Osaka 571-8501, Japan		
Date of Registration	20/10/2008	
Title	Light Emitting Diode Lamp	
Priority NA		
Design Number	219324	
Class	07-04	
1)Kitchen Strainers & Tools (India) Pvt. Ltd. D-10-/35, Sector-8, Rohini, Delhi-110085 (India)		
Date of Registration	20/10/2008	
Title	Strainer	
Priority NA		
Design Number	219393	
Class	10-05	
1)Niranjan Suresh Bhatwal "Sinic House", Behind Gurudwara, Mumbai Road, Dhule 424 311, State of Maharashtra, India		
Date of Registration	22/10/2008	
Title	Bank Note Dectector	
Priority NA		

Design Number	219497	
Class	12-16	
1)Scania CV AB SE-221 88, Lund, Sweden		
Date of Registration	07/05/2008	
Title	Battery Box Cover	
Priority		
Priority Number	Date	Country
2008/0280	07/05/2008	Sweden



Design Number	219508	
Class	05-05	
1)Charming Apparels (P) Ltd. 402-405, 1st Floor, Main Road, Chandni Chowk, Delhi-110006, India		
Date of Registration	03/11/2008	
Title	Textile Fabric	
Priority NA		



Design Number	219517	
Class	13-02	
1)Jye Chuang Electronic Co. Ltd. 1F, No. 2, Lane 292, Sec. 1, Datong Rd, Sijhih City, Taipei Country 221, Taiwan, R. O. C.		
Date of Registration	31/10/2008	
Title	Charger	
Priority NA		

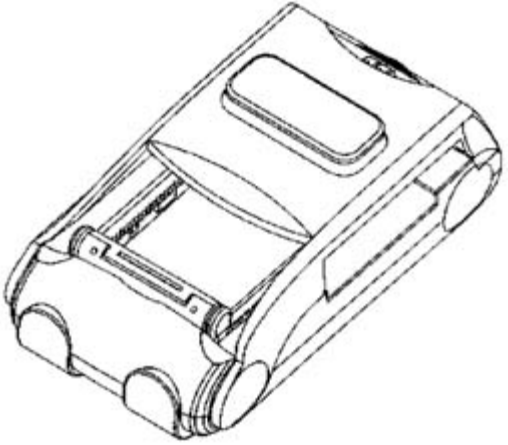





Design Number	219529	
Class	08-06	
1)M/s Suyash Industries 18, Atika Industrial Area, Dhebar Road South, Rajkot-360 002, Gujarat, India		
Date of Registration	04/11/2008	
Title	Handle	
Priority NA		
Design Number	219554	
Class	19-02	
1)Niranjan Suresh Bhatwal "Sinic House", Behing Gurudwara, Mumbai Road, Dhule 424 311, State of Maharashtra, India		
Date of Registration	05/11/2008	
Title	Loose Note Counting Machine	
Priority NA		
Design Number	219555	
Class	23-01	
1)Sono Technology and Research Ltd. Mahatabuddin Road, Courtpara, Kushita-7000, Bangladesh		
Date of Registration	05/11/2008	
Title	Filter for Removing Arsenic from Water	
Priority NA		

Design Number	219567	
Class	24-02	
1)Vision Medical Devices (India) Pvt. Ltd. Plot No. 586, Industrial Phase 9, Mohali (Punjab), India		
Date of Registration	06/11/2008	
Title	Laryngoscope Blade	
Priority NA		

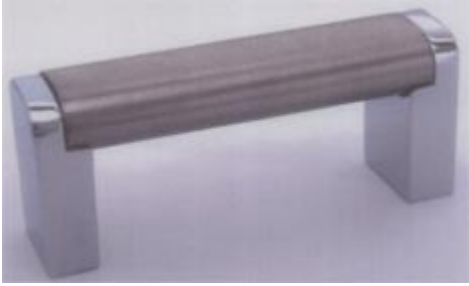
Design Number	219573	
Class	09-01	
1)Brabantia Nederland B. V. Brabantiaalaan 3, BP Waalre, The Netherlands		
Date of Registration	06/11/2008	
Title	Soap Dispenser	
Priority NA		

Design Number	219648	
Class	08-09	
1)Shree Harikrupa Die Casting K-1, 242/17, b/h, Mel-Tech, Nr. Turbo Bearing, Aji Vasahat GIDC, Pin-360002, Rajkot, India		
Date of Registration	11/11/2008	
Title	Door Magnet	
Priority NA		

Design Number	219798	
Class	08-06	
1)M/s Nevil Interprise 80 Feet Road, Behind K. Rasiklal, 5 Ramnagar, Rajkot-360 003, Gujarat State, India		
Date of Registration	21/11/2008	
Title	Handle	
Priority NA		
Design Number	219804	
Class	08-06	
1)M/s Nevil Interprise 80 Feet Road, Behind K. Rasiklal, 5 Ramnagar, Rajkot-360 003, Gujarat State, India		
Date of Registration	21/11/2008	
Title	Handle	
Priority NA		
Design Number	219922	
Class	05-05	
1)Charming Apparels (P) Ltd. 402-405, 1st Floor, Main Road, Chandni Chowk, Delhi-110006, India		
Date of Registration	01/12/2008	
Title	Textile Fabric	
Priority NA		

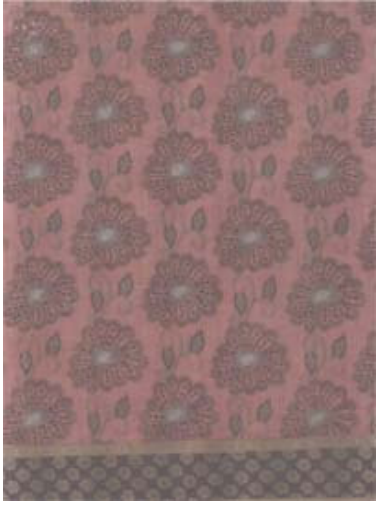
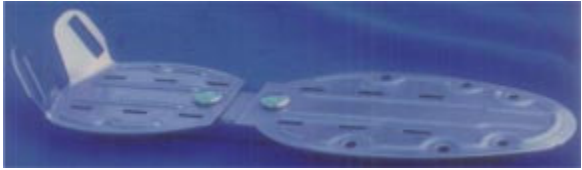

Design Number	219935	
Class	05-00	
1)Charming Apparels (P) Ltd. 402-405, 1st Floor, Main Road, Chandni Chowk, Delhi-110006, India		
Date of Registration	01/12/2008	
Title	Textile Fabric	
Priority NA		
Design Number	219936	
Class	05-05	
1)Charming Apparels (P) Ltd. 402-405, 1st Floor, Main Road, Chandni Chowk, Delhi-110006, India		
Date of Registration	01/12/2008	
Title	Textile Fabric	
Priority NA		
Design Number	220423	
Class	21-02	
1)EM CEE CEE Sports Agencies (P) Ltd. Jonex House, Sodal Road, Jalandhar-144 004, (Punjab), India		
Date of Registration	23/12/2008	
Title	Foot-Plate for Roller Skate	
Priority NA		

Design Number	220424	
Class	12-16	
1)Rajesh Enterprises 211-B, Industrial Estate, Ludhiana-3 (Punjab) India.		
Date of Registration	23/12/2008	
Title	Hub-Cone for Bicycle	
Priority NA		
Design Number	220449	
Class	06-06	
1)Prince Enterprise 80 Feed Road, 5/8 Ramnagar, Behind K. Rasiklal, Rajkot-360003, Gujarat, India		
Date of Registration	24/12/2008	
Title	Sofa Leg	
Priority NA		
Design Number	220451	
Class	06-06	
1)Prince Enterprise 80 Feet Road, 5/8 Ramnagar Behind K. Rasiklal, 5 Ramnagar, Rajkot-360003, Gujarat State, India		
Date of Registration	24/12/2008	
Title	Sofa Leg	
Priority NA		

Design Number	220452	
Class	06-06	
1)Prince Enterprise 80 Feet Road, 5/8 Ramnagar Behind K. Rasiklal, 5 Ramnagar, Rajkot-360 003, Gujarat State, India		
Date of Registration	24/12/2008	
Title	Sofa Leg	
Priority NA		
Design Number	220453	
Class	08-09	
1)Prince Enterprise 80 Feet Road, 5/8 Ramnagar Behind K. Rasiklal, 5 Ramnagar, Rajkot-360 003, Gujarat State, India		
Date of Registration	24/12/2008	
Title	Door Magnet	
Priority NA		
Design Number	220454	
Class	08-09	
1)Prince Enterprise 80 Feet Road, 5/8 Ramnagar Behind K. Rasiklal, 5 Ramnagar, Rajkot-360 003, Gujarat State, India		
Date of Registration	24/12/2008	
Title	Door Magnet	
Priority NA		

Design Number	220455	
Class	08-08	
1)Prince Enterprise 80 Feet Road, 5/8 Ramnagar Behind K. Rasiklal, 5 Ramnagar, Rajkot-360 003, Gujarat State, India		
Date of Registration	24/12/2008	
Title	Curtain Socket	
Priority NA		
Design Number	220461	
Class	08-06	
1)Die-Cast Industries Plot No. 209/210, N, Road, Aji G. I. D. C. Phase-II, Rajkot- 360003, Gujarat State, India		
Date of Registration	24/12/2008	
Title	Handle	
Priority NA		
Design Number	220462	
Class	08-06	
1)Die-Cast Industries Plot No. 209/210, N, Road, Aji G. I. D. C. Phase-II, Rajkot-360003, Gujarat State, India		
Date of Registration	24/12/2008	
Title	Handle	
Priority NA		

Design Number	220463	
Class	08-06	
1)Die-Cast Industries Plot No. 209/210, N, Road, Aji G. I. D. C. Phase-II, Rajkot-360003, Gujarat State, India		
Date of Registration	24/12/2008	
Title	Handle	
Priority NA		
Design Number	220464	
Class	08-06	
1)Die-Cast Industries Plot No. 209/210, N, Road, Aji G. I. D. C. Phase-II, Rajkot-360003, Gujarat State, India		
Date of Registration	24/12/2008	
Title	Handle	
Priority NA		
Design Number	220465	
Class	08-06	
1)Die-Cast Industries Plot No. 209/210, N, Road, Aji G. I. D. C. Phase-II, Rajkot-360003, Gujarat State, India		
Date of Registration	24/12/2008	
Title	Handle	
Priority NA		

Design Number	220466	
Class	08-06	
1)Die-Cast Industries Plot No. 209/210, N, Road, Aji G. I. D. C. Phase-II, Rajkot-360003, Gujarat State, India		
Date of Registration	24/12/2008	
Title	Handle	
Priority NA		
Design Number	220467	
Class	08-06	
1)Die-Cast Industries Plot No. 209/210, N - Road, Aji G. I. D. C. Phase-II, Rajkot-360003, Gujarat State, India		
Date of Registration	24/12/2008	
Title	Handle	
Priority NA		
Design Number	220468	
Class	08-06	
1)Die-Cast Industries Plot No. 209/210, N - Road, Aji G. I. D. C. Phase-II, Rajkot-360003, Gujarat State, India		
Date of Registration	24/12/2008	
Title	Handle	
Priority NA		

Design Number	220471	
Class	08-06	
1)Die-Cast Industries Plot No. 209/210, N - Road, Aji G. I. D. C. Phase-II, Rajkot-360003, Gujarat State, India		
Date of Registration	24/12/2008	
Title	Handle	
Priority NA		

Design Number	220494	
Class	13-03	
1)M/s V-Guard Industries Ltd. 44/875, Little Flower Church Road, Kaloore, Kochi-682017, Kerala State, India		
Date of Registration	26/12/2008	
Title	Stabilizer	
Priority NA		

Design Number	220942	
Class	24-01	
1)Pricol Limited P. B. No. 6331, (1087-A), New No. 702/7, Avanashi Road, Coimbatore -641 037, Tamil Nadu, India		
Date of Registration	28/01/2009	
Title	Humidifying Chamber	
Priority NA		

Design Number	221017		
Class	12-11		
1)Honda Motor Co., Ltd. 1-1, Minami-Aoyama 2-Chome, Minato-ku, Tokyo 107-8556, Japan			
Date of Registration	02/02/2009		
Title	Motor Scooter		
Priority			
Priority Number	Date	Country	
2008-020393	06/08/2008	Japan	
Design Number	221177		
Class	26-02		
1)Crompton Greaves Limited 6th Floor, CG House, Dr Annie Besant Road, Worli, Mumbai-400 030, Maharashtra, India.			
Date of Registration	12/02/2009		
Title	Lantern		
Priority NA			